

Radio ^{IND} Electronics

TELEVISION • SERVICING • HIGH FIDELITY

MICHAEL GERNSBACK Editor in Chief

A GERNSBACK PUBLICATION

Identifying Transistor Characteristics Fuel Cells and the Electronic Car

Special Build-It Projects
Articles on Components

**BUILD:
ELECTRONIC
IGNITION**
for less than \$25!

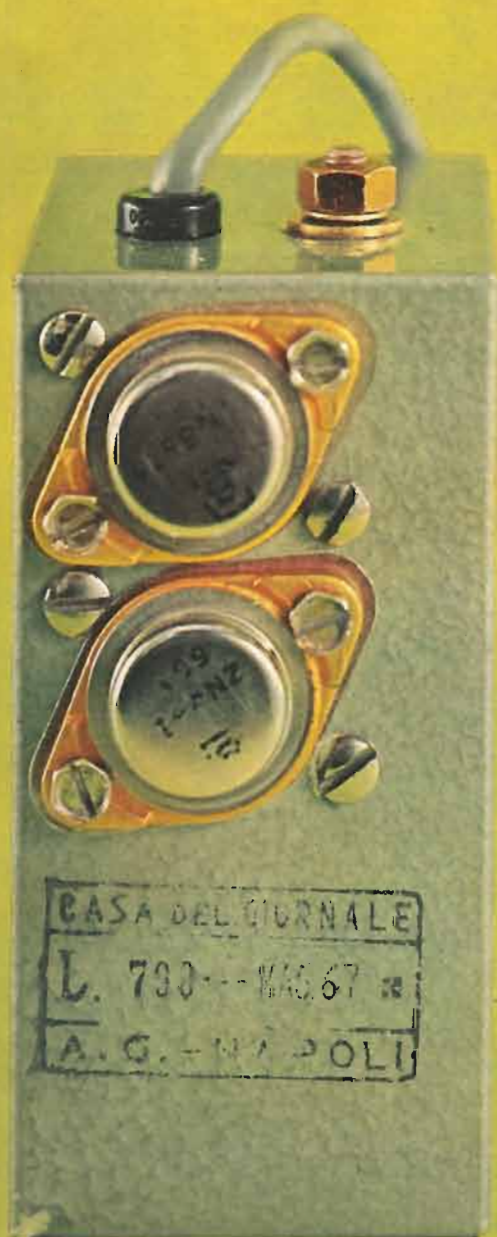

TRIPLETT

EXTRA QUALITY IS HIDDEN*

MODEL 630 V-O-M PRICE † \$58⁰⁰

Standard Of The Industry



USES UNLIMITED:

- Field Engineers
- Application Engineers
- Electrical, Radio, TV, and Appliance Servicemen
- Electrical Contractors
- Factory Maintenance Men
- Industrial Electronic Maintenance Technicians
- Home Owners, Hobbyists

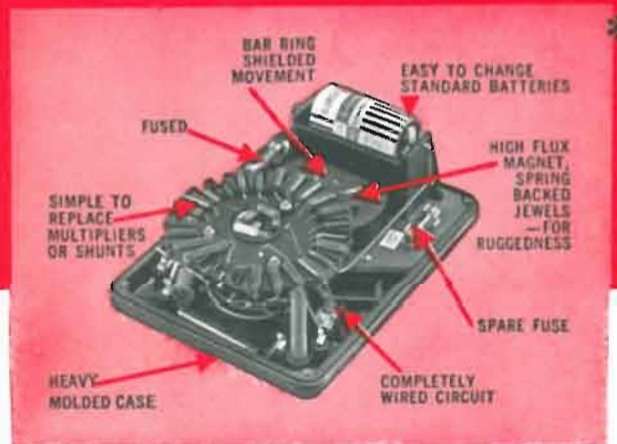

FACTS MAKE FEATURES:

- 1** Popular streamlined tester with long meter scales arranged for easy reading. Fuse protected.
- 2** Single control knob selects any of 32 ranges—less chance of incorrect settings and burnouts.
- 3** Four resistance ranges—from .1 ohm reads direct; 4½ ohm center scale; high 100 megohms.

Attention to detail makes the Triplet Model 630 V-O-M a lifetime investment. It has an outstanding ohm scale; four ranges—low readings .1 ohm, high 100 megs. Fuse affords extra protection to the resistors in the ohmmeter circuit, especially the XI setting, should too high a voltage be applied. Accuracy 2% DC to 1200V. Heavy molded case.

†630A same as 630 plus 1½% accuracy and mirror scale only \$68⁰⁰

TRIPLETT ELECTRICAL INSTRUMENT COMPANY, BLUFFTON, OHIO

RANGES

DC VOLTS	0-3-12-60-300-1,200-6,000 at 20,000 ohms per volt.
AC VOLTS	0-3-12-60-300-1,200-6,000 at 5,000 ohms per volt.
OHMS	0-1,000-10,000.
MEG OHMS	0-1-100.
DC MICRO AMPERES	0-60 at 250 millivolts.
DC MILLI-AMPERES	0-1.2-12-120 at 250 millivolts.
DC AMPERES	0-12.

Ohm - 20 to +77 (600 ohm line at 1 MW)

OUTPUT VOLTS: 0-3-12-60-300-1,200, jack with condenser in series with AC ranges.



THE WORLD'S MOST COMPLETE LINE OF V-O-M'S. AVAILABLE FROM YOUR TRIPLETT DISTRIBUTOR'S STOCK.

Be the man who's always
first to say: "I've got
the answer right here!"



START USING THIS REMARKABLE

ELECTRONICS SLIDE RULE

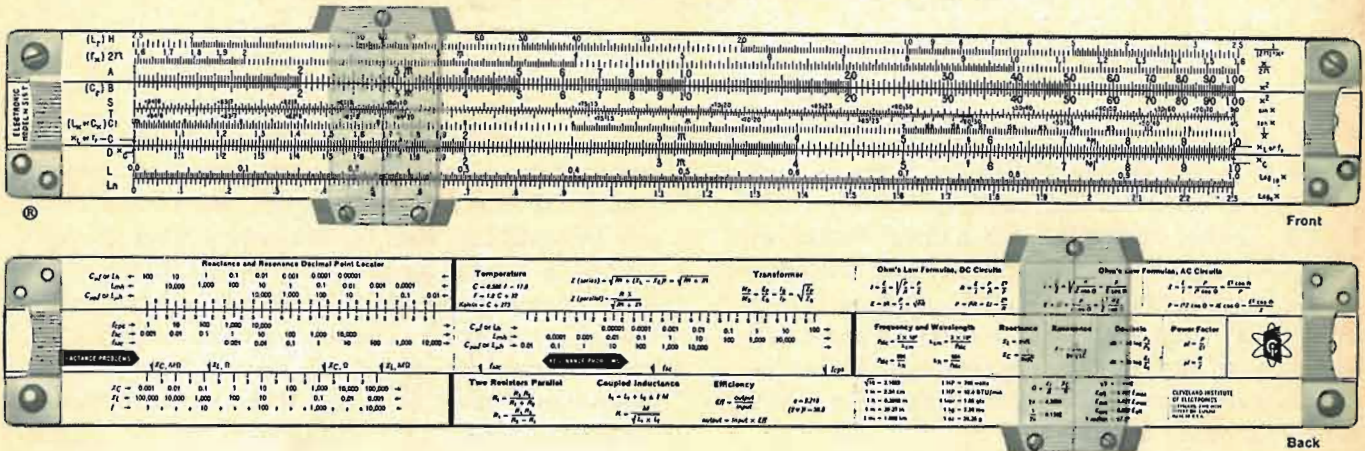

SOME DAY EVERYONE in electronics may have a slide rule like this. Till then, the man who uses one will seem like a wizard as he solves reactance and resonance problems in 12 to 20 seconds—without pencil and paper.

This is a professional slide rule in every detail, a full 10" long, made exclusively for Cleveland Institute of Electronics, to our rigid specifications, by Pickett, Inc. It can be used for conventional computation as well as special electronics calculations. All-metal construction assures smooth operation regardless of climate.

Handsome top-grain leather carrying case has heavy-duty plastic liner to protect slide rule; removable belt loop for convenient carrying. "Quick-flip" cover makes it easy to get rule in and out of case.

You also get four full-length **AUTO-PROGRAMMED™ Lessons**, which teach you how to use the special electronics scales on the slide rule. These lessons have been carefully designed to meet the same high educational standards as the electronics career courses for which our school is famous. Even if you've never used a slide rule before, you'll soon whiz through the toughest problems with this CIE rule.

Deliberately underpriced. Many men in electronics have told us that this unique slide rule, leather case, and 4-lesson course easily add up to a \$50 value. But we have deliberately underpriced it at less than \$25. Why? Our reason is simple: we are looking for men in electronics who are ambitious to improve their skills...who know that this will require more training. If we can attract you with the low price of our slide rule and course—and impress you with its quality—you are more

likely to consider CIE when you decide you could use more electronics training.

Send for free booklet. See for yourself why this amazing slide rule and course have made such a big hit with busy electronics men everywhere. No obligation, of course—just an opportunity to get in on the best offer ever made to people in electronics. Just mail coupon, or write Cleveland Institute of Electronics, Dept. RE-136, 1776 East 17th St., Cleveland, Ohio 44114.

CIE Cleveland Institute of Electronics
1776 East 17th Street, Cleveland, Ohio 44114

MAIL THIS COUPON FOR **FREE BOOKLET**

Cleveland Institute of Electronics
1776 East 17th Street Cleveland, Ohio 44114

Please send me without charge or obligation your booklet describing CIE Electronics Slide Rule and Instruction Course. **ALSO FREE** if I act at once: a handy pocket-size Electronics Data Guide.



Name _____ (please print)

Address _____

City _____ State _____ Zip _____



Accredited Member National Home Study Council
A Leader in Electronics Training... Since 1934

RE-136

Circle 8 on reader's service card

Psychology of Pay TV

Pay television, or subscription TV as the FCC calls it. Service technicians fear it, so their associations fight it. Theater owners see it as a threat to their own prosperity, so they battle it viciously. City councils use it as a reason for blocking CATV franchises. Until recently, Hollywood film producers viewed it suspiciously, torn between attractive fees offered by pay TV and possible loss of theater outlets if top films were sold for first-run showing on pay TV.

On the other hand, much of the bickering about pay TV has to do with the viewers. Proponents insist that audiences will gladly pay to watch high-quality movies uninterrupted by commercials. Opponents argue that viewers are unlikely to pay extra for TV entertainment they can now have "for free." Pay-TV companies say the experiment that has been going on in Hartford, Conn., for the last 4 years proves customers will pay; opponents claim just as seriously that the Hartford experiment proves they won't.

It isn't likely there will ever be any actual agreement on any of these points. Like CATV, pay TV will live or die according to whether or not the viewers actually do want it. If they don't, pay TV will have been just another temporary fancy.

There are, however, some questions about pay TV, about certain psychological aspects of the medium, that are worth looking into. These psychological factors themselves generate arguments, but they should be considered in any thorough evaluation of pay TV.

One factor is the "pay for it and it's better" syndrome, based on the assumption that no one appreciates anything that is free. Viewers therefore disparage the quality of programs they now get on TV (while watching them insatiably), call the commercials lousy, and grumble that TV is the country's great time-waster. *Question:* Would they think the fare was better if they were paying for it directly?

Viewing habits will be important to final acceptance of pay TV. Through the last 15 years, TV audiences have grown accustomed to breaks for commercials. They use the time to pour another beer, eat a

snack or two, or pop some popcorn. Some simply stretch and relax from the wearying tension of continuous TV-watching. With this rest-period habit now well formed, how many long-time TV owners sit in a movie theater uneasily and restlessly (though perhaps unconsciously) waiting for the commercial breaks they know aren't coming? Children (and—face it—some adults) enjoy commercials. *Question:* Will 15 years of seeing commercials in regular break-spots be brushed aside in favor of 1½- and 2-hour uninterrupted programs?

Cable TV (CATV) is another factor, despite its owners' disclaimers. Though aired pay TV is practical, it is easier to pipe pay-TV programs down the community wire. CATV customers get a bill each month anyway, the reasoning might go, so a few extra dollars for special programs would be hardly noticeable. *Question:* Will CATV subscribers pay this added cost when they already pay a monthly fee for their TV enjoyment?

First-run movies have already come to ordinary TV. In a recent week, there were eight movies under 4 years old, six of them in color; there were also nearly two dozen popular ones from the 1950's. Recent top theater attractions are even now being bought up by the three TV networks. *Question:* With top-grade movies available on "free" TV soon after (or even before) their release to theaters, will viewers spend money to see similar fare on pay TV?

In last month's editorial, I pointed out the extremely low cost of owning a TV receiver. This cost is necessary no matter what the program source, so the pay-TV fee is simply extra. *Question:* Will viewers pay twice (CATV viewers three times) to watch top-grade programs on TV?

The answers to all these questions haven't yet been determined. Time alone will tell. But they and many others will have to be answered before pay TV becomes the rule rather than the experimental exception.

Forrest H. Belt

Radio-Electronics

February 1967 VOL. XXXVIII No. 2
Over 55 Years of Electronic Publishing

EDITORIAL

- 2 Psychology of Pay TV Forest H. Belt

COMPONENTS

- 32 Solid-State C-D Ignition Under \$25 Brice Ward
An efficient but economical system
- 35 Cartridge Systems and Quality Leonard Silke
Phono reproducers are getting sophisticated
- 38 Circuit-Breaker Testing Jack Darr
How do you know there's an overload in the receiver?
- 51 Need A Power Resistor? Try A Transistor Clement S. Pepper
A variable dummy load is useful for experiments
- 55 Nonpolarized Zener Clipper 
One diode does the job of two
- 56 Double Feature, Starring Timers Frederick W. Chesson
A pair of automatic, variable-duration control circuits
and Ronald L. Ives
- 60 Battery Selection Guide
Can't decide which battery to use? Find out how to choose the right one

GENERAL

- 40 Digital-To-Analog Fundamentals Irwin Math
There are two ways to measure electronically, and this article explains both
- 44 Fuel Cells—Power for Tomorrow Allen B. Smith
Batteries of the future promise more efficiency, less weight
- 49 Technician to Technical Writer Fred W. Holder
Trading that solder gun in for a pencil can increase your income
- 67 Equipment Report: Lafayette HB-525
CB Transceiver
- 93 R-E Puzzler Answer

TELEVISION

- 42 Lucky Hunts Horizontal Hold Wayne Lemons
... and eventually finds it
- 72 The Trouble That Couldn't Happen Milton Lowens
How and why it did

AUDIO—HIGH-FIDELITY—STEREO

- 47 Hi-Fi, Hi-Fi, All Around the House
Wall-to-wall stereo in every room
- 52 The Audio Man's Audio System Thomas R. Haskett
How the professionals do it
- 68 Equipment Report: Knight-Kit KG-895
All-Transistor Stereo

TEST INSTRUMENTS

- 22 Service Clinic Jack Darr
In the Shop... With Jack
- 70 Equipment Report: PACE 5803 Laboratory
Power Supply

THE DEPARTMENTS

- | | |
|---|--------------------------|
| 14 Correspondence | 92 Noteworthy Circuits |
| 93 New Books | 74 Technotes |
| 86 New Literature | 88 Try This One |
| 79 New Products | 43 What's Your EQ? |
| 75 New Semiconductors,
Microcircuits & Tubes | 91 50 Years Ago |
| 4 News Briefs | 76 Reader's Service Page |

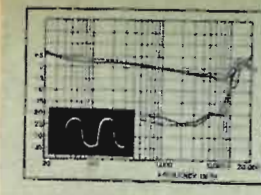

p 35—CARTRIDGES

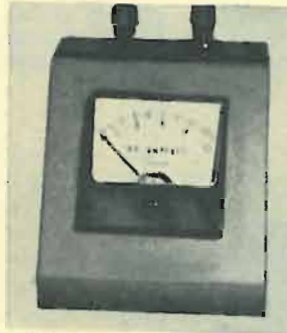

p 38—BREAKER TESTS

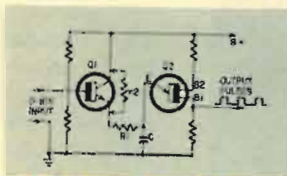

p 40—COMPUTER TALK



p 49—TECH WRITER



p 42—SERVICE HINTS



p 47—HOME STEREO

p 52—SUPER AUDIO



RADIO-ELECTRONICS, FEBRUARY 1967, Volume XXXVIII, No. 2. Published monthly by Gernsback Publications, Inc., at Ferry St., Concord, N. H. 03302. Editorial, Advertising, and Executive offices: 154 West 14th Street, New York 10011. Circulation Office, Boulder, Colo. 80302.

Second-class postage paid at Concord, N. H. Printed in U.S.A. One-year subscription rate: U. S. and possessions, Canada, \$5. Pan-American countries, \$6. Other countries, \$6.50. Single copies: 60c. © 1967, by Gernsback Publications, Inc. All rights reserved. POSTMASTERS: Notices of undelivered copies (Form 3579) to Boulder, Colo. 80302.

COVER FEATURE



p 32—Easy to build and install, this capacitor-discharge ignition system uses the popular silicon-controlled rectifier to furnish the high current and rapid switching necessary.

FUEL CELLS



p 44—Useful in outer space or on terra firma, these modern power packages seem to be the answer to problems being encountered in the search for portable power.



Member,
Institute of High Fidelity.
Radio-Electronics is indexed in
*Applied Science & Technology
Index (formerly Industrial
Arts Index)*

NEWS BRIEFS

FIRST SOLID-STATE TV CAMERA PICKUP "TUBE"



Semiconductors invaded one of the last few pockets of vacuum-tube domain recently. A substitute for the conventional TV camera pickup tube has been built by RCA. The sensing device consists of four glass slides, each an inch square, which contain networks of 132,000 thin-film elements. Light from the scene falls on an area containing 32,400 microscopic dots of photoconductive material.

The supporting circuitry includes 540 thin-film transistors, which are used for horizontal and vertical scanning of the image, as well as other control functions.

The camera—completely solid-state and containing a transmitter and antenna—is shown in the photo being held by its developer, Dr. Paul K. Weimer. He says the organization and readout of the photoconductive dots in the sensing array are much like the readout of a standard computer memory. Hence it's possible to send pictures from the camera directly to a computer for processing or storage.

ELECTRIC BIKE

With GM and Ford working on developmental models of electric-powered automobiles and trucks, it remained only for somebody to come up

with a battery-driven motorcycle. Union Carbide Corp. has done just that. The motorbike, which was demonstrated recently in New York City, uses a fuel-cell battery which obtains its energy from hydrazine fuel, and oxygen drawn from the air. The vehicle can run over 200 miles on a gallon of fuel, and has a top speed of 25 mph.

Electric-powered vehicles are viewed by many as a partial solution to the urban air-pollution problem. The electric bike is not only fumeless, but occupies little space, thus reducing traffic congestion, too.

JACK BEEVER DEAD AT 51

A fatal heart attack felled one of the electronics industry's most widely talented and well known engineers.

Jack Beever was a pioneer in the CATV, MATV, and ETV fields. Though only a high-school graduate, he had educated himself sufficiently to develop electronic medical equipment, such as X-ray and EKG gear. He engineered large parabolic antennas, played piano and organ, and was an expert on sound reproduction.

He served as a member of the Presidential Advisory Committee to the FCC for the development of all-

channel broadcasting. Later, he was director of the FCC tests in New York City to determine the feasibility of UHF in metropolitan areas.

Beever was the author of more than 50 published technical articles and papers, as well as several books. At his death (last November 25) he was technical director of Jerrold Electronics Corp.

FAST-FORWARD CAR TAPE

Sometime in 1967, automobile cartridge-tape players will be available with a fast-forward speed. This feature will do much to enhance the popularity of taped music in cars, as a listener can select the musical number he wants, skipping others.

The fast forward feature appears on both mono and stereo units produced by Lear Stereo Division, Lear Jet Corp.

WHAT HAPPENED TO THE 21-INCH TV?

It's still around, but now they call it "a 212-square-inch picture." The change in definition is due to a ruling, effective January 1, 1967, by the Federal Trade Commission. The regula-

TINY, TINY TV



While it may not be seen in the U.S. for a while, a British firm's "Microvision" is only a handful of television. Even with power supply (six penlight cells), the unit weighs only 10½ oz, and measures only 4 × 2½ × 2 inches. It uses a specially developed CRT with a 2-inch screen. The picture tube has a 70° deflection angle and a neck length of only ¼ inch.

The "Microvision" uses 30 transistors, both silicon and germanium epitaxial planar types. Battery drain is low—the entire circuit takes only 450 mW—less than the CRT heater drain in many small-screen sets. Another special component is the speaker, which is piezoelectric rather than magnetic. It has a 2-inch cone.

The receiver is manufactured and sold (for about \$144) in Great Britain by Sinclair Radionics, Ltd.

ELECTRONICS

WHERE CAN YOU EQUAL THIS OPPORTUNITY

TO EARN A GOOD PAYING JOB IN A FAST GROWING FIELD?

DeVRY'S "BIG 3" AIDS TO PROGRESS ARE DESIGNED TO SPEED YOU QUICKLY TO A REAL FUTURE IN ELECTRONICS

1. EFFECTIVE TRAINING!
Learn **AT HOME** in spare time, or day or evening in one of our **RESIDENT SCHOOLS**.

2. INDUSTRY RECOGNITION!
DeVry programs, prepared with industry's help, are **"JOB-AIMED."**

3. EMPLOYMENT SERVICE!
for **ALL** graduates through our contacts with many large, respected companies across North America.

ELECTRONICS is one field that spells OPPORTUNITY in big capital letters for many men 18 to 45. This widespread but FAST GROWING field offers trained men some of today's finest, good-paying job opportunities — or a chance to start a profitable servicing shop!

Even if you don't have previous technical experience or an advanced education, DeVry's "BIG 3" aids to progress may very well be YOUR stepping stones to a BETTER FUTURE. You can learn at home in your spare time, while keeping your present job. Or, in a day or evening program in our U.S. or Canadian resident school, you can develop the very skills needed to make wonderful progress. We even work to get resident students part-time jobs to help with tuition or living expenses, if necessary!

Regardless of how you complete your educational program with DeVry, you can count on industry-recognized, effective training aimed directly at providing on-the-job-type "know-how." This is followed by actual EMPLOYMENT SERVICE to help you get started in Electronics. Or, if you are in the field already, remember that a DeVry recommendation has meant plenty of ADDED DOLLARS in income to many who made themselves more valuable to employers.

See for yourself how you, too, may prepare for the INCOME, the PRESTIGE and the FINE FUTURE that goes with the title of Electronics Technician. Mail the coupon NOW for facts without obligation.

WE PREPARE YOU NOT FOR ONE JOB BUT FOR JOBS IN MANY DIVISIONS OF THE FASCINATING FIELD OF ELECTRONICS



SPACE & MISSILE



TV — RADIO



RADAR



MICROWAVES

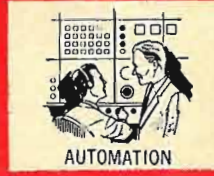

AUTOMATION



COMMUNICATIONS



COMPUTERS



BROADCASTING

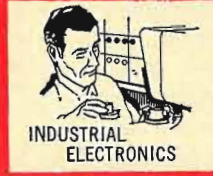

INDUSTRIAL ELECTRONICS



ELECTRONIC CONTROL

MOVIES, TEXTS AND EQUIPMENT HELP YOU LEARN FASTER



DeVry includes training movies **AT HOME**, "programmed" texts and many shipments of Electronic parts — to help you learn quickly, remember more.

FREE

Send coupon for these two factual booklets **NOW!**



MAIL COUPON TODAY!

DeVRY TECHNICAL INSTITUTE
4141 Belmont Avenue, Chicago, Ill. 60641

Dept. RE-2-X

Please give me your two free booklets, "Pocket Guide to Real Earnings," and "Electronics in Space Travel"; also include details on how to prepare for a career in Electronics. I am interested in the following opportunity fields (check one or more):

- | | |
|--|---|
| <input type="checkbox"/> Space & Missile Electronics | <input type="checkbox"/> Communications |
| <input type="checkbox"/> Television and Radio | <input type="checkbox"/> Computers |
| <input type="checkbox"/> Microwaves | <input type="checkbox"/> Broadcasting |
| <input type="checkbox"/> Radar | <input type="checkbox"/> Industrial Electronics |
| <input type="checkbox"/> Automation Electronics | <input type="checkbox"/> Electronic Control |

Name _____ Age _____

Address _____ Apt. _____

City _____ State _____ Zip _____
Code _____

Check here if you are under 16 years of age.

HOME STUDY AND RESIDENT SCHOOL TRAINING AVAILABLE IN CANADA

2101

DeVry Technical Institute

4141 Belmont Avenue
Chicago, Illinois 60641

Accredited Member of National Home Study Council



Don't
buy Sony tape
just to get the
amazing new

**"Easy Threader"
tab!**

It is a fact that each reel of Sony Professional Recording Tape contains two "easy threader" tabs which make any tape reel instantly and effortlessly self-threading. □ But Sony (maker of the best-selling tape recorders in the world) also makes the world's finest recording tape. And we'd rather have you buy it for that reason!

Sony tape captures the strength and delicacy of any sound. Sony tape reproduces those sounds for perfect playback, over and over again. □ Sony Professional Recording Tape brings out the best in a tape recorder.

And that's why we'd like you to buy it.

SONY SUPERSCOPE®

AMERICA'S FIRST CHOICE IN TAPE RECORDERS
Circle 10 on reader's service card

NEWS BRIEFS continued

tion affects all TV's sold or shipped in interstate commerce. Advertisers may no longer quote screen diameter. Only diagonal measurement or the viewable area of the picture tube in square inches may be used to describe a receiver.

How to convert 212 square inches to a 21-inch picture? Here's an easy way:

$$D = 2.5 \sqrt{\frac{A}{3}}$$

A is the screen area in square inches, and D is the diagonal measurement in inches—what you want. Remember this method is not perfectly accurate, since no CRT has a perfect 4:3 aspect ratio (which is what the TV station transmits). Also, there are variations in exact screen size and masked area from one receiver to another. The following table shows the nominal diagonal, the area, and finally the value of diagonal actually computed from the area by means of the formula:

Nominal diagonal (inches)	Area (Square inches)	Computed diagonal (inches)
3	4½	3.1
4	8	4.1
5	12	5.0
7	24	7.1
9	40	9.1
11	60	11.2
12	72	12.2
14	98	14.3
15	111	15.2
16	126	16.2
17	143	17.3
19(b-w)	172	18.9
19(color)	180	19.4
21(b-w)	212	21.0
21(color)	226	21.7
23(b-w)	260	23.3
23(color)	280	24.2
25	300	25.0
27	350	27.0
30	440	30.3

The difference in area between black-and-white and color CRT's is due to usual differences in receiver masking. If you find a screen-area figure not listed in the table, use the formula anyway. Your answer will be close enough to the actual screen size to let you know what size receiver you're buying.

IC'S IN RECEIVERS

The integrated circuit has begun to replace the ordinary transistor-plus-components package in home-entertainment receivers. Sony Corp. claims to have the "world's smallest radio," which uses an IC containing 9 transis-

continued on page 12

Radio-Electronics

154 WEST 14TH STREET
NEW YORK 10011

HUGO GERNSBACK, editor-in-chief
M. HARVEY GERNSBACK, publisher
FOREST H. BELT, editor
Bruce Ward, production manager
Robert F. Scott, W2PWC, technical editor
Thomas R. Haskett, associate editor
Jack Darr, service editor
I. Queen, editorial associate
Allen B. Smith, science editor
Peter E. Suthem, audio editor
Wm. Lyon McLaughlin, technical illustration director
Nancy Gitchel, editorial assistant
Adelaide Cassidy, production assistant
G. Aliquo, circulation manager
Joseph L. Bund, newsstand director

Cover by Harry Schlack

RADIO-ELECTRONICS is published by Gernsback Publications, Inc.
Chairman of the Board: Hugo Gernsback
President: M. Harvey Gernsback
Vice President-Secretary: G. Aliquo

ADVERTISING REPRESENTATIVES EAST

John J. Lamson,
RADIO-ELECTRONICS, 154 West 14th Street,
New York 10011, 212-255-7755

MIDWEST

Robert Pattis, the Bill Pattis Co., 4761 West Touhy Ave., Lincolnwood, Ill. 60646, 312-679-1100

W. COAST/TEXAS/ARKANSAS/OKLAHOMA

J. E. Publishers Representative Co., 8380 Melrose Ave., Los Angeles, Calif. 90069, 213-653-5841; 420 Market St., San Francisco, Calif. 94111, 415-981-4527

UNITED KINGDOM

Publishing & Distributing Co., Ltd., Mitre House, 177 Regent St., London W.1, England

SUBSCRIPTION SERVICE: Send all subscription correspondence and orders to RADIO-ELECTRONICS, Subscription Department, Boulder, Colo. 80302. For change of address, allow six weeks, furnishing both the old and new addresses and if possible enclosing label from a recent issue.

MOVING? Or writing about subscription? Be sure to fill out form below.

For FASTEST service on address change, missing copies, etc., attach old mailing label in first space below. Otherwise please print clearly your address as we now have it.

OLD ADDRESS (Attach old label if available)

Name

Address

City State

Zip Code

NEW ADDRESS

Name

Address

City State

Zip Code

Mail to: **RADIO-ELECTRONICS**
Subscription Dept. Boulder, Colo. 80302

This E-V driver has a hole in the back

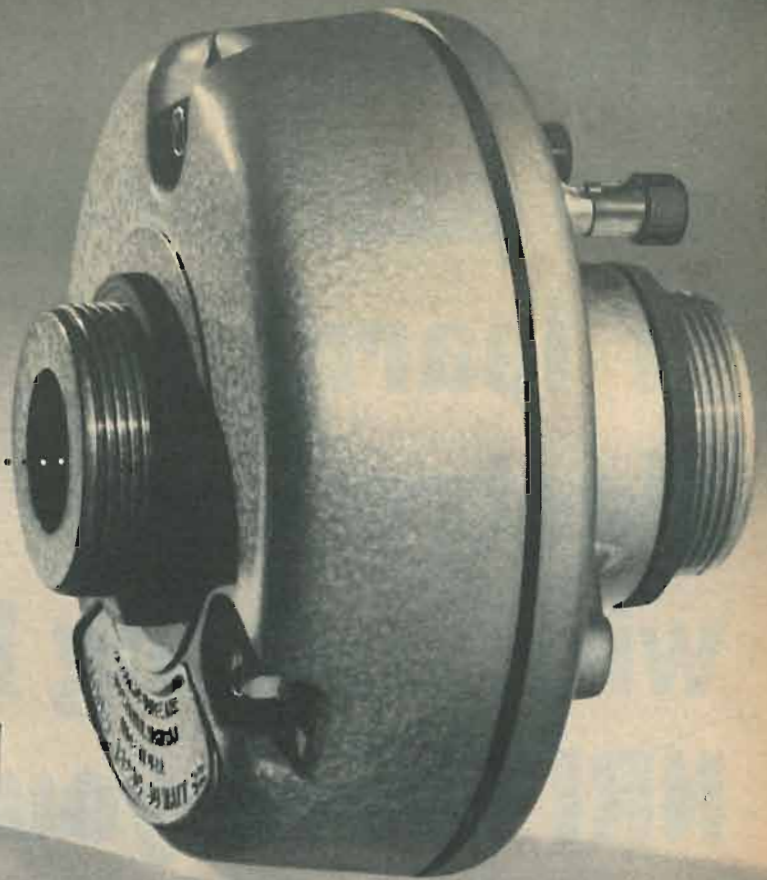

It's one of the ways Electro-Voice takes the holes out of P.A. system response!

(E-V) Too often, ragged frequency response starts at the P.A. driver. And all too often, there's a big hole in response from about 2 to 7kHz. But that's right where you need solid response for top-notch intelligibility. So E-V did something about it.

With these new P.A. drivers, E-V insured smooth, commanding high frequency response. How? By reducing the strength of the diaphragm and voice coil. Special attention was also paid to internal sound paths — attention that paid off with unusually uniform response—and significantly improved articulation.



MODEL 1828R

There are three versions of these new 30-watt drivers. The Model 1828R fits any reentrant or other conventional

horn. When coupled to an E-V Model AR150, FR150 or HC400 reentrant horn, the wide-range performance belies the modest cost.

The Model 1828C — also rated at 30 watts — is a compound driver. It has a hole in the back. While it can be used on reentrant horns, it is specially designed to operate in exclusive E-V compound horns. The idea is simple: a big horn for lows hooked to the back of the 1828C, and a small horn for highs attached to the front. It means wider range and dramatically lower distortion. You can choose the famous CDP® (FC100) wide angle horn, or the fantastic new AC100 concentrating version.



MODEL 1828C

The third model — the 1828T — also

fits either reentrant or compound horns. In addition it has an efficient 70.7-volt line transformer built in. A transparent panel lets you see what tap has been selected, and you can change taps at any time — without disturbing the primary wiring.

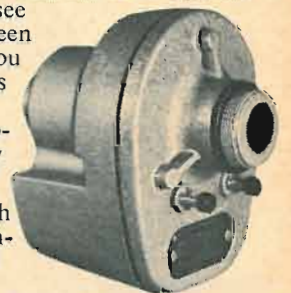

MODEL 1828T

There's much more to recommend the 1828 Series of P.A. drivers. Die-cast housings, spring-loaded terminals, improved weatherproofing and the highest production standards in the industry. Try these new E-V P.A. drivers today. They're designed to keep you out of a hole!

ELECTRO-VOICE, INC., Dept. 276E
613 Cecil Street, Buchanan, Michigan 49107

microphones • public address loudspeakers • high fidelity components
phonograph needles and cartridges • organs • space and defense electronics

Circle 11 on reader's service card

Electro-Voice®
SETTING NEW STANDARDS IN SOUND

Discover the excitement of learning Electronics with training kits NRI sends you

New Achievement Kit Custom Training Kits "Bite Size" Texts

Only NRI offers you this pioneering method of "3-Dimensional" home-study training. It's the result of more than half a century of simplifying, organizing, dramatizing subject matter. As an ambitious man you can effectively learn the Electronics field of your choice the NRI way. But NRI training is more than kits and texts. It's personal services, too, which have made NRI a 50-year leader in the home-study field.

YOU GET MORE FOR YOUR MONEY FROM NRI

Everything that you see here is included in just one NRI course. Other courses are equally complete, yet you'll be surprised at the low cost. Text for text, kit for kit, dollar for dollar—your best home study buy is NRI.

Available Under **NEW GI BILL**

If you served since January 31, 1955, or are in service, check GI line in postage-free card.



*Earn \$4 to \$6 an hour
spare or full time in*
**TV-RADIO
SERVICING**

Want to earn extra money? Looking for a good paying job? Interested in your own full-time business? Radio-TV Servicing is the branch of Electronics offering all these opportunities. In addition to teaching you the facts, NRI shows you how to earn while you learn.

You can learn quickly how to install, maintain and service tube and transistor home and auto radios, TV sets (including booming Color TV), hi-fi and stereo, public address systems. Like thousands of others, you can be earning \$4 to \$6 an hour in spare-time starting soon after you enroll.

*There's glamor and
success awaiting you in*
**BROADCASTING—
COMMUNICATIONS**

Good paying, fascinating positions await competent Communications Operators and Technicians. Broadcast stations, commercial stations, ships, aircraft, land vehicles all need men who know how to maintain and repair transmitting and receiving equipment. With closed-circuit TV, Facsimile, Microwave, Radar, Telemetry and all the communications needs of the Space Age, you can see how important training in this field has become. NRI training includes preparation for your First Class Radiotelephone FCC License. *And you must pass the FCC exam or NRI refunds your tuition in full!*

*Move ahead in America's
fast moving industry as an*
**ELECTRONICS
TECHNICIAN**

There is a serious shortage of qualified Electronics Technicians. Electronics has found its way into hundreds of areas not even dreamed of ten years ago: offices; manufacturing; medical and dental uses; transportation; space exploration; government and military equipment . . . there's no end of opportunity for trained men. This course stresses the basic principles around which most Electronic devices are built; prepares you for many current job openings. Prepare now. Learn Automation, computers, data processing, ultrasonics, telemetry. Whatever your interest in Electronics, you'll find an NRI training plan for you. Check the course of most interest to you on the postage-free card and mail it today for your free NRI Catalog. No obligation. No salesman will call. NATIONAL RADIO INSTITUTE, Washington, D. C. 20016.



**More than
50 years of leadership
in Electronics Training**

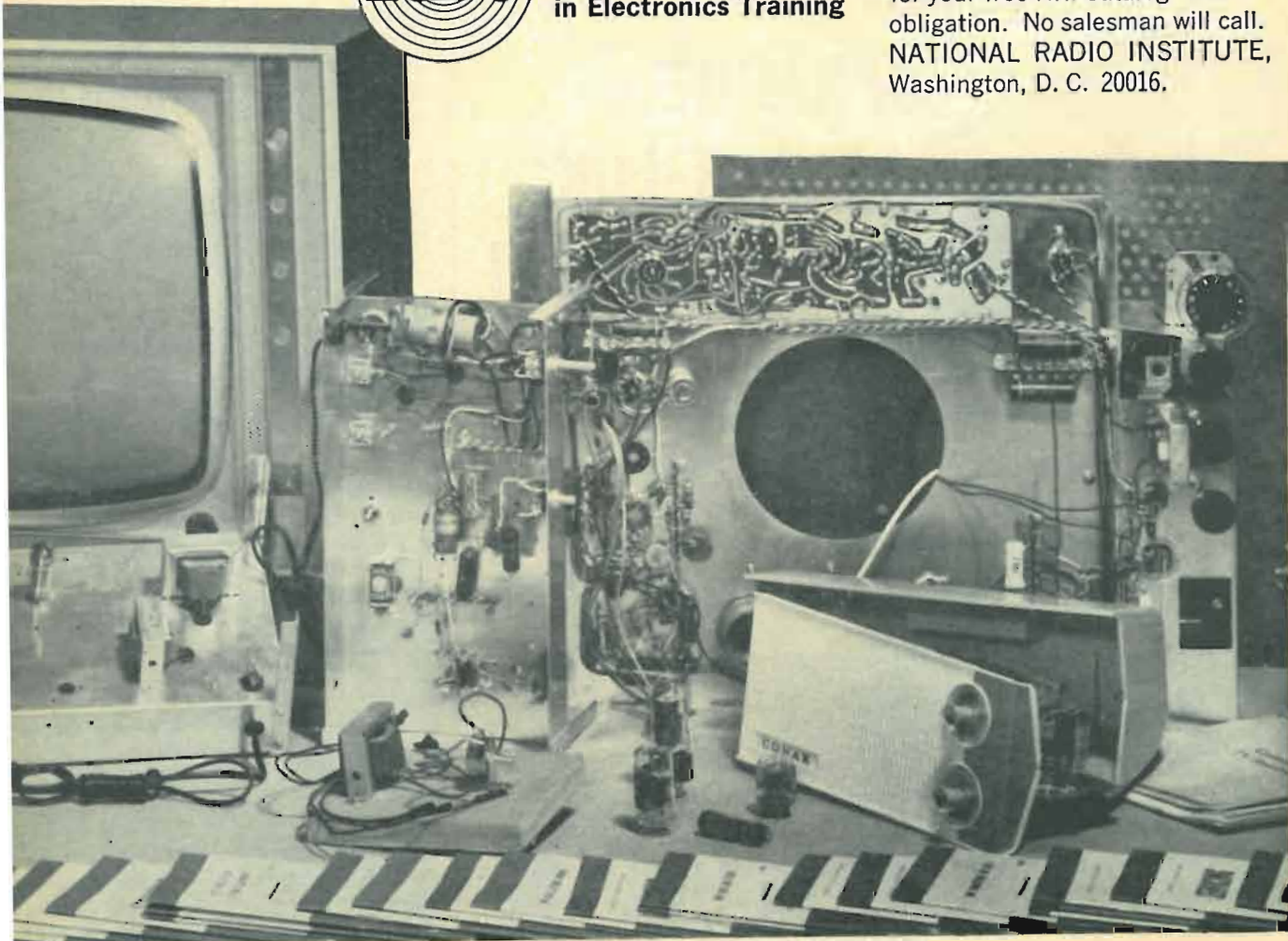

WHY bother with makeshift twist-prong capacitor replacements?

When you substitute capacitor sizes and ratings, you leave yourself wide open for criticism of your work . . . you risk your reputation . . . you stand to lose customers. It just doesn't pay to use makeshifts when it's so easy to get the exact replacement from your Sprague distributor!

Get the right SIZE,
right RATING every time
with improved



**SPRAGUE
TWIST-LOK®
CAPACITORS!**

1,863 different capacitors to choose from!

The industry's most complete selection of twist-prong capacitors, bar none. Greater reliability, too. Exclusive Sprague cover design provides a leak-proof seal which permits capacitors to withstand higher ripple currents.

GET YOUR COPY of Sprague's comprehensive Electrolytic Capacitor Replacement Manual K-108 from your Sprague Distributor, or write Sprague Products Co., 81 Marshall Street, North Adams, Mass.



WORLD'S LARGEST MANUFACTURER OF CAPACITORS

Circle 12 on reader's service card

NEWS BRIEFS continued

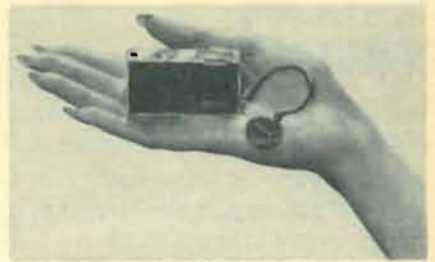

tors, 4 diodes, and 14 integrated resistors. All these components are contained in a silicon pellet smaller than the head of a pencil. The radio—model ICR-100—weighs less than 3 oz, and measures $2\frac{1}{4} \times 1\frac{1}{4} \times \frac{3}{4}$ inches. It uses a special oval speaker, nickel-cadmium batteries, and contains a built-in battery charger. The receiver was initially available in limited quantities just before Christmas only in New York City, but will be marketed this year throughout the US.

An all-IC portable phonograph will be sold by Westinghouse during 1967. General Electric also has plans to market an IC phonograph.

Integrated circuits have been used in TV sound sections by RCA since March 1966. Now Packard Bell is adopting the practice in their 1967 black-and-white models. The Panasonic equipment line (made by Matsushita) includes two radios and a 12-inch TV using IC's.

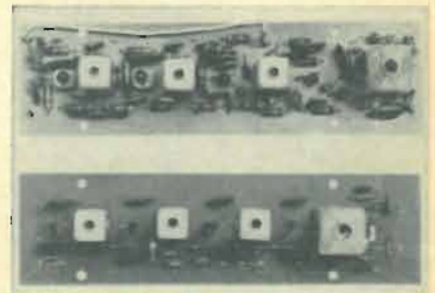

The tiny devices are even finding their way into stereo hi-fi equipment. H. H. Scott is producing three stereo FM receivers with IC's in the i.f. strip (see photo). Fisher Radio Corp. plans to bring out an AM-FM receiver using integrated circuits.

Motorola employs IC's in an FM transceiver they make for the Army.

For more detailed information on integrated circuits, be sure to see the March 1967 special issue of RADIO-ELECTRONICS.

MORE ON LASERS

High-voltage and high-power circuits may now be switched more easily with a technique developed by West-

inghouse Research Laboratories. A gallium-arsenide laser, radiating coherent infrared light, triggers a LASS (Light-Activated Silicon Switch). The photo shows one of the new switches. At the left is the light-guiding tube; in the center, the encapsulated switch; on the right is the working silicon wafer.

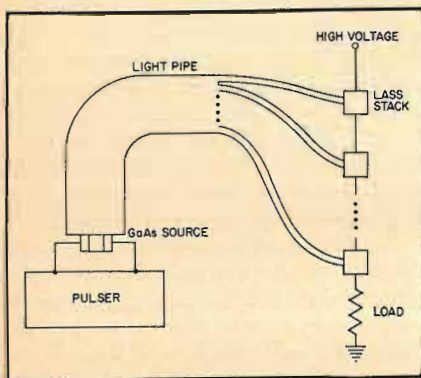
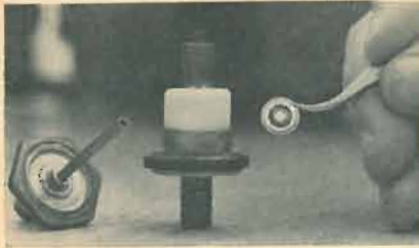

While the LASS is similar to a thyristor or SCR, it has certain advantages. The switching circuit is completely isolated from the load on the LASS, since light activation is used. Also, a series of LASS's in a stack may all be switched simultaneously by piping the laser beam to each.



A laser beam has also been used to record a holographic picture—a true three-dimensional image—without a lens. The photo shows Dr. Ronald Lundgren of Hughes Aircraft Co. making a recording of small figurines. END



At 300 rpm all you can hear is the music.

Most turntables utilize motors that operate at 1800 rpm. The new Sony Servo-Controlled TTS-3000 employs a motor that provides optimum torque at 300 rpm. The absence of rumble-producing vibration intruding

employs the first precision servo-controlled tonearm, no noise, precise speed, beautiful music (see extra).

The Sony VC-8E moving coil cartridge, \$65.95. Prices, suggested list. At your Sony high fidelity dealer, Dept. H, 47-47 Van Dam Street, New York, N.Y.

Reader's service card

PETITORS

designs in so much value

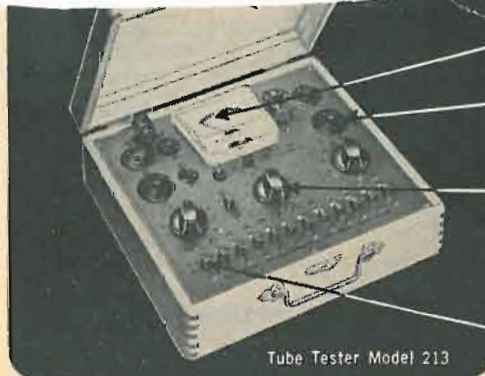

Tube Tester Model 213

Compact, lightweight portability. Use it on the bench or in the field.

Full-view meter gives direct, clear-cut quality indications.

Full complement of sturdy sockets accepts compactron (12-pin), nuvistor, novar, 10-pin, 9-pin, octal, octal, and miniature tubes.

Three heavy-duty controls for quick set-up of all tests. Check a fistful of tubes in the time it often takes to test one.

Precise programming. Only one socket per tube-base configuration prevents accidental plug-in.

12 slide switches for individual selection of tube pins provides versatility in testing, prevents obsolescence.

THE MODEL 213 saves you time, energy, money ■ Checks for shorts, leakage, intermittents, and quality ■ Tests all tube types including magic eye, regulator, and hi-fi tubes ■ Checks each section of multi-purpose tubes separately ■ Gives long, trouble-free life through heavy-duty components, including permanently etched panel ■ Keeps you up to date with FREE, periodic listings on new tubes as they come out ■ Your best dollar value in a tube tester. Available in high-impact bakelite case with strap: \$28.90 wired; \$18.90 in kit form. Wood carrying case (illustrated) slightly higher.



ELECTRONIC MEASUREMENTS CORPORATION
625 Broadway, New York 12, New York
Export: Pan-Mar Corp., 1270 B'way, N. Y. 1, N. Y.

EMC, 625 Broadway, New York 12, N. Y.
Rush me FREE catalog describing all EMC value-loaded test instruments and name of local distributor.

NAME _____
ADDRESS _____
CITY _____ ZONE _____ STATE _____

RE-2

look to Xcelite for the best in pliers & snips, too



LONG NOSE
AND
DIAGONAL PLIERS



CHAIN NOSE
ELECTRICIAN'S PLIERS



COMBINATION
SLIP JOINT PLIERS



NEEDLE NOSE PLIERS



RADIO AND TV PLIERS



SIDE CUTTING PLIERS



TRANSVERSE CUTTING PLIERS



UTILITY PLIERS



ELECTRONIC SNIPS

Same professional quality as famous Xcelite screwdrivers and nutdrivers. Forged alloy steel construction. Precision machined. Scientifically proportioned. Variety of sizes. All available with permanent, plastic coated Cushion Grip handles for extra working comfort (except slip joint models).

WRITE FOR CATALOG SHEET N664

XCELITE

XCELITE, INC., 10 BANK ST., ORCHARD PARK, N. Y.
Canada: Charles W. Pointon, Ltd., Toronto, Ontario

Circle 14 on reader's service card



THE RIGHT HAND KNOWETH NOT . . .

Dear Editor:

In the November 1966 issue, I found a very amusing cartoon on page 51. This witty cartoon shows a TV camera and receiver, which seem to replace most advantageously the mirror of our ancestors. Yet there is in the cartoon an error which would make the use of the system difficult at least.

On the TV screen, the man is seen as in a mirror. He is shaving his right cheek, while his image shaves the left! That's wrong. A television system does not cause the right-left inversion produced by a mirror (except by inverting the horizontal sweep).

E. AISBERG

Paris, France

MORE ON FOREIGN AID

Dear Editor:

On page 15 of your November 1966 issue I noticed a letter from J. P. Saxena of Kathmandu, Nepal, who complains of American manufacturers not replying to letters, sending catalogs, etc. I can think of many reasons for his not getting replies from American manufacturers. They may not be familiar with the foreign postal regulations, or they may not have export facilities or proper arrangements to ship to foreign

countries. Patent or other regulations limit the areas where they can sell their products.

If you will check with the US Dept. of Commerce office nearest you, you may find that Nepalese import regulations and high tariffs may make it nearly impossible for a person there to purchase parts from the US. Also, our prices, when paid for in their limited-value currency, might make parts that are simple and cheap to us prohibitively expensive there. Perhaps manufacturers just don't know how to handle his requests.

MERRITT L. PERKINS

Three Rivers, Mich.

Dear Editor:

In reading "Correspondence" in the November 1966 issue, I have this to add about "Foreign Aid." Out of 20 manufacturers I have written concerning their products, only about 3 or 4 answer the first inquiry. The others wait for from 3 to 5 letters, if they answer at all. One in particular I wanted an answer from and sent a certified letter over a year ago. Never did receive an answer.

If this office snobbery is current to people in the States, I can understand the foreign trouble. I am sure (the manufacturers') views are "%%!*" with the one-item purchaser."

LEO E. SMITH

Sandy, Utah

TAPES BY MAIL

Dear Editor:

The letter in Jack Darr's "Service Clinic" column of November 1966 regarding erasing of tapes sent overseas was of special interest to me. His reply was correct, but there was one factor left out. All outgoing packages passing through customs offices either here or overseas are passed under an X-ray machine. You know what would happen to a sound tape going under such radiation—complete erasure. Postal authorities stress that any shipments of sound or data recordings made magnetically on tape be clearly marked:

SOUND TAPE RECORDING
DO NOT X-RAY

This is true as well of the tapes coming back into the US from abroad.

L. NORMAN GRAY

Indianapolis, Ind.

ENGINEERS AND TECHNICIANS

Dear Editor:

As a retired EE, I have filled in a few spare moments checking the TV sets and radios of my close relatives. Most have had repairs by TV servicemen, resulting in varying degrees of performance. None were entirely satisfactory, which was the reason I was prevailed

This **Remington** PREMIER PORTABLE TYPEWRITER

FREE



**WHEN YOU BUY THIS RCA WR-64B
COLOR BAR/DOT/CROSSHATCH
GENERATOR...THE ESSENTIAL
COLOR TV TEST INSTRUMENT**

Here's a deal you can't afford to miss! A FREE Remington portable typewriter—yours when you purchase the most essential color-TV test instrument—the RCA WR-64B!

Just imagine how handy your new typewriter will be—in the shop or at home. You'll use it almost as much as you use the RCA WR-64B—standard of the color TV servicing industry.

Here's how to get your FREE Remington Typewriter. Mail in the warranty card plus the gold label from the shipping carton of your new RCA color bar generator to RCA Test Equipment Headquarters, Bldg. 17-2, Harrison, N.J. We will ship your new Remington portable typewriter to you direct, freight prepaid. But remember—this offer covers only equipment purchased between February 1, 1967 and May 15th, 1967. To allow for postal delay, we will honor cards postmarked up to May 31st.

Plan NOW to take advantage of this BIG offer—a FREE Remington portable typewriter with your purchase of an RCA WR-64B color bar/dot/crosshatch generator.



The standard of the Color-TV Servicing Industry. Generates all necessary test patterns—color bars, crosshatch, dots plus sound-carrier. Only \$189.50*

*Optional Distributor resale price. All prices subject to change without notice. Price may be slightly higher in Alaska, Hawaii, and the West.

Ask to see it at Your Authorized
RCA Test Equipment Distributor

RCA Electronic Components and Devices, Harrison, N.J.



The Most Trusted Name in Electronics

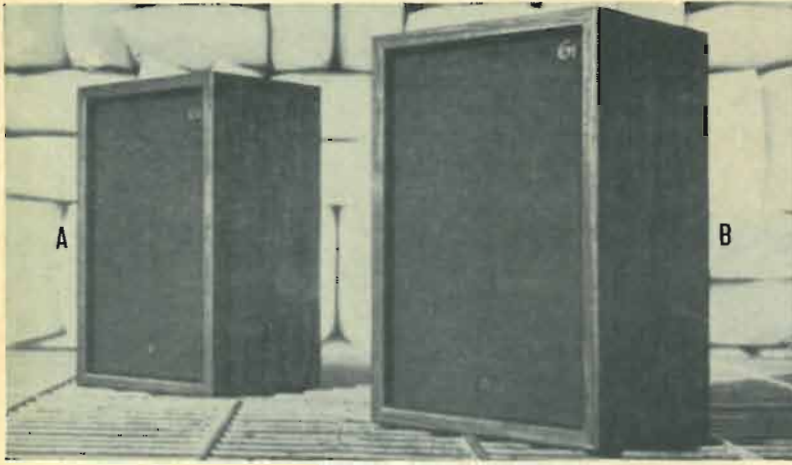

When a Pioneer Speaks ...it's time to listen!

That's when you'll hear the optimum in tonal quality . . . sound reproduction at its faithful best.

You can always count on Pioneer speakers and speaker systems to deliver a quality performance. Every time. All the time.

Made by the world's largest manufacturer of speakers, this premium audio equipment available at popular prices. And you can select from many fine models — from the unique, handsome metal-grilled CS-24 Auxiliary Wall

Speaker to the efficient, compact CS-20, CS-52 and the Ultimate 5-speaker CS-61 Bookshelf System. All carried only by franchised dealers.

A word from you and we'll send literature and the name of your nearest dealer.

(A) CS-62 Bookshelf 3-way speaker system (3 speakers). Oiled walnut enclosure. Meas. 25 $\frac{1}{2}$ " x 15 $\frac{3}{8}$ " x 11 $\frac{1}{16}$ ", retail price: \$142.00.
(B) CS-61 Bookshelf 3-way speaker system (5 speakers). Oiled walnut enclosure. Meas. 24 $\frac{1}{4}$ " x 16 $\frac{1}{8}$ " x 13 $\frac{1}{4}$ ", retail price: \$175.00.



PIONEER ELECTRONICS U.S.A. CORPORATION

140 SMITH AVE. FARMINGDALE, LONG ISLAND, N.Y. 11735 • (516) 694-7720

Circle 16 on reader's service card

ACHIEVEMENT
'67
IN
ELECTRICAL/
ELECTRONICS
ENGINEERING

EXHIBITS
NEW YORK
COLISEUM

**TECHNICAL
SESSIONS**
NEW YORK HILTON

Monday through Thursday
MARCH 20-23 1967

- 69 Technical Sessions at the New York Hilton. Hours: Mon. 9:30-12:00 a.m.; 2:00-4:30 p.m. — other days 9:00-11:30 a.m.; 2:00-4:30 p.m.

- **FOUR COMPLETE FLOORS OF EXHIBITS** at the New York Coliseum including over 700 firms. Hours: 10 a.m.-8 p.m. 4 Days.

- Gala Annual Banquet — Wednesday 7:15 p.m. New York Hilton Grand Ballroom — \$15.00

- Free shuttle busses between the Hilton and the Coliseum — every few minutes.

- Registration — IEEE Members \$2.00 Non-members \$5.00 Ladies \$1.00 High School Students \$2.00 if accompanied by an adult. One student per adult Monday through Wednesday, Thursday only — limit of 3 students per adult. Good for all days — Technical Sessions and exhibits. In and out privileges.



'67 International
IEEE CONVENTION / EXHIBITION

CORRESPONDENCE continued

upon to examine them.

My examination showed a lack of knowledge in the art of soldering. Great gobs of solder on joints, with splashes of solder on other components, left there with no regard for possible future troubles. Substitute parts, including tubes, were not always equivalent or direct replacement types. It seems that many parts were "hung on" in the hope that the picture would be restored to normal with no regard for exactness.

I would also add my voice to the many who have made objections to the lack of foresight on the part of manufacturers regarding "serviceability." Repair costs are aggravated by inaccessibility. In addition, proper ventilation is seldom considered in the design of TV chassis—at least, not to any great extent that I have seen.

Let's plead for practice on the part of repairmen so that repairs which depend upon solder connections will be well done.

B. P. SCHROEDER

La Puente, Calif.

TO HELP RELIEVE TECHNICAL SHORTAGE

Dear Editor:

The University of Illinois will introduce an entirely new course of instruction and training in microprecision technology on February 1. This course will be offered tuition-free to 60 young people across the nation who can qualify.

The demand for people with microprecision knowledge and skills is great and placement opportunities of the program are unusual; many challenging offers for rewarding careers will be open to graduates.

The course will furnish experience in electronics, instrumentation, machine work, precision production of electronic circuits and mechanical elements, mechanical systems, and applied economics, among others.

To apply for this unusual tuition-free training, students must be graduates of an approved high school or have equivalent credentials, be 18 to 25 years of age, in good health, and have completed high school work in algebra.

HUGH G. WALES

P.O. Box 2070
Station A
Champaign, Ill. 61820

PEN PAL

Dear Editor:

I would like to exchange mail with technicians from the United States and all over the world. Would you put my address in your magazine?

MANUEL PACHECO P.

Tajin 219-13
Mexico 12 D. F.

END

POWER **NEW** POWER

FROM

FINCO

Model 65-3 VHF-TV ANTENNA AMPLIFIER

improves reception of WEAK VHF-TV signals in FRINGE AREAS even where strong local TV or FM signals are present. AMPLIFIES UP TO 7 TIMES for Better Color and B/W

A two-transistor—high and low band—amplifier in one compact weather-resistant housing. Engineered to provide the lowest noise and highest amplification with the most desirable overload characteristics. Designed for easy and convenient installation on antenna boom, mast, or under roof eave.

Amplifier used in conjunction with dual outlet power supply for one, two, or multiple set installations (with Finco 3003 coupler). 117 V 60 cycle input. AC power up to amplifier: 24 volts - 60 cycle. Metal enclosed with easy keyhole mounting. Amplifier and power supply provided complete with mounting hardware. Each unit tested and inspected prior to shipment.

Let Finco solve your Color and B & W reception problems. Write for complete information, schematics and specifications. Form #20-357.

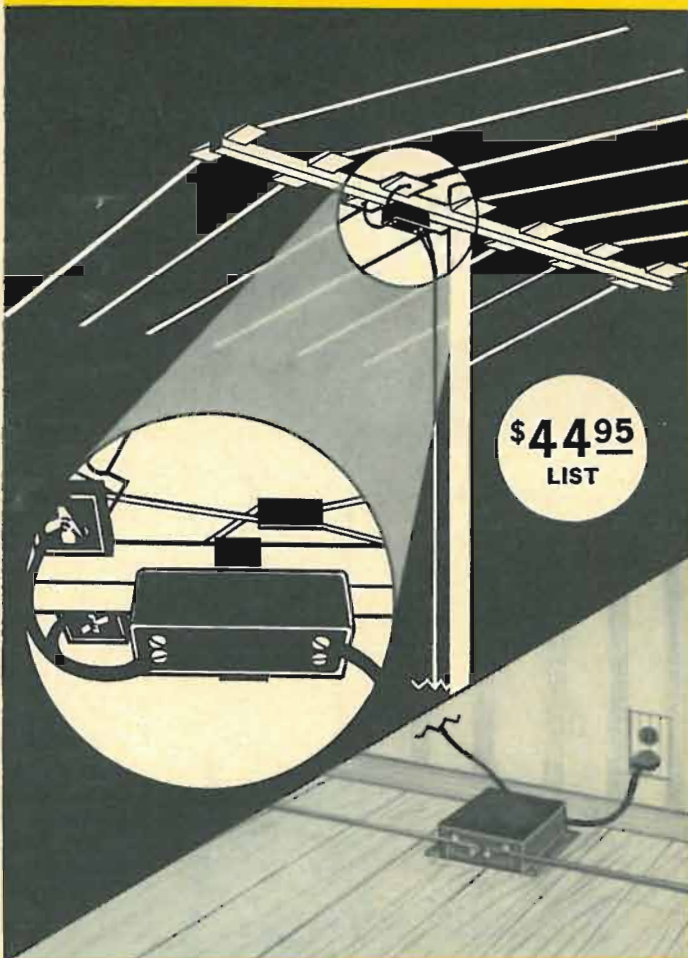

Model 65-3 VHF-TV ANTENNA AMPLIFIER



THE FINNEY COMPANY

34 West Interstate Street • Bedford, Ohio 44014 • Dept. RE

SOMEONE SHOULD DEVELOP AN EASY WAY TO LEARN ELECTRONICS AT HOME

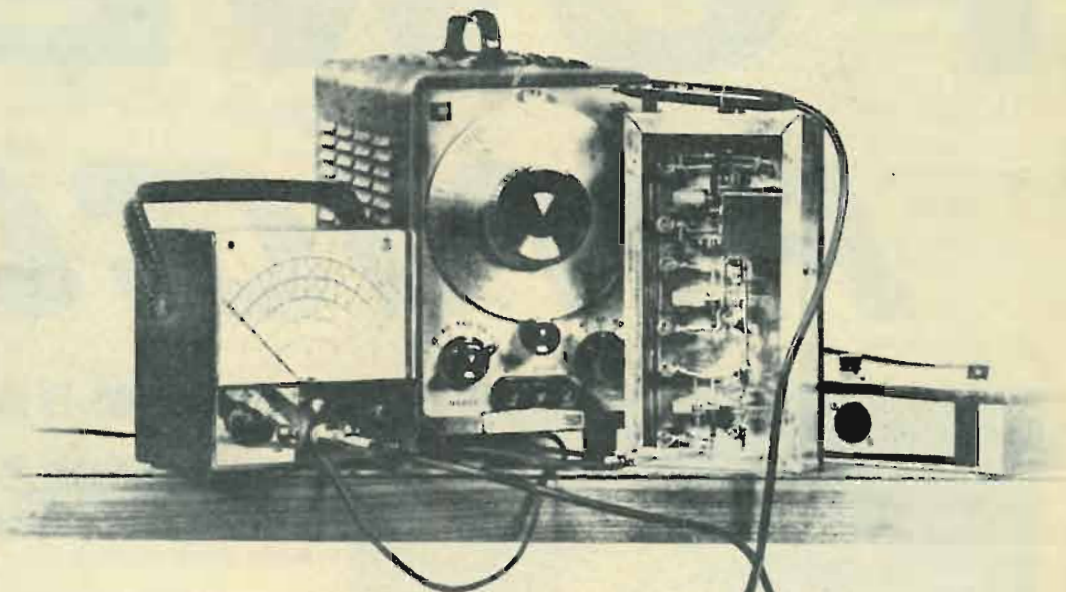

RCA INSTITUTES DID!

Here is a whole new approach to learning electronics at home! RCA Institutes, one of the nations' largest schools devoted to electronics, has developed a faster, easier way for you to gain the skills and the knowledge you need for the career of your choice. Here for the first time, is a student-proved, scientifically designed way to learn. If you have had any doubts in the past about home training in electronics —if you have hesitated because you thought you might not be able to keep up—or that electronics was too complicated to learn—here is your answer! Read how RCA Institutes has revolutionized its entire home training ideas!

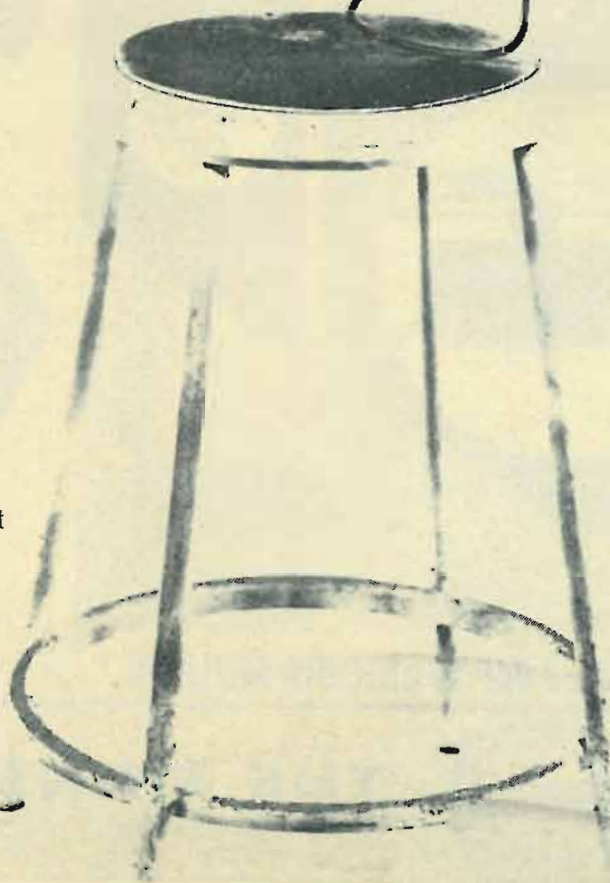

NEW CAREER PROGRAMS

BEGIN WITH "AUTOTEXT" INSTRUCTION METHOD!

Start to learn the field of your choice immediately!

No previous training or experience in electronics needed!

With this new revolutionized method of home training you pick the career of your choice—and RCA Institutes trains you for it. RCA's Career Programs assure you that everything you learn will help you go directly to the field that you have chosen! No wasted time learning things you'll never use on the job! The Career Program you choose is especially designed to get you into that career in the fastest, easiest possible way!

And each Career Program starts with the amazing "AUTOTEXT" Programmed Instruction Method—the new, faster way to learn that's almost automatic! "AUTOTEXT" helps even those who have had trouble with conventional home training methods in the past. This is the "Space Age" way to learn everything you need to know with the least amount of time and effort.

CHOOSE A CAREER PROGRAM NOW

Your next stop may be the job of your choice. Each one of these RCA Institutes Career Programs is a complete unit. It contains the know-how you need to step into a profitable career. Here are the names of the programs and the kinds of jobs they train you for. Which one is for you?

Television Servicing. Prepares you for a career as a TV Technician/Serviceman; Master Antenna Systems Technician; TV Laboratory Technician; Educational TV Technician.

FCC License Preparation. For those who want to become TV Station Engineers, Communications Laboratory Technicians, or Field Engineers.

Automation Electronics. Gets you ready to be an Automation Electronics Technician; Manufacturer's Representative; Industrial Electronics Technician.

Automatic Controls. Prepares you to be an Automatic Controls Electronics Technician; Industrial Laboratory Technician; Maintenance Technician; Field Engineer.

Digital Techniques. For a career as a Digital Techniques Electronics Technician; Industrial Electronics Technician; Industrial Laboratory Technician.

Telecommunications. For a job as TV Station Engineer, Mobile Communications Technician, Marine Radio Technician.

Industrial Electronics. For jobs as Industrial Electronics Technicians; Field Engineers; Maintenance Technicians; Industrial Laboratory Technicians.

Nuclear Instrumentation. For those who want careers as Nuclear Instrumentation Electronics Technicians; Industrial Laboratory Technicians; Industrial Electronics Technicians.

Solid State Electronics. Become a specialist in the Semiconductor Field.

Electronics Drafting. Junior Draftsman, Junior Technical Illustrator; Parts Inspector; Design Draftsman Trainee Chartist.

SEPARATE COURSES

In addition, in order to meet specific needs, RCA Institutes offers a wide variety of separate courses which may be taken independently of the Career Programs, on all subjects from Electronics Fundamentals to Computer Programming. Complete information will be sent with your other materials.

LIBERAL TUITION PLAN

RCA offers you a unique Liberal Tuition Plan—your most economical way to learn. You pay for lessons only as you order them. No long term contracts. If you wish to stop your training for any reason, you may do so and not owe one cent until you resume the course.

VALUABLE EQUIPMENT

You receive valuable equipment to keep and use on the job—and you never have to take apart one piece to build another. **New—Programmed Electronics Breadboard.** You now will receive a scientifically programmed electronic bread-

board with your study material. This breadboard provides limitless experimentation with basic electrical and electronic circuits involving vacuum tubes and transistors and includes the construction of a working signal generator and superheterodyne AM Receiver.

Bonus From RCA—Multimeter and Oscilloscope Kits. At no additional cost, you will receive with every RCA Institutes Career Program the instruments and kit material you need to build a multimeter and oscilloscope. The inclusion of both these kits is an RCA extra.

CLASSROOM TRAINING ALSO AVAILABLE

RCA Institutes maintains one of the largest schools of its kind in New York City where classroom and laboratory training is available in day or evening sessions. You may be admitted without any previous technical training; preparatory courses are available if you haven't completed high school. Coeducational classes start four times a year.

FREE PLACEMENT SERVICE

In recent years, 9 out of 10 Resident School students who used the Free Placement Service had their jobs waiting for them when they graduated. And many of these jobs were with top companies in the field—such as IBM, Bell Telephone Labs, General Electric, RCA, and radio and TV stations and other communications systems throughout the world.

SEND ATTACHED POSTAGE PAID CARD FOR COMPLETE INFORMATION, NO OBLIGATION. NO SALESMAN WILL CALL. FREE BOOK INCLUDED. CHECK HOME STUDY OR CLASSROOM TRAINING.

RCA INSTITUTES, Inc., Dept. RE-27

A Service of Radio Corporation of America
350 West 4th St., New York, N.Y. 10014



The Most Trusted Name in Electronics

NOW

FROM



A Complete Automotive and Ignition Tune-Up System



MARK TEN

Capacitive Discharge Ignition System

\$44⁹⁵ Assembled

\$29⁹⁵ Kit Form

Get mileage you never dreamed of! 3 to 10 times spark plug life. Instant starts in all weather. Installs in only 10 minutes. Up to 20% gas savings. Dramatic increase in engine performance and acceleration.

2 NEW AUTO TUNE UP INSTRUMENTS



DWELL
METER
\$12.95
Ppd.



TACH
METER
\$14.95
Ppd.

These two new cousins to the world famous proven MARK TEN now give you the capability to tune your own car inexpensively, easily, with remarkable precision. These separate instruments are low cost, portable and the easiest to read you've ever seen.

- Delta's famous printed circuit design
- Superior in precision, quality and performance to instruments selling for FIVE TIMES as much
- Large dial, high quality jewel D'Arsonval meters
- Operates with standard, transistor or capacitive discharge systems as well as magnetos
- Instant readings — no confusing scales

Send Your Order Today



DELTA PRODUCTS, INC.

P.O. Box 1147 RE • Grand Junction, Colo.

Enclosed is \$_____ Ship prepaid.

Ship C.O.D.

Please send:

Dwell Meters @ \$12.95

Tach Meters @ \$14.95

Mark Tens (Assembled) @ \$44.95

Mark Tens (Delta Kit) @ \$29.95

(12 volt positive or negative ground only)

SPECIFY — Positive Negative

6 or 12 Volt

Car Year _____ Make _____

Name _____

Address _____

City/State _____ Zip _____

DP 6-11

Circle 19 on reader's service card

SERVICE CLINIC

In the Shop... With Jack

By JACK DARR

What Can You Do With A Microammeter?

DARN NEAR ANYTHING. EXAMPLE: YOU can't get along in two-way radio servicing without one, for many transceivers have built-in metering circuits for alignment, transmitter tuneup and loading, etc., using a 0-50 microampere meter. In FM sets, or in any stage which is normally driven into the grid-current region, the grid current of an i.f. amplifier, etc., is directly proportional to the input signal strength (up to the limiting point, of course).

Here's another one: Once in a while, we'd like to read the actual grid voltage of a vhf or hf oscillator. But, if we put a meter across the circuit, even a vtvm may either throw it out of oscillation, or detune it so badly that our reading is meaningless. Beside this, some ac voltmeters aren't 100 accurate up around 50-150 MHz!

So, how can we read the amplitude of oscillation? Open the bottom end of

This column is for your service problems—TV, radio, audio or general and industrial electronics. We answer all questions individually by mail, free of charge, and the more interesting ones will be printed here.

If you're really stuck, write us. We'll do our best to help you. Don't forget to enclose a stamped, self-addressed envelope. Write: Service Editor, Radio-Electronics, 154 West 14th Street, New York 10011.

the grid resistor and insert the microammeter. Now, we can turn the oscillator on, and note the reading in microamps; multiply this by the value of the grid resistor, and we have the peak value of the grid-voltage signal. Since the grid draws current only on positive peaks, this represents peak, not p-p voltage. The absolute accuracy of the reading is determined by the tolerance of the grid resistor. Anyhow, it's a very useful check, when we need to know whether an oscillator is working or not, and delivering a certain amount of signal into the following circuits.

This same test can be used on vhf frequency-multiplier circuits, or in any stage working class B, which means that it is drawing grid current at least part of the time. Class C stages of course will give lower, but still useful readings. In frequency multipliers, meter the grid current of the multiplier stage, while tuning up the plate or output circuit of the oscillator. If it's a multiple-stage multiplier, read the grid current of one stage while tuning the preceding circuit for maximum output on the desired frequency.

Another use—read rf output of very small CB transmitters. Just hook a diode (any kind) either in series or shunt with the microammeter, and add a pickup rod to get some signal. The diode rectifies the rf output of the transmitter, and the resulting dc is read on the meter. You can ground the other side of the meter, although this usually isn't necessary (see Fig. 2). Tune the transmitter for a peak reading on the meter. For best results, keep the pickup rod at least 1/4 wavelength away from the antenna (about 9 feet at 27 MHz).

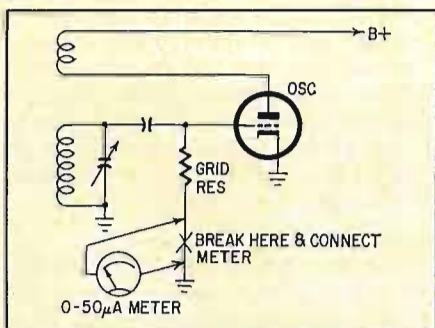

Fig. 1—Reading grid current is one way to measure the oscillator peak voltage.

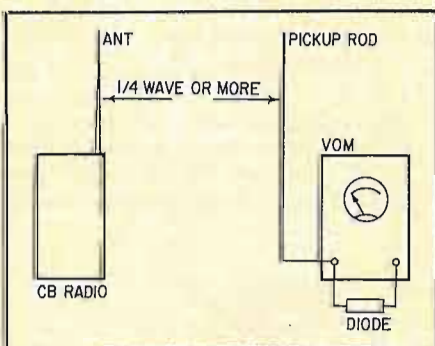

Fig. 2—Read rf output of tiny CB radio by hookup of diode and microammeter.

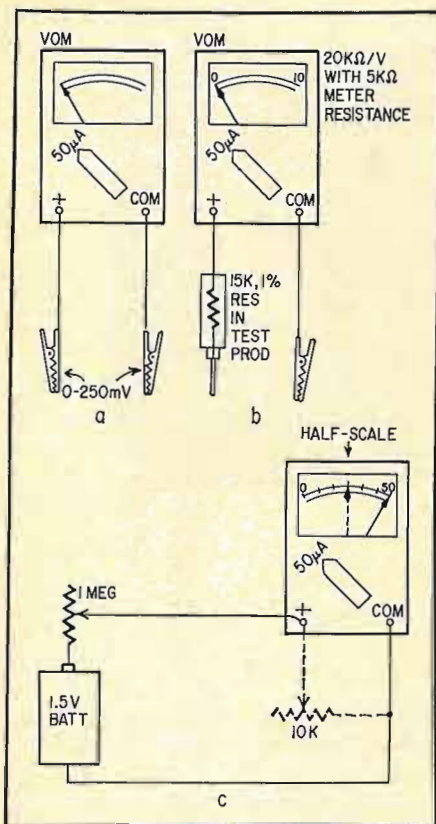

Fig. 3-a—The 0-50- μ A range equals 250 mV "as is." b—Add 15K series multiplier to make 0-1-volt range. c—How to find actual resistance of the 0-50- μ A scale.

If this cuts down the meter reading too much, put a longer wire on the pickup rod. Alternative, seldom necessary: Make up a tuned circuit resonant at carrier frequency; this will build up rf before feeding it to the diode. Helps tune up 100-mW rigs.

Want to read a voltage that's too small to show on your meter? Like a 0.1-volt bias on a transistor? Mr. Ohm says that the voltage across a circuit is directly proportional to the current flow through the resistance. So, a microammeter can be used as a *voltmeter*. (Actually, a millivoltmeter.)

I checked, and practically all of the vom's with 50- μ A scales seem to use a meter resistance of 5K (total). This makes our higher voltage scales come out at 20,000 ohms per volt. So, a 0-50 microammeter, with 5K resistance, would read 250 mV at full-scale. $5,000/20,000 = .25$ volt (see Fig. 3-a).

If you have a low range of say 0-5 volts, or 0-2.5 volts, and you need a still lower one, make your own multiplier probe. (Fig. 3-b). Starting with the 5K meter resistance, simply add enough resistance to make the total give you the full-scale reading needed. The scale markings of the meter will have a lot to do with this.

If your vom has, say, an 0-1 scale, you can make it read 0-1 volt, by adding

15K in series (so that you come out with $5,000 + 15,000 = 20,000 = 1.0$ volt.) If yours happens to have 0-1.2 volt on the lowest range as one popular make does, simply add enough to make it read where you want it to. Make your multiplier up so that the *total* resistance will be the desired full-scale reading in volts, multiplied by the ohms-per-volt rating. For example, if your lowest scale was 12.0 volts, and you wanted 0-1.2 V., the *total* resistance would be $1.2 \times 20,000$ or 24K; subtract 5K for the meter and your multiplier comes out to a value of 19K.

You can install the multiplier resistor inside a standard test prod, and

label it. Then, all you have to do is plug it in, set the selector switch to microamperes, and you're ready to go.

To do this, you need to be sure of the correct meter resistance of your vom or microamps scales. (Some have more than one!) Ordinarily, this will be 5K, but, unless this is so stated in the instruction manual, you can't be certain. Check it.

Get a 1.5-volt battery and an old 1-meg volume control, and a 10K pot. Hook the meter, volume control and battery in series, as in Fig 3-c, and be sure that the volume control is set to *maximum* resistance. In fact, it's a very

continued on page 26

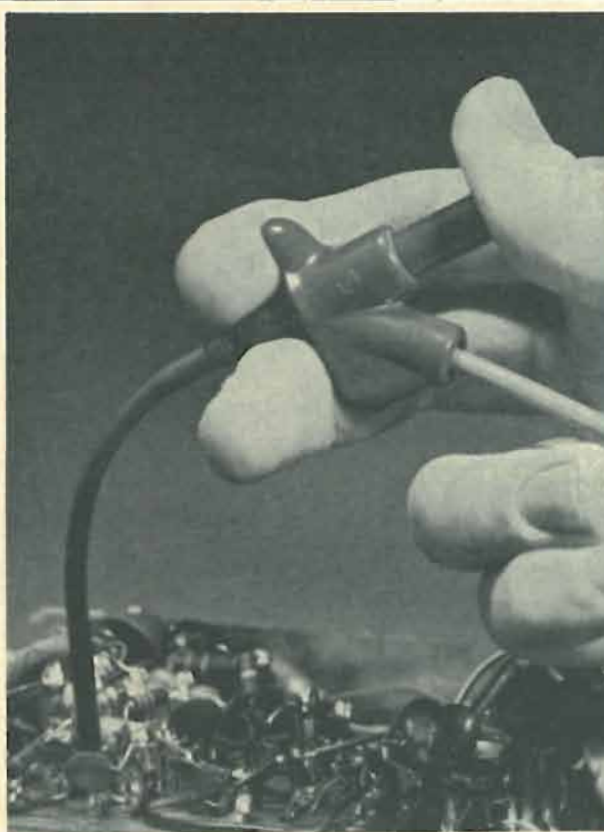

Clever Kleps 30

Push the plunger. A spring-steel forked tongue spreads out. Like this  Hang it onto a wire or terminal, let go the plunger, and Kleps 30 holds tight. Bend it, pull it, let it carry dc, sine waves, pulses to 5,000 volts peak. Not a chance of a short. The other end takes a banana plug or a bare wire test lead. Slip on a bit of shield braid to make a shielded probe. What more could you want in a test probe?

\$1.47



Available through your local distributor, or write:

RYE INDUSTRIES INC.
123 Spencer Place, Mamaroneck, N.Y. 10543

Circle 20 on reader's service card

How To Have Fun While You Save . . .

**Regardless
Of What You Pay
For A Color TV...
It Can't Perform As
Well As This
New Heathkit® "180"
For Only \$379⁹⁵***



Here's Why!

Exclusive Features That Can't Be Bought In Ready-Made Sets At Any Price!

All color TV sets require periodic convergence and color purity adjustments. This new Heathkit GR-180 has exclusive built-in servicing aids so you can perform these adjustments anytime . . . without any special skills or knowledge. Just flip a switch on the built-in dot generator and a dot pattern appears on the screen: Simple-to-follow instructions and detailed color photos in the GR-180 manual show you exactly what to look for, what to do and how to do it.

Results? Beautifully clean and sharp color pictures day in and day out . . . and up to \$200 savings in service calls throughout the life of your set.



Exclusive Heath Magna-Shield!

This unique metal shield surrounds the entire picture tube to help keep out stray external fields and improve color purity. In addition, *Automatic Degaussing* demagnetizes and "cleans" the picture everytime you turn the set on from a "cold" start . . . also permits you to move the set about freely.



Vertical Swing-Out Chassis!

All parts mount on a single one-piece chassis that's hinged

to make it more accessible for easier construction, care and installation.

Your Choice Of Installation!

Another Heathkit exclusive . . . the GR-180 is designed for mounting in a wall or your own custom cabinet. Or you can install it in either of Heath's factory-assembled and finished cabinets.



From Parts To Programs In Just 25 Hours!

. . . and no special skills or knowledge needed. All critical circuits (VHF and UHF tuners, 3-stage IF assembly and high voltage power supply) are prebuilt, aligned and tested at the factory. The GR-180 manual guides you the rest of the way with simple, non-technical instructions and giant pictorials. It's like having a master teacher at your elbow pointing out every step. You can't miss.

Compare These Advanced Performance Features . . . And The Price!

Hi-Fi 180 Sq. Inch Rectangular Tube with anti-glare safety glass, plus "rare earth phosphors", smaller dot size and 24,000 volt picture power for brighter, livelier colors and sharper picture definition.

Automatic Color Control and gated automatic gain control to reduce color fading, and insure steady, jitter-free pictures even under adverse interference such as nearby aircraft traffic.

Deluxe VHF Turret Tuner with "memory" fine tuning so you don't have to readjust everytime you return to a channel.

2-Speed Transistor UHF Tuner for either fast station selection, or fine tuning of individual channels.

Two Hi-Fi Sound Outputs . . . a cathode follower for play through your hi-fi system, plus an 8 ohm output for connection to the GR-180's limited-field 4" x 6" speaker.

Two VHF Antenna Inputs . . . a 300 ohm balanced and a 75 ohm coax to reduce interference in metropolitan or CATV areas.

1-Year Warranty on the picture tube, 90 days on all other parts. In addition, liberal credit terms are available.

***Kit GR-180**, everything except cabinet for custom mounting, 102 lbs. **\$379.95**

Assembled GRA-180-1, walnut cabinet shown above, 30 lbs., 18 1/4" D x 28 1/4" W x 29" H. . . **\$49.95**

Assembled GRA-180-2, Early American cabinet, 37 lbs., 18 1/4" D x 28 1/4" W x 31 1/4" H. . . Available February. **\$75.00**

New 12" Transistor Portable TV — First Kit With Integrated Circuit

Unusually sensitive performance. Plays anywhere . . . runs on household 117 v. AC, any 12 v. battery, or optional rechargeable battery pack (\$39.95). Receives all channels; new integrated sound circuit replaces 39 TV parts; 3-stage IF for maximum gain with controlled bandwidth; gated AGC for steady, jitter-free pictures; instant "on" AC operation; preassembled & aligned tuners for peak performance; transformer operated power supply; front panel mounted speaker; easy 12-hour assembly. Rugged high impact plastic cabinet measures a compact 11 1/2" H x 15 3/4" W x 9 3/8" D. 27 lbs.

Kit GR-104
\$119⁹⁵



Circle 21 on reader's service card

Build Your Own Heathkit® Electronics



**Heathkit "Starmaker"
60-Watt Transistor
Guitar Amplifier**

Kit TA-16
\$129⁹⁵
\$300 Value!

60 watts peak power; two channels — one for accompaniment, organ or mike, the other with tremolo and reverb for lead guitars; two inputs per channel; two 12" heavy-duty speakers; line bypass reversing switch for hum reduction; 13 transistor, 6 diode circuit; 28" W x 9" D x 19" H. Leather-textured black vinyl cabinet of ¾" stock; 120 v. or 240 v. AC operation; extruded aluminum front panel. 52 lbs.

**NEW Transistor Portable
Phonograph Kit**



Kit GD-16
\$39⁹⁵

Worth At Least 50% More! And it sounds better. Assembles in just 1 to 2 hours . . . simply wire one small circuit board, mount the 4" x 6" speaker and plug in the preassembled changer . . . ideal beginner's kit. Features automatic mono play of all 4 speeds; dual Sapphire styli for LP's or 78's; 45 rpm adapter; olive and beige polyethylene over sturdy, preassembled cabinet. Operates on 117 v. AC. 23 lbs.

**5-Band AM /Shortwave Receiver . . .
Deluxe Features For The Seasoned SWL!**

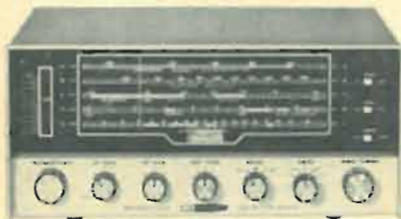

Kit GR-54
\$84⁹⁵

Compare It To Sets Costing \$150 And More! 5 bands cover 200-400 kHz, AM and 2-30 MHz. Tuned RF stage, crystal filter for greater selectivity, separate detectors for AM and SSB, tuning meter, bandspread tuning, code practice provision, automatic noise limiter, automatic volume control, antenna trimmer, built-in 4" x 6" speaker, headphone jack, gray metal cabinet and FREE SWL antenna. 25 lbs.

**Enjoy World-Wide Listening
With This Low-Cost Shortwave Receiver!**



Kit GR-64
\$37⁹⁵

Hear Live Broadcasts From Hundreds Of Foreign Countries, Voice of America, Radio Moscow, hams, ship-to-shore radio, weather and popular AM. Covers 550 kHz to 30 MHz — includes AM plus 3 short-wave bands; 5" speaker; bandspread tuning; signal strength indicator; 7" slide-rule dial; BFO; 4-tube circuit plus 2 rectifiers; noise limiter; external antenna connectors; gray aluminum cabinet, AM antenna. 15 lbs.

**NEW Heathkit® /Magnecord® 1020 4-Track Stereo
Recorder Kit**



Kit AD-16
\$399⁵⁰
(less cabinet)

Save \$170 By Doing The Easy Assembly Yourself. Takes around 25 hours. Features solid-state circuitry; 4-track stereo or mono playback and record at 7½ & 3¾ ips; sound-on-sound, sound-with-sound and echo capabilities; 3 separate motors; solenoid operation; die-cast top-plate, flywheel and capstan shaft housing; all push-button controls; automatic shut-off at end of reel; plus a host of other professional features. 45 lbs. Optional walnut base \$19.95, adapter ring for custom or cabinet installation \$4.75

30-Watt Solid-State FM /FM Stereo Receiver



World's Best Buy In Stereo Receivers. Features 31 transistors, 10 diodes for cool, natural transistor sound; 20 watts RMS, 30 watts IHF music power @ ± 1 db, 15 to 50,000 Hz; wideband FM/FM stereo tuner; plus two pre-amplifiers; front panel stereo headphone jack; compact 3¾" H x 15¼" W x 12" D size. Custom mount it in a wall, or either Heath cabinets (walnut \$9.95, beige metal \$3.95). 16 lbs.

Kit AR-14
\$99⁹⁵
(less cabinet)



FREE!
**World's Largest
Electronic Kit
Catalog!**

Describes these and over 250 kits for stereo /hi-fi, color TV, amateur radio, shortwave, test, CB, marine, educational, home and hobby. Save up to 50% by doing the easy assembly yourself. Mail coupon or write Heath Company, Benton Harbor, Michigan 49022

HEATH COMPANY, Dept. 20-2
Benton Harbor, Michigan 49022
In Canada, Daystrom Ltd.

Enclosed is \$ _____, plus shipping.

Please send model (s) _____

Please send FREE 1967 Heathkit Catalog.

Name _____

Address _____

City _____ State _____ Zip _____

Prices & specifications subject to change without notice.

CL-273

Complete TUNER REPAIR

\$9.50

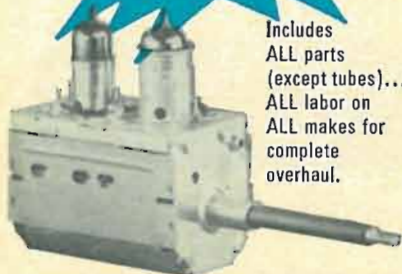

Includes
ALL parts
(except tubes)...
ALL labor on
ALL makes for
complete
overhaul.

FAST, DEPENDABLE SERVICE with FULL YEAR WARRANTY

Sarkes Tarzian, Inc., largest manufacturer of TV and FM tuners, offers unexcelled tuner overhaul and factory-supervised repair service.

Most Tarzian-made tuners received one day will be repaired and shipped out the next. More time may be required on other makes. Every channel checked and realigned per original specs. And, you get a full, 12-month guarantee against defective workmanship and parts failure due to normal usage. Cost, including labor and parts (except tubes) is only \$9.50 and \$15 for UV combinations. Replacements at low cost are available on tuners beyond practical repair.

Always send TV make, chassis and Model number with faulty tuner. Check with your local distributor for Sarkes Tarzian replacement tuners, parts or repair service. Or, use the address nearest you for fast, factory-supervised repair service.

TUNER SERVICE CORPORATION



(Factory-supervised tuner service
authorized by Sarkes Tarzian)

MIDWEST—817 N. Pennsylvania St.
Indianapolis, Ind. Box 1642
Tel: 317-632-3493

EAST—547-49 Tonnele Ave.,
Jersey City, New Jersey
Tel: 201-792-3730

SOUTH-EAST—938 Gordon St., S.W.,
Atlanta, Georgia
Tel: 404-758-2232

WEST—SARKES TARZIAN, Inc.
Tuner Service Division
10654 Magnolia Blvd., N. Hollywood, Calif.
Tel: 213-769-2720

SERVICE CLINIC continued

good idea to set the vom to the 100-mA scale, and then turn it down to the microamps scale, just to be sure that the thing isn't going to slam the meter.

Now, adjust the 1-meg control until the meter reads exactly full-scale on the microamps range. Now, connect the 10K pot across the meter terminals and adjust it so the meter deflection is reduced by exactly half. Disconnect the battery and meter, and, without moving the slider, read the resistance of the 10K pot. This is equal to the meter resistance. When the meter reading drops to half scale, the pot shunted across it will be carrying exactly half of the current and its resistance is equal to that of the meter.

Be sure to hook the test pot across the vom test leads; *not* across the meter movement inside the instrument. Why? Because many meters use series resistance in order to bring the meter-resistance up to 5K so that the 20,000-ohms-per-volt calibration will be easier. The actual meter resistance depends on the number of turns in the moving coil, the size of wire, the magnetic flux and so on. The basic movement may not be 0–50 μ A; Hickok, for example, uses a meter movement with a “bare” sensitivity of 38 μ A, and this is multiplied up to give 0–50 μ A full-scale.

So, with a little imagination, and a great deal of caution, and a few odd resistors, you can make your vom much more useful around the shop.

Signal-tracing vertical amplifier in scope

I have an Eico 460 oscilloscope that I built from a kit. It's worked fine for several years, but now I have hardly any vertical gain, even with the control wide open. The vertical gain's good for about 10 minutes after I turn the scope on, then down she goes. I've changed tubes and checked voltages, which seem to be okay. What to do?—S. H., Attleboro, Mass.

Everybody ought to have two scopes—one for working on the other one. However, you can use the oldest method of trouble-chasing there is: signal substitution. Feed an audio signal into your vertical deflection system, stage by stage. This will tell you which stage is losing gain.

The CRT takes about 50 volts to deflect the trace 1 inch (without looking up the exact figure), if you drive the deflection plates direct. So, start here. Use a signal from a test record through an audio power amplifier, or try an audio signal generator, if it has a high-

enough voltage output. Any test record containing sine-wave audio will do. Don't worry about the cartridge's or the amplifier's distortion—you're looking for gain, not checking the scope's linearity. An audio generator will probably have a hi-Z output, which you can use.

If you use a hi-fi power amplifier, put a dummy load on the speaker terminals. For instance, for a 20-watt amplifier and an 8-ohm output, use a resistor (or resistors in total) that's about 8 ohms and 20 watts or more.

Use two blocking capacitors (0.1 or .05 μ F at 600 volts) between your audio source and the scope. If you don't get enough of voltage from the amplifier's speaker output, hang one blocking capacitor off the output plate, with the other to chassis. Feed this audio directly into the vertical output-tube plates. (They're push-pull, which is why you need two capacitors.) Now, note the vertical deflection of the CRT trace. It should be about 1 inch for 50 volts of ac, which you should measure with your voltmeter. If deflection is satisfactory at the plates, go back and insert signal at the output grids. In this way, follow the vertical amplifier circuit all the way back to the input.

Somewhere along the line, you won't get the gain you should—most of these stages are pretty high-gain voltage amplifiers, and you ought to get at least a 20–25 times voltage gain through each. As you move backward from the output, you'll have to keep turning down the gain on your audio source. When you hit the spot where you *don't* have to, that'll be the faulty stage. Trouble's probably an open or leaky coupling capacitor, to judge from your description.

Bending in Heath GR-25

I've got a problem in a Heathkit GR-25 color TV. The picture pulls or bends whenever video information leaves or comes on the right side of the screen. Vertical lines will bend toward dark areas; this is actually the raster pulling, and it's been there ever since the set was assembled.

I've replaced all tubes in the horizontal section, sync and aqc, and checked everything I can think of. There is no ripple on the B+ filter capacitors, as seen with a scope. Any suggestions?—J. M., Glendale, N. Y.

This sounds very much as if you have some kind of trouble in the blanker. I would make a very careful check of that stage, being sure that all parts have the right value, all ground connections are solid, and so on.

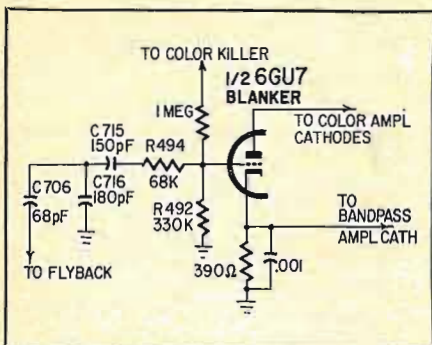

There is a strong possibility (since you've had the trouble since the set was built) that a part having the wrong value has been used. Such an error could easily cause this kind of trouble, especially if the incorrect component were in a circuit which affected the time constant of the blanker.

Suspect C706, C715, C716, R494, and R492, for example, in the Heath diagram. It is awfully easy to misread a color band on a resistor, and come up with 3,300 ohms instead of 330, for example. This would make the blanking-interval time constant wrong, and video information would get into the blanker, affecting the raster and the picture.

(Of course, I don't make mistakes. Did you know that a 1B3 won't work with a 330-ohm resistor in place of a 3.3-ohm unit? It won't.)

"Gray spot" on raster

I have a 23-inch TV with vertical problems. There's a light gray spot on the screen at the top. I can't get rid of it by adjusting height or linearity controls —N. O. B., Springfield, Mass.

No wonder! This is almost certainly a defect in the screen of the CRT! Probably a rebuilt tube.

FIXED SPOT IS DEFECT IN SCREEN

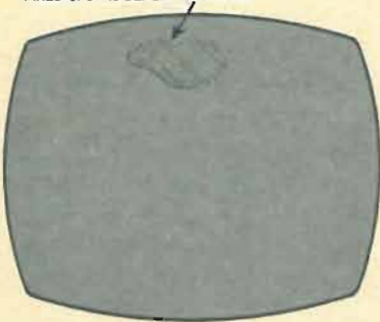

Problems caused by bad height or vertical linearity would show up all the way across the screen, covering complete scanning lines. A spot such as this could hardly be caused by this circuit, or by any other in the set itself.

Interchangeable scope tubes?

I have an EICO 425 scope with a 5BP1 tube. A while ago, I bought a surplus 5BP4 tube. I put this into the scope, and got no focus or intensity adjustment, and the pattern is about 3/16-inch wide! What changes do I have to make to use this tube? Other tubes in the scope are okay.—H. K., Long Beach, Calif.

I'm afraid the only change you need to make is to throw that surplus tube away and get a good one! The 5BP1 and 5BP4 tubes are fully interchangeable. The only difference is in

the phosphor. The P1 phosphor is the standard scope phosphor, green with medium persistence; the P4 phosphor is the same as that used in TV picture tubes—white, with about the same persistence.

The basing and all electrical characteristics of these two tubes are the same. So, the 5BP4 should have worked, but made a white pattern.

The only hope I can see in this case would be to check the base pins of the 5BP1; you just might have a bad solder joint there, which is opening one of the elements—from the symptoms, maybe the screen grid. END

Brand New and Exclusive!

Discriminates Between Desired Signal and Unwanted Noise!

3-Way Combination
FREE SPACE
STANDING WAVE
MAGNETIC
ANTENNA
 (UHF-VHF-FM-COLOR)

Here for the first time, is an antenna with the unique ability to discriminate between the desired signal and unwanted noise! A complete absence of minor lobes and an extremely high front to back ratio are characteristics of these antennas. This is made possible by the development of the Free Space Standing Wave Magnetic Drive Antenna system (F.S.M.). The outstanding electrical qualities, combined with the simplified mechanical construction of this system yields a total performance package unparalleled in today's market. 4 models, 60-inch to 180-inch boom, all modestly priced.

There's a Quality Built S & A Antenna to Meet Every Need!

S&A Electronics Inc.
 Manufacturers of the TARGET ANTENNA
 210 West Florence St. • Phone (419) 693-0528 • Toledo, Ohio 43605

Gene Frost was "stuck" in low-pay TV repair work. Then two co-workers suggested he take a CIE home study course in electronics. Today he's living in a new house, owns two good cars and a color TV set, and holds an important technical job at North American Aviation. If you'd like to get ahead the way he did, read his inspiring story here.

IF YOU LIKE ELECTRONICS—and are trapped in a dull, low-paying job—the story of Eugene Frost's success can open your eyes to a good way to get ahead.

Back in 1957, Gene Frost was stalled in a low-pay TV repair job. Before that, he'd driven a cab, repaired washers, rebuilt electric motors, and been a furnace salesman. He'd turned to TV service work in hopes of a better future—but soon found he was stymied there too.

"I'd had lots of TV training," Frost recalls today, "including numerous factory schools and a semester of ad-

vanced TV at a college in Dayton. But even so, I was stuck at \$1.50 an hour."

Gene Frost's wife recalls those days all too well. "We were living in a rented double," she says, "at \$25 a month. And there were no modern conveniences."

"We were driving a six-year-old car," adds Mr. Frost, "but we had no choice. No matter what I did, there seemed to be no way to get ahead."

Learns of CIE

Then one day at the shop, Frost got to talking with two fellow workers who were taking CIE courses... pre-

paring for better jobs by studying electronics at home in their spare time. "They were so well satisfied," Mr. Frost relates, "that I decided to try the course myself."

He was not disappointed. "The lessons," he declares, "were wonderful—well presented and easy to understand. And I liked the relationship with my instructor. He made notes on the work I sent in, giving me a clear explanation of the areas where I had problems. It was even better than taking a course in person because I had plenty of time to read over his comments."

Studies at Night

"While taking the course from CIE," Mr. Frost continues, "I kept right on with my regular job and studied at night. After graduating, I went on with my TV repair work while looking for an opening where I could put my new training to use."

His opportunity wasn't long in coming. With his CIE training, he qualified for his 2nd Class FCC License, and soon afterward passed the entrance examination at North American Aviation. "You can imagine how I felt," says Mr. Frost. "My new job paid \$228 a month more!"

"CIE training helped pay for my new house,"

says Eugene Frost
of Columbus, Ohio



Currently, Mr. Frost reports, he's an inspector of major electronic systems, checking the work of as many as 18 men. "I don't lift anything heavier than a pencil," he says. "It's pleasant work and work that I feel is important."

Changes Standard of Living

Gene Frost's wife shares his enthusiasm. "CIE training has changed our standard of living completely," she says.

"Our new house is just one example," chimes in Mr. Frost. "We also have a color TV and two good cars instead of one old one. Now we can get out and enjoy life. Last summer we took a 5,000 mile trip through the West in our new air-conditioned Pontiac."

"No doubt about it," Gene Frost concludes. "My CIE electronics course has really paid off. Every minute and every dollar I spent on it was worth it."

Why Training is Important

Gene Frost has discovered what many others never learn until it is too late: that to get ahead in electronics today, you need to know more than soldering connections, testing circuits, and

replacing components. You need to really know the fundamentals.

Without such knowledge, you're limited to "thinking with your hands" ... learning by taking things apart and putting them back together. You can never hope to be anything more than a serviceman. And in this kind of work, your pay will stay low because you're competing with every home handyman and part-time basement tinkerer.

But for men with training in the fundamentals of electronics, there are no such limitations. They think with their heads, not their hands. They're qualified for assignments that are far beyond the capacity of the "screwdriver and pliers" repairman.

The future for trained technicians is bright indeed. Thousands of men are desperately needed in virtually every field of electronics, from 2-way mobile radio to computer testing and troubleshooting. And with demands

like this, salaries have skyrocketed. Many technicians earn \$8,000, \$10,000, \$12,000 or more a year.

How can you get the training you need to cash in on this booming demand? Gene Frost found the answer in CIE. And so can you.

Send for Free Book

Thousands who are advancing their electronics careers started by reading our famous book, "How To Succeed In Electronics." It tells of the many electronics careers open to men with the proper training. And it tells which courses of study best prepare you for the work you want.

If you'd like to get ahead the way Gene Frost did, let us send you this 40-page book free. With it we'll include our other helpful book, "How To Get A Commercial FCC License." Just fill out and mail the attached card. Or, if the card is missing, write to CIE at the address below.

CIE
Cleveland Institute
of Electronics
1776 E. 17th St., Dept. RE-31
Cleveland, Ohio 44114

Accredited Member National Home Study Council

ENROLL UNDER G.I. BILL

All CIE courses are available under the new G.I. Bill. If you served on active duty since January 31, 1955, or are in service now, check box on reply card for G.I. Bill information.



Solid-State C-D Ignition Under \$25

Here's a capacitor-discharge system that's simple and easy to build, that will put you with the "go" crowd

By BRICE WARD

IF YOU'VE BEEN HANKERING FOR A compact and powerful solid-state system to add a little zest to the family chariot, try this one for size. No bigger than a couple of packs of cigarettes, it packs a 40-kV punch. It won't crown you king of the drag strip, of course, but if your buggy can benefit from an improved ignition system, you can soon be on your way—for darned little effort or cash outlay.

This project started when the price of most capacitor-discharge ignition systems seemed high for experimenting. I wondered if it were possible to build one for about half the cost of current systems, and if so . . . what kind of performance would it have?

It was obvious that price and per-

formance depended primarily on the availability of a high-quality, low-cost inverter transformer. Also, using a common-emitter circuit could mean fewer resistors, lower cost and better efficiency. A search through many parts catalogs suggested the Triad TY68-S, priced at \$7.52.

The rated full load supply voltage quoted by Triad for the TY68-S may seem low, but operating as this system does, the actual voltage stored on C1 is about 375 volts measured with a vtvm at 14.7 volts input. This allows more than adequate voltage to be supplied to the sparkplugs on starting and idling and even though the voltage may drop slightly as RPM increases it will never become inadequate below 6,000 RPM.

Inverter efficiency is high. As shown in Fig. 1, the 26.5-volt collector swing has less than 10% overshoot. The 2-volt drive requirement is low, and idling current for the unloaded inverter is about 0.6 amp—lower than any commercial system I've seen. The output waveform, using a Mallory U12 coil and with 12 volts at the inverter, is shown in Fig. 2.

The principles used in this project are given in Motorola's *Power Transistor Handbook* on page 115. They show a single transformer inverter in a common-emitter circuit.

Fig. 3 is the schematic of the ignition system. The inverter runs at 2 kHz and uses a bridge rectifier to charge capacitor C1 during the points-closed portion of the ignition cycle.

The triggering circuit was designed to accomplish four things: First, it has a relatively high input impedance (compared to other triggering circuits),

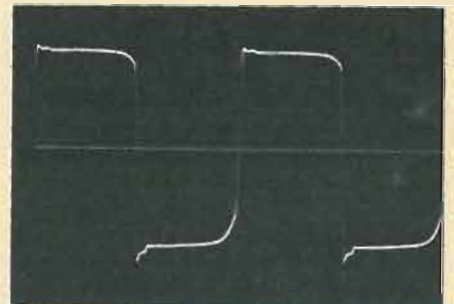
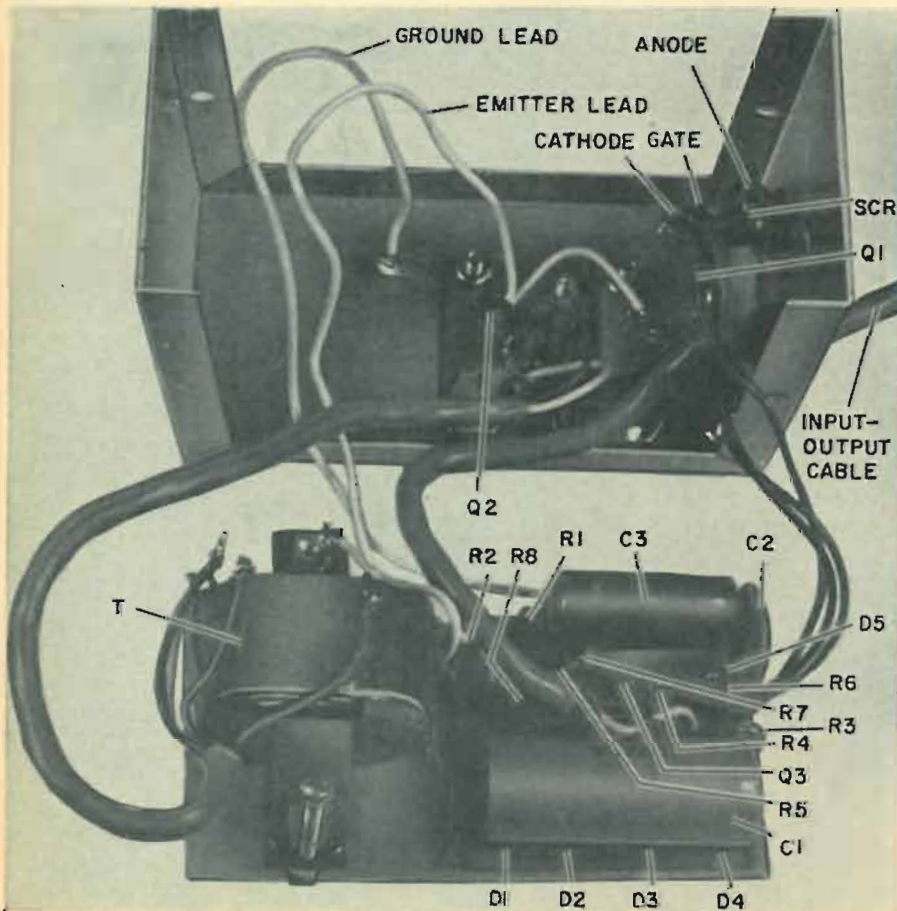

Fig. 1—Waveform found at the Q2 collector is shown with normal 12 volts dc at the input lead of the inverter.

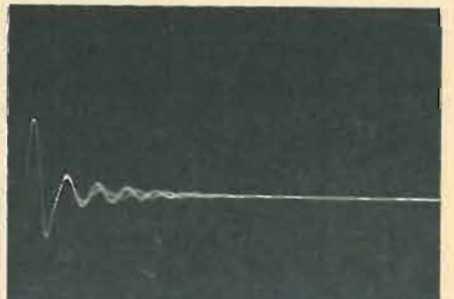

Fig. 2—Ignition-coil output using C-D system. Peak at left measures 40 kV above the zero center line on scope.

Location of major components which are mounted within the equipment cabinet.

allowing it to function with dirty points. Second, it will deliver a pulse with a 10-volt swing to a tachometer attached to the distributor connection. Third, high-voltage transients such as an arc from the ignition-coil tower to the distributor or 12-volt connection on the coil will not damage transistor Q3. Fourth, the circuit can easily be adapted to photoelectric or magnetic triggering.

During points-closed operation, capacitor C3 is charged to the supply voltage minus the drop across diode D5 (Fig. 4). The charging time constant is short enough to allow, theoretically at least, operation to 10,000 rpm in an 8-cylinder engine.

The drop across D5 is maintained by current flow through R4 and serves to bias the SCR gate to -0.6 volt with respect to the cathode. Q3 is turned on as the points open, discharging C1 through the primary of the ignition coil to supply the stepped-up high-voltage pulse to the plugs via the distributor.

Commutation is a term you will see frequently in connection with SCR's and it refers to the means used to turn the SCR off after the desired period of conduction. Some systems "crowbar" (short) the output of a self-biased common-collector inverter. This shuts the inverter off, allowing the flywheel action of the coil primary to finish the turnoff of the SCR.

Since this circuit does not use a self-biased inverter, the reverse swing of the coil is used to commutate the SCR, a system which has proved very satisfactory.

C2 (Fig. 3) is used to prevent too swift an application of voltage to the anode of the SCR, which would result in a phenomenon known as the dV/dT effect. A too-rapid application of voltage to the anode can cause the SCR to turn on without a gate pulse. This uncontrolled firing would raise (and has raised) hob with an engine. The value of R3 is not really critical (though it should be greater than 1 megohm), since its main purpose is to discharge C1 when power is removed from the circuit.

The secret of both the size and cost of this unit is embodied in the Triad TY68-S inverter transformer. This transformer originally was designed for photoflash circuits. Although relatively low in cost, it's very efficient.

Since the entire circuit is assembled on a circuit board, you'll want to have a negative made of the full-size artwork shown in Fig. 6. You can have a copper-backed board made by a commercial shop or do the job yourself using materials and instructions supplied by any of several manufacturers listed in parts catalogs.

Drill all holes except the two transformer mounting holes with a No. 55

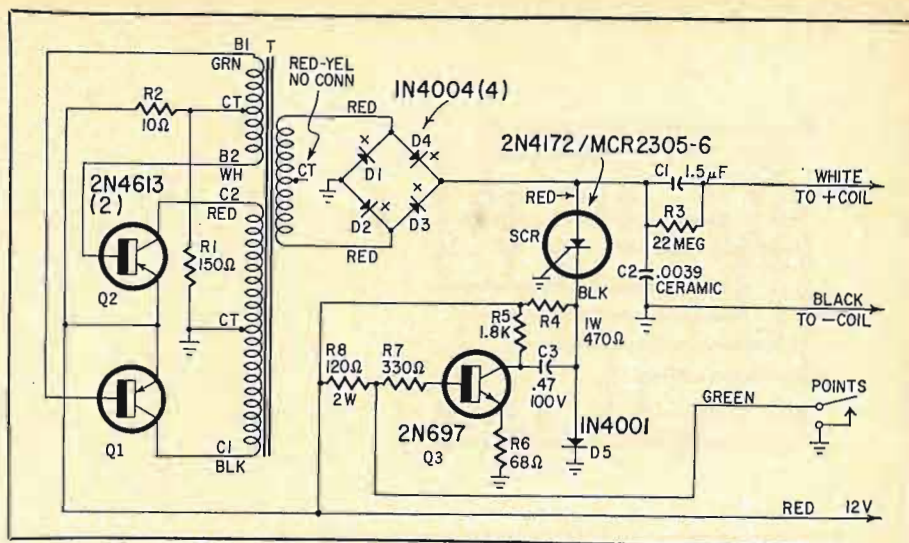

Fig. 3—Schematic of the C-D SCR ignition system. Heart of circuit is dc-to-dc inverter transformer, which must produce efficient drive to SCR triggering device.

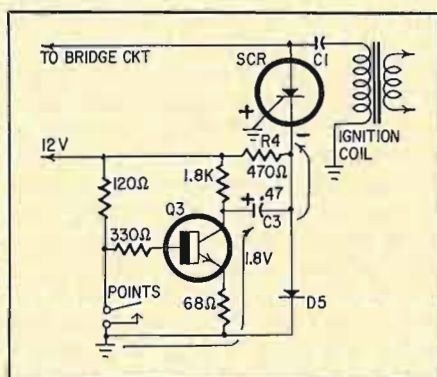

Fig. 4—When the distributor points open, system fires, and current flows as indicated by arrows on the diagram.

- PARTS LIST
- R1—150 ohms, 1/2 watt
 - R2—10 ohms, 1/2 watt
 - R3—22 megs, 1/2 watt
 - R4—470 ohms, 1 watt
 - R5—1.8K, 1/2 watt
 - R6—68 ohms, 1/2 watt
 - R7—330 ohms, 1/2 watt
 - R8—120 ohms, 2 watts
 - C1—1.5 μ F, 400 volts, metallized Mylar (Aerovox V146Z or equivalent; Newark 16F520)
 - C2—3,900 pF, 500 volts, temperature-stable disc (Centralab CF-392 or equivalent)
 - C3—0.47 μ F, 100 volts (Mallory PVC or equivalent)
 - D1, D2, D3, D4—2 transistor mounting kits, Motorola type MK-15
 - D5—Motorola 1N4001 or equivalent
 - Q1, Q2—Motorola 2N4613 or equivalent
 - Q3—Texas Instruments 2N697 or equivalent
 - SCR—400 volts, 8 amps (Motorola 2N4172/MCR 2305-6 or equivalent)
 - T—inverter transformer, 12.6 volts to 250 volts (Triad TY68-S or equivalent; Newark 3F-438)
 - Cabinet—LMB type 876 Jiffy Box, 4 x 2 x 2 3/4 inches, or equivalent

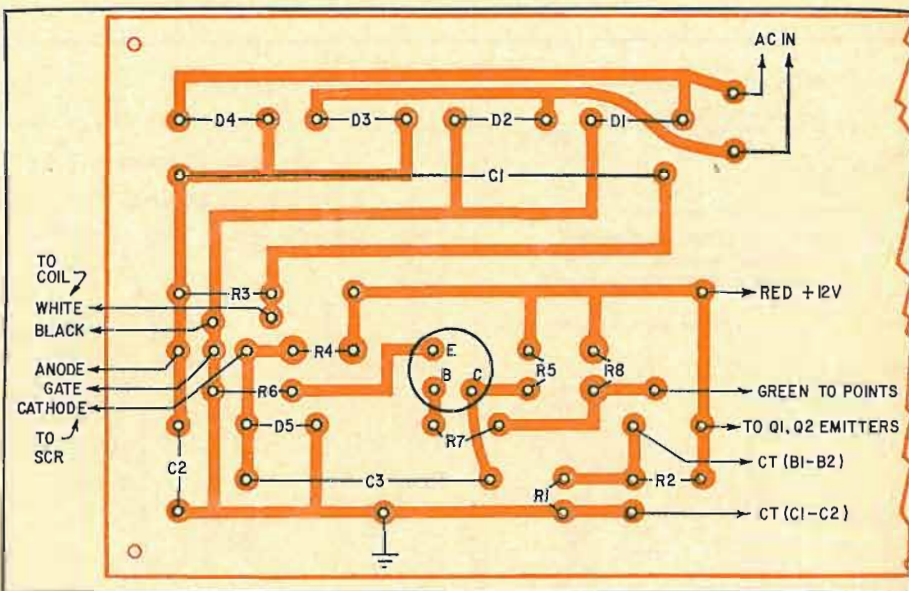

Fig. 5—Mount components on the board using this diagram as a guide. Be sure to drill all holes and cut board to size before putting parts in place. Solder carefully and work rapidly, as too much heat can destroy foil or components. Use a heat sink.

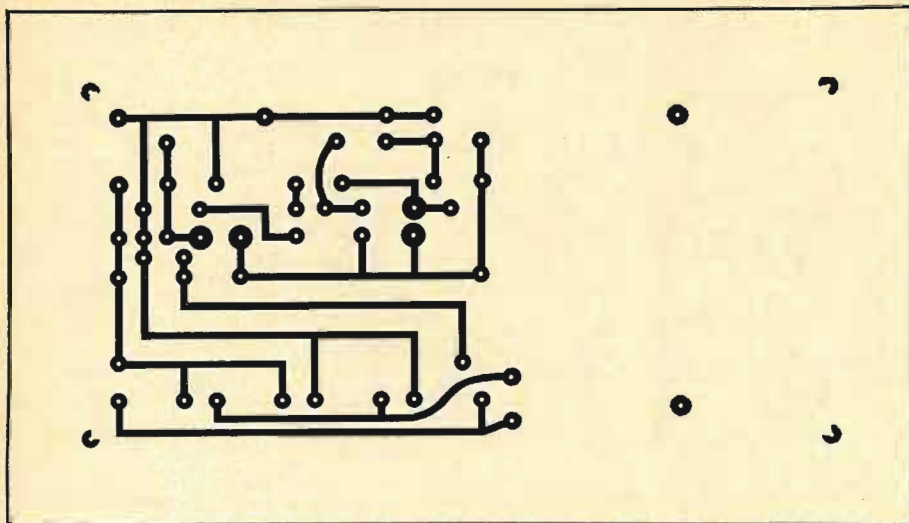

Fig. 6—This template is the exact pattern of the circuit board used in the system. The small C-shaped markers near the corners indicate the final size of the board.

high-speed steel drill. Drill the two transformer mounting holes with a No. 33 drill. Shear the circuit board to size, and you're ready to install the components (Fig. 5).

Drill holes in the chassis and install the transistor sockets and transistors. Install the SCR with the anode solder lug inside the case. The SCR should be insulated from the chassis using the mica washers or other insulating material supplied with the device.

The transformer requires some special treatment. First, cut all leads except the two high-voltage leads so they extend just to the edge of the transformer frame—about $\frac{3}{4}$ inch. Carefully untwist all the double primary leads. With a knife or sandpaper remove the

enamel insulation, then twist the leads and carefully tin them. Also strip and tin the two single leads.

In the prototype, a 10-inch length of four-conductor vinyl-jacketed intercom cable connects the transformer to the transistor sockets. If you use a similar procedure, try to obtain a cable having red, black, green and white leads. Remove 2 inches of vinyl jacket from each end of the cable and strip $\frac{1}{2}$ inch of insulation from each lead. Connect the red lead to C2, the black lead to C1, the green lead to B1, and the white lead to B2, the transformer primary taps.

Connect the other end of the green lead to Q1 base, the black lead to Q1 collector, the white lead to Q2 base, and

the red lead to Q2 collector. A short jumper of insulated wire connects the two emitters, and a 10-inch single-conductor lead is attached to Q2 emitter as a return to the circuit board.

Take a 5-inch length of the same cable and strip the vinyl jacket, so you can remove the red, green and black leads. Strip $\frac{1}{4}$ inch of insulation from each end of each piece of wire and connect as follows: black to the cathode of the SCR, and red to the anode lug located inside the case. A long section (3 or 4 feet) of the vinyl-jacketed cable connects the chassis unit to the automobile system.

Wire the remainder of the unit as indicated in Fig. 3. Lead length and dress aren't important. Install the transformer on the circuit board using 4-40 machine screws and nuts. Connect the two red high-voltage leads to the diode bridge as shown in Fig. 5.

Mount the ignition system on the fender ledge or fire wall and follow the instructions below, using the two split-diagonal terminal boards shown in Fig. 7. Here's how:

Step 1—disconnect all leads from the coil stud where the ignition-switch lead is attached. Remove all clips, stampings and washers from the coil stud itself.

Step 2—install terminal board with a red and a white wire to the coil stud from which the leads were removed. Replace only the lock washer and nut.

Step 3—connect the leads removed in Step 2 to the outer terminal on the board and install a lock washer and nut.

Step 4—disconnect all leads from the coil stud to which the distributor lead is connected. Remove any clips, stampings or washers.

Step 5—install the terminal board with a green and a black wire to the coil stud from which the leads were just removed. Replace only the lock washer and nut.

Step 6—connect the leads removed above to the outer terminal on the board. Install and tighten the lock washer and nut.

Collector-emitter shorts will cause the inverter to quit. This is the most common problem you'll experience. Of course, if you should get the feedback leads reversed, the system will quit, too—so pay particular attention to this point.

Beyond these potential troubles, circuit-board construction allows little room for wiring errors, and you should enjoy the product of your efforts for a long time. **END**

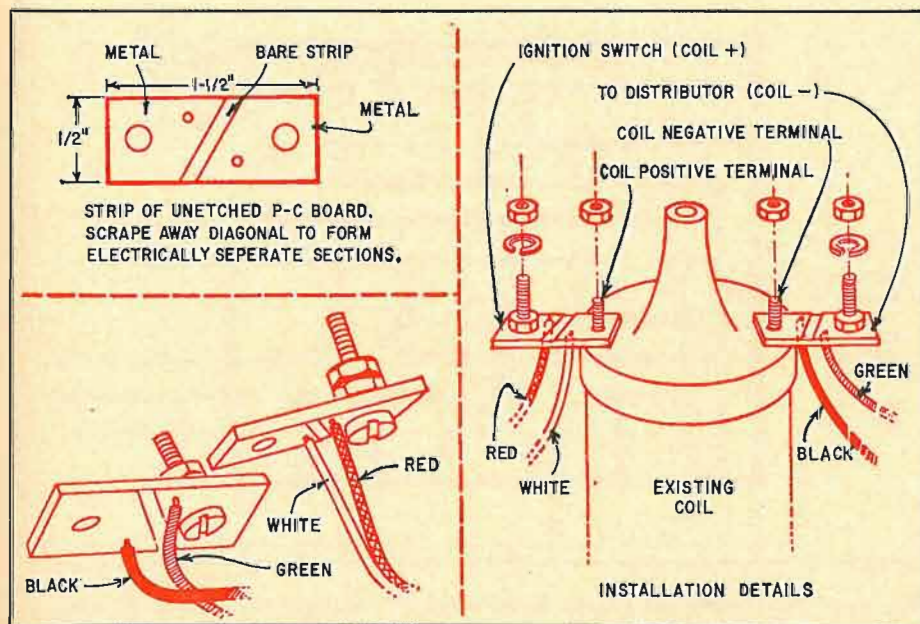

Fig. 7—Follow these installation details when connecting system to the ignition coil.

Cartridge Systems and Quality

Four highly individual cartridge-construction concepts are related to actual sound quality—producing some surprising results By LEONARD SILKE

PERHAPS THE LEAST CONSIDERED COMPONENT in a music system is the phono cartridge. Yet, this is where the reproduced sound begins. To the cartridge falls the extraordinarily delicate job of translating the highly complex undulations of a record groove into a minute electrical current which the amplifier will expand to levels capable of driving your speaker. This is no mean trick, considering the comprehensive range of information contained in a modern stereo groove. With two channels of information, one cut into each of two opposite walls, the stylus is required to move freely to any point within a 180° arc across the groove.

Translation of this mechanical motion into an electrical signal is not without losses; no cartridge is a perfect transducer. And, no two cartridges sound quite the same, even among those of "identical" manufacture.

In this report, we will examine four new cartridges, each of which has been selected as representative of a type using a different transduction system.

Basic electrical theory tells us that moving a magnet near a coil will generate a voltage. Two of the four cartridges are of this magnetic variety. It is possible to generate a voltage using either a stationary magnet and a moving coil, a stationary coil and moving magnet, or a stationary magnet and coil.

How do you obtain a signal when both components are static? Any magnet has an area surrounding it that is affected by its flux field. If a piece of iron is placed within the field, it will assume some properties of a magnet. Any motion of the induced magnet in the presence of a coil will generate a signal of some value.

The ADC-10E cartridge represents an application of this principle. Magnetism is induced into a tiny iron collar by a fixed permanent magnet. This collar is at the end of the stylus lever opposite the point and is moved

between two poles directly in relation to the groove motion.

The Stanton 581EL is the latest cartridge to use the popular moving-magnet principle. The magnet itself is at the reverse end of the stylus lever, and is moved directly relative to the record groove.

In some cartridges the moving stylus bar is coupled directly to a pair of miniature coils. These rotate in the vicinity of a fixed magnet.

Magnetism is not the only way to excite a transducer. Nonmagnetic cartridges have been around for a long time. The popular and inexpensive piezoelectric or crystal cartridge is probably used in more record players than any other type.

Only recently, however, have nonmagnetic cartridges assumed an aura of respectability similar to that of magnetic types. The problem has been one of mass and stiffness. Piezo cartridges operate by stressing a crystalline substance that generates electricity when flexed. Until recently, the force required to flex the elements was consid-

erable. Cartridges were stiff and large. A long and heavy stylus lever was needed to provide sufficient twist to produce a reasonable signal.

Output from these types is high. Further, the piezo cartridge is essentially amplitude-sensitive; that is, its output voltage depends on *how far* the stylus moves back and forth in the groove. By contrast, a magnetic cartridge generates a voltage which is proportional to *how fast* the stylus moves. This means in practice that a piezo cartridge will self-equalize, while a magnetic type requires external equalization. There is a second potential advantage to nonmagnetic cartridges: They will not accept induced hum from nearby motors or transformers, thus simplifying installation.

With these thoughts in mind, we decided first to test the Grado B. (Fig. 1). This cartridge uses a pair of piezoelectric strain generators designed to provide a response similar to that of magnetic generators. The Grado B therefore requires equalization as does a magnetic cartridge. It further differs from the usual piezo cartridge in that its output voltage is as low as that of most magnetics; it must therefore have a preamplifier.

A nonmagnetic cartridge can be made physically lighter than a magnetic unit, and the Grado B weighs 3.5 gm. This compares to a typical magnetic type at 6–10 gm. Reduced mass at the end of the stylus arm will improve tracking significantly, particularly if the record is warped. (And what record is perfectly flat?)

So far, all cartridges mentioned have one common trait: All are electrical generators—they transform the mechanical motion of the stylus assembly into an equivalent electrical signal.

For as long as there have been cartridges, there have been attempts to design nongenerating units. The alternative, of course, is to use the stylus mo-

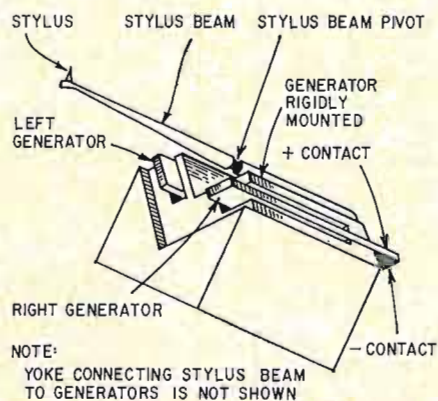

Fig. 1—Solid-state (actually piezoelectric crystal) generators require long stylus-lever arms to get the proper amount of mechanical "amplification"—typical action of "hard" (crystal or ceramic) cartridge.

tion to modulate an externally generated voltage. The most recent of these types is the new Euphonics CK-15-LS. This cartridge requires an external transistorized power supply to provide the fixed dc voltage which is modulated by the flexing motion applied to the two semiconductors.

Stylus motion is imparted to two ultraminiature silicon elements (Fig. 2) called Pixies. As they are flexed by stylus movement in the groove, they change resistance. This resistance variation affects the dc output of the power supply. Again, nonmagnetic construction results in a very lightweight (2-gm) cartridge.

So, here we have them: The Euphonics is a voltage modulator; the Grado B is a solid-state (piezoelectric) generator; the ADC-10E is an induced-magnet generator; and the Stanton 581EL a moving-magnet generator. Four cartridges with four different principles of operation—yet all are assigned the same job.

Audiophiles have argued endlessly over the relative merits of these systems. Our object in testing these devices was to determine if one basic car-

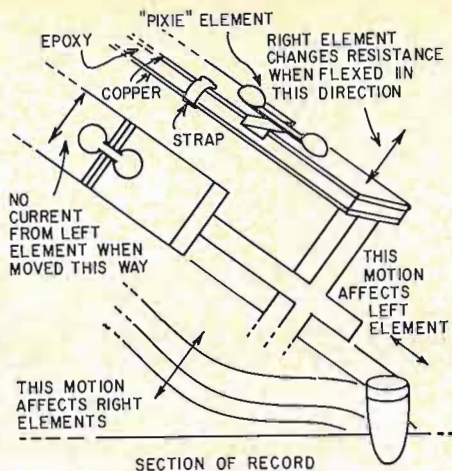

Fig. 2—Another solid-state cartridge—a modulated-dc unit—uses silicon chips which vary resistance as stylus flexes.

tridge concept is capable of giving a characteristic and identifiable quality. We don't imply that the cartridges selected for these tests are necessarily superior to any others. They were chosen because they represent various attempts to recreate the original sound as recorded on stereo records.

All the cartridges, save one, have elliptical styli. The exception is the Grado B which is supplied with a conical stylus but is also available with an elliptical stylus.

All cartridges were mounted on slides to fit the Empire 980 arm. The Euphonics is inoperable without its power supply which is used between the cartridge and the preamp (or measuring equipment). The supply has a slide switch which may be set for an output similar in characteristic to a magnetic cartridge (low) or one that supplies an RIAA-compensated 0.5-volt (high) output. All our tests were performed in the low position.

In the listening tests all the cartridges were subjected to identical conditions. Only one stereo amplifier, pre-amplifier and speaker pair were used for all listening tests and measurements. Each cartridge was used to play the same group of records.

The tests

1—Output: The test record is the CBS Labs STR-100. Output is from a standard-velocity 1,000-Hz signal recorded first on the left and then on the

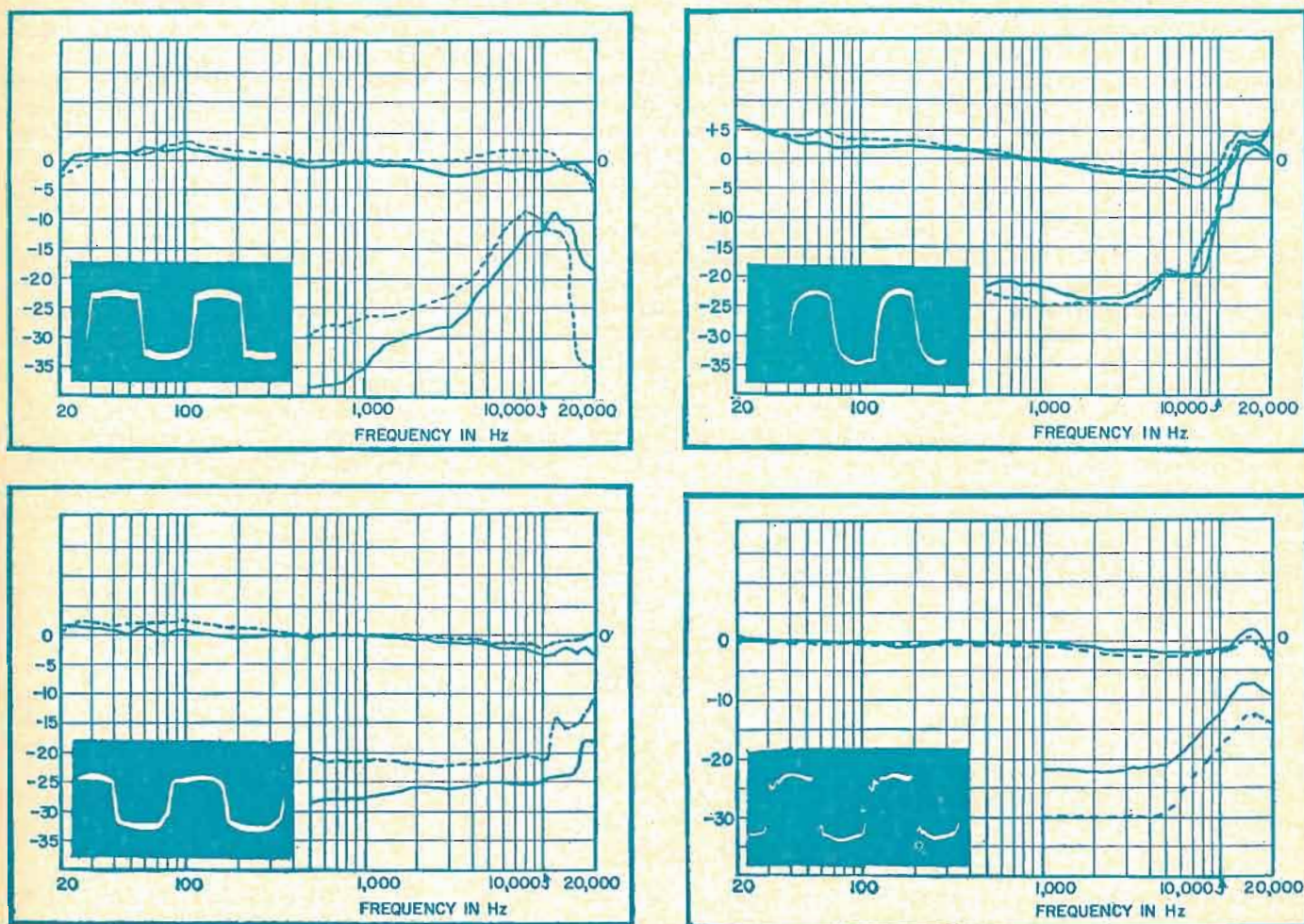

Fig. 3—Measured frequency response (upper curves) and channel separation (lower curves) of four popular phono cartridges. Solid lines represent left channel, dashed lines, right channel. Cartridges are Euphonics CK-15-LS (upper left) Grado B (upper right) ADC-10E (lower left) and Stanton 581EL (lower right). Scope traces show cartridge action on 1,000-Hz test record.

Table
Measured Specifications

1. Output Per Channel: from 1 kHz at 3.54 cm/sec recorded velocity

Euphonics	left	12 mV.
	right	11 mV.
Grado B	left	4.8 mV.
	right	4.95 mV.
ADC-10E	left	3.5 mV.
	right	3.6 mV.
Stanton	left	4.5 mV.
	right	4.6 mV.

2. Minimum Tracking Force Required

Euphonics	1 gram
Grado B	1.5 grams
ADC	1 gram
Stanton	1 gram

3. Dynamic Compliance (x 10⁻⁶)

Euphonics	Lateral	4.5
	Vertical	6.3
Grado B	Lateral	1.6
	Vertical	1.6
ADC	Lateral	12.5
	Vertical	24.8
Stanton	Lateral	4.5
	Vertical	4.2

4. Intermodulation Distortion

Euphonics	Lateral	+6 dB	2.5%
		+9 dB	4.0%
	Vertical	+6 dB	2.2%
		+9 dB	3.2%
Grado B	Lateral	+6 dB	1.5%
		+9 dB	7.5%
	Vertical	+6 dB	3.0%
		+9 dB	3.8%
ADC	Lateral	+6 dB	1.0%
		+9 dB	2.2%
	Vertical	+6 dB	3.0%
		+9 dB	5.0%
Stanton	Lateral	+6 dB	1.2%
		+9 dB	1.6%
	Vertical	+6 dB	4.2%
		+9 dB	6.2%

Notes on the Square-Wave Photos

The square waves are from the lateral cut of CBS Labs' STR-111. The frequency is 1,000 Hz.

Interpretation seems to bear little relationship to subjective listening results.

Note also that none of the cartridges show a sharp oscillatory rise at the leading edge of the wave top. Stylus mass resonances seem to be well under control on all samples. The slight "bobble" noted on the leading edge of all traces is on the record itself.

Finally, the small spurious responses seen at random points along the wave are disc-noise impulses, nothing more.

right channel. The high output of the Euphonics could overload some transistor (and tube) inputs. The output test is not necessarily a qualitative indication.

2—*Minimum tracking force required:* This has been determined from several factors. The final figure contains a safety factor. It is by no means the *minimal* force figure; it is the amount of force that will permit tracking—in a good, low-mass, high-compliance arm—on the vast majority of records. A few may require more; many will get by with less. However, a tracking force figure is one case where it is better to err on the high side. Double the force required is much preferred to an even slightly too-light force. Contrary to popular belief, underweighted arms severely damage records due to stylus rattle in the groove. The wear increase due to reasonable overforce is insignificant.

3—*Dynamic compliance:* This is a measurement of the compliance *under use*. It bears no relationship to the usual static-compliance figures quoted in advertising. The figures also seem to show up the pointlessness of the cartridge-compliance race. Apparently, the wide range of figures recorded has little bearing on performance of the cartridge. Again, a CBS Labs disc—the STR-111—was used.

4—*Intermodulation distortion:* This is measured from the same record as above. The +9-dB figures represent higher degrees of modulation than the lower figure. The +6-dB point represents a reading typical of average recording levels. Lateral-response distortion is not always identical to vertical-response distortion. Both, of course, are important in stereo reproduction. If the figures appear surprising in light of figures usually quoted for amplifiers and the like, rest assured that they are state-of-the-art. Only a few years ago a 5% figure was considered outstanding.

The +9-dB figures are included as an indication of what happens on a heavily modulated record. These figures can be significant. Certainly, they must be counted as a cartridge safety factor.

5—*Frequency response and channel separation:* Note that general rises or dips in response extremes in the graphs can be corrected by tone controls. Note also that some of the bass rise, particularly in the right channel, is actually on the test record (CBS Labs, STR-100).

Channel separation in decibels is not nearly as important as linearity. The relative separation loss between 500 to 10,000 Hz is particularly important. The

more gradual this loss (there is always some), the better the stereo. It is worthy of note, too, that all these cartridges provided an excellent subjective stereo effect in our listening tests.

Perhaps the most startling fact to come out of these evaluations was that each of these divergent systems resulted in nearly identical sound quality. Differences are very small indeed. Three categories were chosen to describe the overall sound of each cartridge: bright, neutral and soft (dull). None fell into the last category. Even a brief look at the response curves reveals no lack of high-frequency response. The ADC was most neutral in sound. The Euphonics leaned toward the bright side. The Grado B and Stanton fell in between. Both the Euphonics and Grado B sounded a bit uncomfortable on records with high-frequency boost. However, this is something that could be adjusted in multiple-speaker systems. Sonically, any of the cartridges listed is worthy of the finest musical systems.

One fact remains; that is price. The ADC-10E is \$49.50. The Stanton 581EL is \$49.50; including a built-on and effective dust brush. The Euphonics CK-15-LS is \$55.00, including the power supply. The Grado B is \$19.95 (the elliptical version is, to be sure, \$32.50).

Which one is "best"? This is a highly subjective and personal choice. One man's chocolate is another's strawberry. It is entirely conceivable that any expert listener might place this group in any order. With so divergent a group of systems, nevertheless, all come close to that ideal: the component that ceases to have an identity of its own, becoming instead a window on the concert hall.

END

Radio-Electronics Is Your Magazine!

Tell us what you want to see in it. Your suggestions may make it a better magazine for the rest of the readers as well as yourself. Write to the Editor, RADIO-ELECTRONICS, 154 West 14th St., New York, N. Y. 10011.

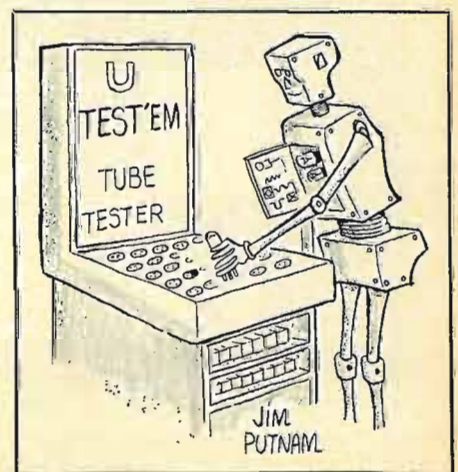

Circuit-Breaker Testing

Our service editor describes the "black box" that he built for a quick-check evaluation of all types of TV and radio circuit breakers

By JACK DARR

THE BIG COLOR SET SAT ON THE BENCH, and I sat on my stool and glared at it. "Everything" had been checked—B+ current well within tolerance, tubes okay, no capacitor leakage. Turned the thing on, and in 90 seconds "pweenk!" out went the circuit breaker.

I got mad. Picking up a test lead, I clipped it right across the breaker terminals, turned the set on, and spat, "All right, smoke, darn you!" It didn't—but 20 minutes later, the receiver was on its way home with a new circuit breaker, and I was on my way to the coffee shop feeling very bitter at having wasted an hour and a half.

I'm sure it's safe to assume we've all had this trouble at one time or another, ever since they started using small in-set circuit breakers. I remembered having had the same problem in an old Raytheon set, years ago. Half a day checking for nonexistent intermittent shorts, and it turned out to be a bad circuit breaker! When a circuit breaker kicks out, there are two possible causes: an intermittent short in the power supply, or a breaker that won't carry its rated current!

A very simple gadget will give a fast, reliable circuit-breaker analysis and eliminate half the problem right away. The same device can also speed the isolation of real troubles in the power supply. So, I decided to build a "black-box" breaker checker.

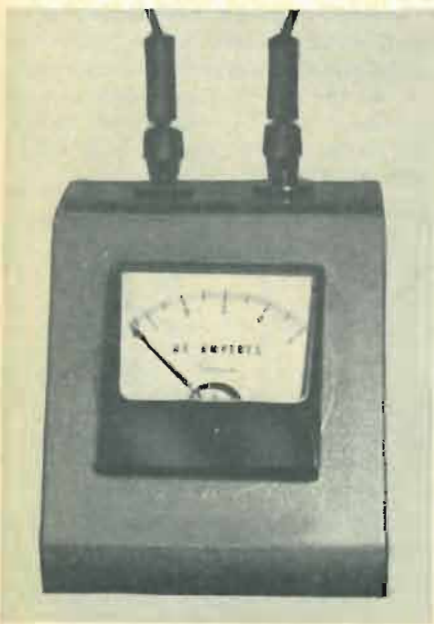

Ammeter shows current through breaker.

Each breaker has two important ratings: the hold current, which is the amount of current that the breaker must carry without opening, and the break current. The table shows a list of breakers used in US TV sets and gives the correct hold and break ratings for each. This is all we need to know.

I made the astute observation that to read ac, I needed an ac ammeter. (How about that!) Since ac ammeters are scarce in TV shops (they're used mainly by electricians) I got one (0-5 ac amps) and put it in a metal meter box with banana jacks on the top.

This accomplished, I could open one of the leads to the breaker, hook the meter in series with it, and read the actual current being drawn by the set. When this reading is normal and the breaker still kicks out, there's got to be something wrong with the breaker. To find the normal current, simply check the hold-current rating of the breaker as shown in the table.

With the same meter, it's also possible to check the power supply: either the B+ supply current, or—by putting the ammeter in the primary—the overall currents drawn by the set. In the B+, this is invaluable for catching such troubles as leaky filter capacitors, current overload from the horizontal-output tube, and so on.

The box also is invaluable for checking power transformers. Put the ammeter in the primary, pull the low-voltage rectifier (or fuse) and unhook the filament winding on one side—in other words, disconnect all normal loads. If the transformer draws more than a fraction of an amp (iron-loss current is usually less than 0.1 amp), it's internally shorted. A genuine internal short will draw several amperes, so there's seldom any doubt about it. Takes only a minute compared to the half hour or more you'd spend waiting for the transformer to burn and send up smoke signals.

As usual, there are several possible metering techniques. Triplett has an adapter (model 10) which fits the model 310 pocket vom, transforming it into a "clamp-on ammeter." The adapter is a current transformer with a hinged core which is opened and clamped around either one of the leads in the circuit. (If you get both of them, the fields cancel and you get no reading at all.) This type of meter is handy—if you make a lot of current measurements—because it reads by induction and doesn't require

breaking the lead to measure current.

There's a third simple way to read breaker and primary currents: the "Ohm's Law Special." (This is the technique I actually used to check the breaker current in that color set; at that time, I didn't have an ac ammeter either!) Put a 1-ohm resistor in series with the circuit, hook a 0-3-volt ac meter across the resistor, and read currents up to 3 amps directly. This is an automatic Ohm's-law computer. One volt equals 1 amp through 1 ohm, or $E=IR$ (see drawing in Fig. 1). The accuracy of this technique is as great as that of the resistor used and the accuracy of your ac voltmeter. The standard 5- and 10-watt replacement-type resistors are usually very close to rated value, and the shop vom is usually accurate enough for practical work.

Any of these three methods will do nicely for home servicing and in-the-set checking, but an additional "black box" was needed to make a full check on a breaker, for both hold and break current. This meant some kind of ac supply using any of the three meter circuits as an indicator.

The ac power line looked good until Ohm's law sorta caught my attention: 5 amperes at 117 volts calls for an adjustable resistor at a rating of 500 watts or more. So that was out! There's an old adage that says "To cut down on the watts fast, cut down on the volts." On the shelf was a filament transformer offering 12.6 volts at 2 amps, center-tapped. That'd do nicely.

There was one more important thing. I've learned over the years that the pro's won't build a gadget unless it meets two qualifications: one, it must be useful, save time, or do some job that conventional test equipment won't do

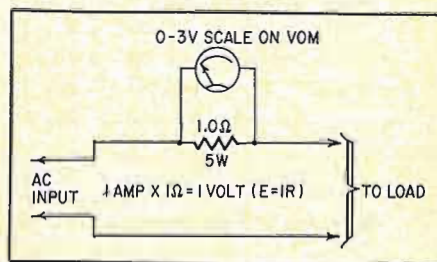

Fig. 1—If you have no ac ammeter, your vom and a 1-ohm resistor will do the job.

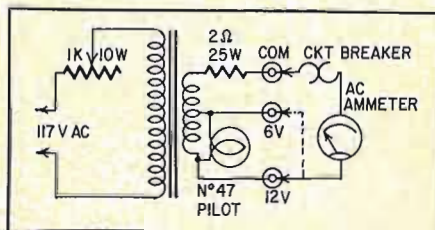

Fig. 2—A much better circuit is the controlled-current supply and ammeter.

(so it makes money!); two, it has to use only standard parts, readily available at all radio-supply houses or off the shelf. No odd-ball values or parts that you have to get out of surplus. This one was built from my own spare-parts stock and junkbox parts.

The haywire prototype proved that the filament transformer would work very well, but I needed an adjustment to vary the current. I had to be able to set the value of hold current and see if the breaker *would* hold and also be able to set the break current to determine if the breaker opened at the specified load current. (Incidentally, the breaker out of that color set was supposed to hold 2.2 amps and break at 3.25 amps. In repeated tests, it kicked out at exactly 2.15 amps. The set's normal measured current was 2.2 amps.)

For the first try, I hooked the breaker directly across the secondary. This worked, but I had control problems. Adding a 2-ohm 25-watt resistor in series with the breaker calmed things down a lot, but the controllable-current problem still had to be solved. First thought was an adjustable resistor in the secondary, but Ohm's law got out of hand again. Five amps at 12 volts is 60 watts, and I'd need a 20–50-ohm pot with a 75-watt rating. That was out.

Well, put the pot in the primary, where the current isn't as high because of the higher voltage. Then the pot won't have to carry all of the primary wattage—most of it will be across the transformer primary. This approach worked. I used a 1,000-ohm 10-watt pot and got the control range I needed.

Fig. 2 shows the schematic of the completed gadget. You can use any kind of current indicator you want because all the box does is furnish the current. I used one of the hot leads as COMMON, the center taps as 6 VOLTS and the other hot lead as 12 VOLTS. Works out in practice like this: You can use the 6-volt range for low-current breakers, say up to 2.5 amps; for the bigger ones, 2.5 to 5 amps, use the 12-volt supply.

You can build this in any kind of case you want. A local tinsmith made the one shown, out of aluminum. You can make it in any shape or add anything you want to it. You can put the 2-ohm resistor inside the case and the meter jacks on it—any way, just so it works! I almost mounted an old crystal socket on top of the case, since it turned out to be an exact fit for the terminals of a new breaker. But, that would have been gilding the lily in a way, so I refrained.

One more thing. You may be wondering why I talk about drawing 5 amps from a 2-amp transformer, eh? Does sound a little rough, but if you consider that the principle of "temporary massive overloading" is used in TV design

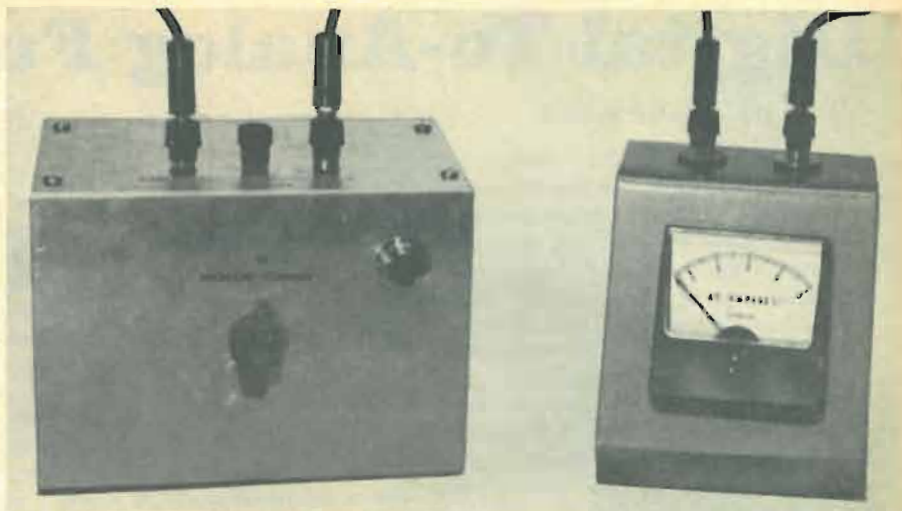

The power-supply box and the ac ammeter are used in series to check breaker operation.

TABLE

Mallory*	Littelfuse	Hold (Amps)	Trip (Amps)
CBT050	815.650	0.325	0.50
		0.490	0.65
CBT075	815.800	0.490	0.75
		0.600	0.80
CBT100	815001	0.650	1.0
		0.930	1.25
CBT150	81501.5	0.975	1.5
		1.0	1.5
CBT175	8151.75	1.14	1.75
		1.2	1.75
CBT200	815002	1.3	2.0
		1.4	2.0
CBT225	8152.25	1.46	2.25
		1.5	2.25
CBT250	81502.5	1.63	2.5
		1.65	2.5
CBT275	8152.75	1.79	2.75
		1.92	2.75
CBT300	815003	1.95	3.0
		2.1	3.0
CBT310	8153.25	2.1	3.1
		2.11	3.25
CBT325	8153.25	2.2	3.25
		2.2	3.5
CBT350	815004	2.44	3.75
		2.5	3.75
CBT375	81504.5	2.6	4.0
		2.92	4.5
CBT400	81504.5	3.0	4.5
		3.25	5.0
CBT450	81504.5	3.9	6.0
		4.14	7.0

*CBT types have twist-tab mounting lugs. Substitute CBB suffix for bushing-type mountings.

Ac ammeter, 0–5, 3-in. case	\$12.70
Meter box	1.47
Power Supply	
Aluminum box, homemade	\$1.00
Filament transformer	2.71
12.6 volts 2 amps	
1,000-ohm pot, 10 watts	3.60
3 banana jacks	1.05
Pilot light, line cord, etc	

to a much greater extent than we generally remember, it's okay. Compute the actual *wattage* of a horizontal output tube during its conduction period, for example. It comes out something like 1,500 watts! The only way the poor little tube can take it is to be pulsed—it carries a simply tremendous overload for just a few microseconds, then they let it rest for a good while.

So, this is what I'm doing, but with slightly longer pulses. We can make tests up to 2–3 minutes at a 100% overload without getting anything too hot. We can thus check 5-amp breakers with a 2-amp transformer and a comparatively small adjusting resistance. In testing the gadget, I let it run for 3 minutes at 4 amps, and it didn't get too hot. Also, our only long-run tests are for hold currents down in the 2–3-amp range. The higher values for checking 3.75-amp units for their break-current levels are needed for only a second or two.

If you're really conservative and happen to have an old TV-type power transformer, use it—the 6-volt winding will probably have a rating as high as 8–10 amps. Use a chunk of iron like that, and it'll sit there all day without getting warm.

The parts we used are shown in the parts list along with their approximate costs. Use any kind of appropriate substitute you want. Surplus is a good source for heavy-duty potentiometers, etc., if you have a nearby store. However, the parts we used are all standard, everyday stock and ought to be available everywhere. The 10-watt 1,000-ohm pot will probably be the most expensive single item.

One last note: You'll find an occasional breaker used in the dc circuits—beyond the rectifiers, instead of in the rectifier input circuits. Test them in the same manner. You'll find they have lower current ratings than the input types, but the action is exactly the same. END

Digital-To-Analog Fundamentals

By IRWIN MATH

IN TODAY'S SOPHISTICATED WORLD OF electronic computers, automatic control systems and complex communication networks, many physical and electrical quantities must be measured and processed with electronics. At present, there are two ways for handling such information—the analog and the digital methods.

When the value of quantities such as temperature, fluid flow and illumination level change, they do so gradually and continuously. To measure such *analog* quantities, certain sensing devices—thermocouples, flow meters, and photocells, for instance—are used. The output of a thermocouple is a continuously varying voltage; there are no jumps or breaks between one point and the next. For example, Fig. 1 is a graph of the temperature variations during a normal summer day, as measured by a thermocouple calibrated in degrees F. Notice that the curve is smooth—all temperatures from the high of the day to the low have been recorded.

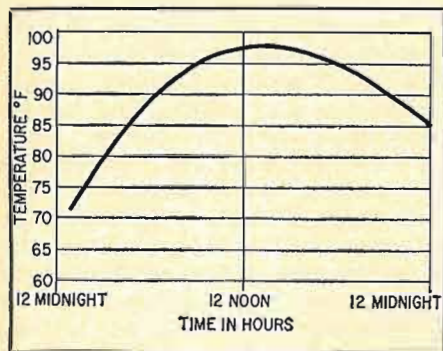

Fig. 1—Temperature on a summer day.

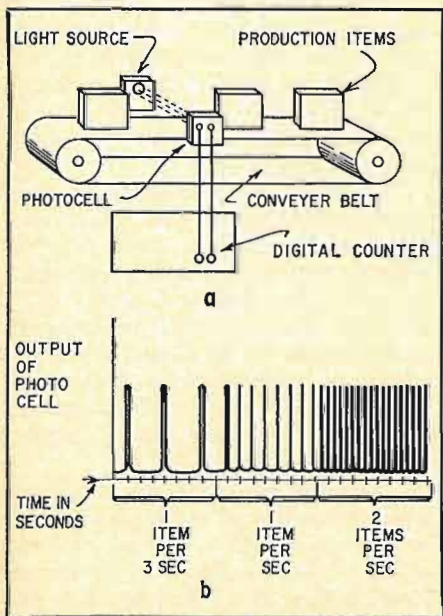

Fig. 2-a—Simple digital counting system. b—The output from the counting system.

Other values—such as the number of boxes on an assembly line or the number of automobiles passing a toll booth—are called *digital* quantities. They are composed of distinct, separate units, never varying continuously but always in discrete steps. The output of digital sensing devices such as electronic counters, proximity detectors or photoelectric relays are usually pulses or steps in voltage. Fig. 2-a shows a high-speed production line with a photoelectric counter, while Fig. 2-b illustrates the output of the photoelectric cell. Every time an object interrupts the light beam, a pulse is produced and the counter is triggered. This output, unlike the analog output, is abrupt. An increase in the number of items passing the photocell increases only pulse rate. Amplitude remains the same.

Digital-pulse information, unlike continuously varying analog data, is more easily processed in electronic devices. Flip-flops can quickly count pulses, digital computers can readily add, subtract, multiply and divide them; and punch cards and magnetic tapes can store them. It is therefore often desirable to convert analog information to digital signals. Many devices have been developed to accomplish this, and if you understand how analog-to-digital converters work, you'll know more about today's industrial measuring and control systems.

As an example, suppose it's desired to keep the temperature of a room at 75°F. Since temperature is an analog quantity, what's needed is a device to sense 75°F, to turn on a heater if the temperature falls or a cooling device if it rises. Fig. 3 shows the system. A bimetallic strip is used as the analog-digital converter. When the temperature is below 75°F, the strip bends up (the analog input) and the heater is connected in the circuit (the digital output). As the temperature rises, the strip slowly bends down until, at exactly 75°F, the contact is broken and the heater turns off. If the temperature should rise above 75°F, the bimetallic strip bends further down and turns on the air conditioner. Now the cycle reverses, the contact being broken when 75°F is reached. By varying the settings of either contact point, various temperatures can be sensed and controlled.

Most analog-to-digital converters are more complex than the previous example. Consider Fig. 4. In this circuit an analog input of 0–10 volts changes the bias on Q1 (an npn transistor), thereby varying emitter-to-collector resistance r_2 . This change in resistance varies the total resistance ($R_1 + r_2$) in the Q2 emitter circuit, altering the number of pulses per second produced by

pulse generator Q2. As a result, each analog change produces a definite change in the number of pulses. Since fractions of a pulse cannot be produced, the output is a true digital signal.

Using this system, analog temperature information can be read out on a numbered display device. A thermocouple's output can be fed to the converter and the resultant pulses used to trigger illuminated numerals.

When an analog quantity has been put in digital form for processing and storing, it's often desirable to recover the information by using a digital-to-analog converter. The automobile tachometer is an example. Engine revolutions—*analog* data—are translated into digital form by the breaker points, which produce pulses used to fire the sparkplugs. A dc meter is used to indicate engine rpm, but the meter can't respond to pulses. It needs a dc voltage, furnished by the circuit of Fig. 5.

An input pulse causes C1 to charge through D1 with indicated polarity. While this happens, D2 is reverse-biased and therefore nonconducting. After the pulse has passed, the voltage on C1 reverse-biases D1 and discharges through

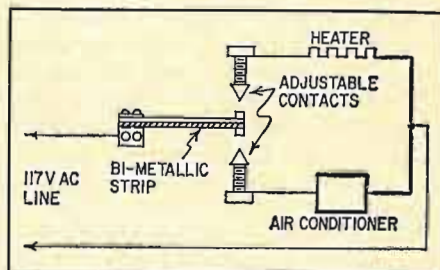

Fig. 3—Simple digital-to-analog converter; temperature controls heating or cooling.

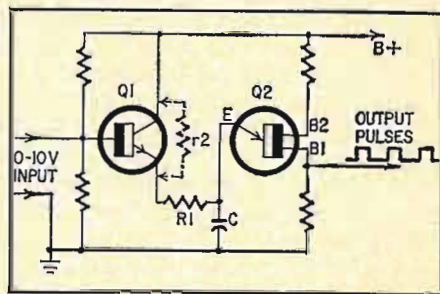

Fig. 4—This is the basic form of an electronic analog-digital conversion system.

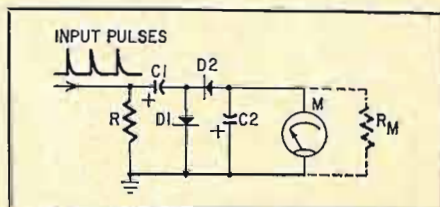

Fig. 5—An automobile tachometer uses one kind of digital-to-analog conversion.

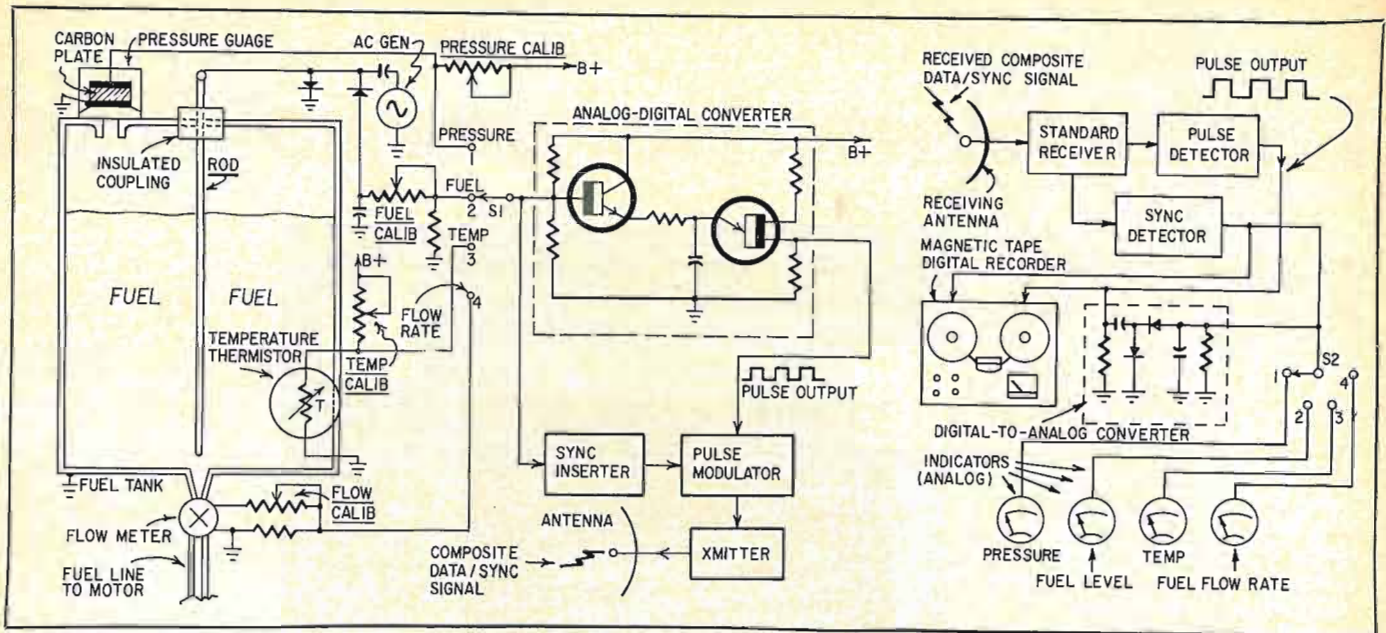

Fig. 6—This rocket-borne telemetry transmitter uses analog-to-digital conversion.

Fig. 7—The rocket-telemetry receiver.

D2 (which is now forward-biased). C2 charges until the voltages across both capacitors are equal. The next input pulse causes exactly the same sequence of events, adding more voltage to C2. But meter resistance R_M is in parallel with, and constantly discharging, C2. As a result, the meter indicates the average voltage across C2. The faster the engine turns, the more pulses per second are fed to the circuit, the more quickly C2 is charged, and the higher the meter reads. Thus meter indication is proportional to engine speed.

The preceding examples are employed in certain simple devices but have limited application in industry and communications. More complex systems, combining several functions, are used extensively for special applications.

Figs. 6 and 7 are simplified diagrams of a telemetry system used to obtain fuel-tank information from a rocket in flight. All values to be measured are analog, so the sensing devices produce continuously varying output voltages, each proportional to the parameter being measured. One important item is the rate of fuel flow. To sample the flow, a paddle wheel in the fuel line drives the armature of a dc generator (Fig. 6). Hence, the dc voltage is proportional to the rate of fuel flow.

It's also desirable to know how much fuel remains in the tank at any time. The task is accomplished with an unusual capacitor. Again referring to Fig. 6, a rod is suspended in the middle of the tank, forming one plate of the capacitor. The walls of the tank form the other plate. The value of this capacitor is determined by the dielectric constant of the liquid (which is known for each fuel type) and by the amount of liquid in the tank.

Since the capacitance is very small,

special techniques must be used to measure any change. The tank capacitor is placed in series with an external fixed-value capacitor, forming a voltage divider. An ac generator places a voltage across this divider so that any change in the value of the tank capacitor changes the ac voltage amplitude. This ac output is rectified to produce a dc voltage for further processing.

Resistive voltage dividers fed by dc sources are used to measure fuel temperature and pressure. One divider contains a thermistor in the tank, monitoring the temperature and varying dc output voltage proportionately. Fuel pressure is measured by a carbon block between two metal plates in another voltage divider. Any increase in tank pressure compresses the carbon material, altering the output voltage.

The output from each sensing device is tapped down to a convenient range for conversion to digital form. It would be desirable to monitor all parameters continuously, but only a single transmitting channel is available: consequently, time multiplexing must be used. Switch S1 connects each sensor output to the converter for a short period, then moves on to the next one.

The analog-to-digital converter operates just like the one shown in Fig. 4. Its pulse output—which is proportional to the quantity being measured—is fed to a pulse modulator. This stage modulates the transmitter of the rocket, which sends the telemetry information to the receiving station. Note the sync inserter—this device adds a sync signal to furnish a reference point for locating the position of switch S1. Thus at the receiver it's possible to determine which quantity is being measured at any time.

Fig. 7 shows how the telemetered information is processed by the receiver.

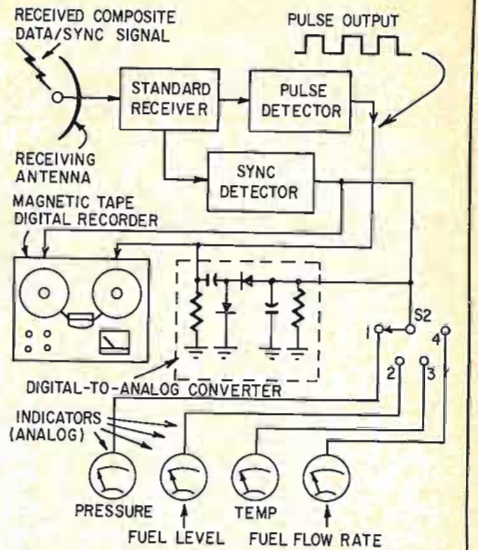

Rf is processed by a conventional method, and a pulse detector recovers the original pulses. These pulses go through the digital-to-analog converter, and the continuously varying dc output is fed to sampler S2, identical to and synchronized with S1 in the rocket. S2 feeds the analog data to the various indicating meters, which are calibrated in gallons per second, pounds per square inch, etc.

For permanent reference, a tape recorder stores the pulse information. At any later time, the tape may be played back and used to drive the converter, S2 and the readout meters.

For greater resolution, sometimes the pulses are fed directly to electronic counters with numerical display readouts. At other times the analog outputs of S2 are fed to oscilloscopes or ink-chart recorders.

The system described in Figs. 6 and 7 is necessarily simplified; most systems are more complicated and sophisticated. However, the same basic principles are employed in both.

There are many other types of converters and sensors—time encoders, shaft-angle decoders and weighted decoders. All accomplish similar tasks. A continuously varying quantity is monitored by a sensor, the information changed to pulses, and these pulses used to control some portion of a production process. For human monitoring of the quantity, the pulses are converted back into continuously varying voltages, where they drive meters.

Digital and analog systems are like two languages. The converters are really translators. They're useful because two different systems can then exchange information. It's a lot like two persons from different countries talking to each other through an interpreter. Without him, there'd be no communication. END

Lucky Hunts Horizontal Hold

The intrepid and youthful benchman chases trouble like an overcontrolled oscillator seeking a 15,750-Hz point in phase with the signal

By WAYNE LEMONS

LUCKY WAS PUZZLED, A NOT UNUSUAL situation. His boss, Cy, was out helping in some civic venture and Lucky was left to find the reason for a "no horizontal hold" complaint. The receiver was a Zenith 16C20 chassis. The picture wouldn't lock within the range of the back-panel control. After pulling the back, Lucky noticed the control was a slug adjustment. By putting out the adjustment knob so that it missed the stop he could turn the slug. Turning it past the stop produced a locked-in picture.

"The boss sure made a boo-boo on this one," he said to himself. "I wish he was here so I could show him."

If Lucky rubbed Aladdin's lamp he could not have had his wish granted more quickly. Cy, stomping the snow off his shoes, plunged through the door. "The committee decided it was a little too blustery to decorate the Christmas tree on the courthouse lawn," he explained before Lucky could ask.

"I can guess who the chairman of that committee was," Lucky grinned.

"I just thought you might need some help with that Zenith."

"Me?" Lucky asked in mock surprise. "Me, the old pro?" He did an elaborate bow and swung his open hand toward the receiver. "Just look at that... that..."

Cy couldn't help laughing at the look of consternation that crossed his young helper's face. The picture on the

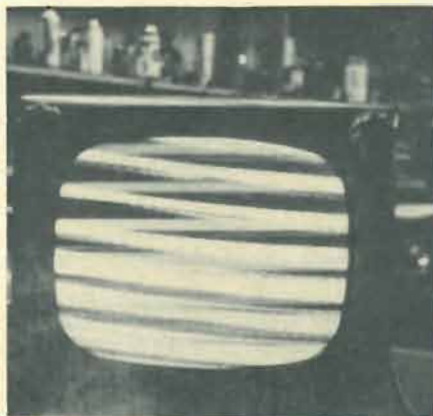

The receiver worked fine until it was switched to another channel. This is what it looked like after switching channels.

set was out of horizontal sync. Lucky dived for the hold control and after some frantic juggling eventually got the picture locked in again.

"Critical, ain't it?" Cy noted.

"A little," Lucky admitted.

"Had to move the hold control past its regular stop to get a picture at all, right?"

"Then . . . then . . ." Lucky began to comprehend, and threw up his hands as if resigned to his fate. "You baited a trap and I put my foot in it as usual. You tried pulling out the knob and turning it past its stop, then you deliberately put it back where it was, just to catch me. When the picture locked in, I

thought the trouble was fixed."

"That's a lesson you have to learn if you ever want to become a good technician. Always check the cause and find the cure if at all possible. Remember that *treating the symptoms doesn't usually cure the disease.*"

"But it seemed to lock in okay," argued Lucky.

"Are you sure? If you had taken the time just to change from one station to another, you'd have seen it wouldn't hold."

"Is that a good way to check horizontal sync?"

"Right," Cy said. "Or you can just switch off channel and back on. Anything to shock the circuits. If the horizontal is working okay the picture should lock in immediately with no slanting bars."

"And if it doesn't?"

"Then try setting the horizontal hold until it will."

"And if that doesn't work?"

"Then dig in and find the trouble." Cy grinned.

"I suppose that's what we have to do here."

"Right," agreed Cy. "I checked the oscillator tube this morning and even replaced it with another one. I did the same to the sync tube, so I'm sure it's circuit trouble. Where's the schematic?"

Lucky didn't answer. He started digging through the service literature files. He came up with the diagram and spread it in front of them. They both studied the circuit of Fig. 1 a minute. "What kind of an oscillator is that?" Lucky asked.

"A Hartley," Cy replied.

"Well; even I know that! What I want to know is how it works?"

"Pretty good. Most Hartley's do."

"You know what I mean," Lucky fumed. "Explain the circuit, the whole circuit and nothing but the circuit."

"Oh," said Cy with feigned innocence. "Well, look at the schematic here. The control circuit uses these two diodes and the triode half of the 6EA8 as a reactance tube. The oscillator..."

"Looks like an electron-coupled job," Lucky interrupted.

"It is, with a slight difference from the run-of-the-mill eco."

"What's that?"

"Well, as you know a Hartley puts out a sine wave."

"And they don't use sine waves to drive sweep circuits."

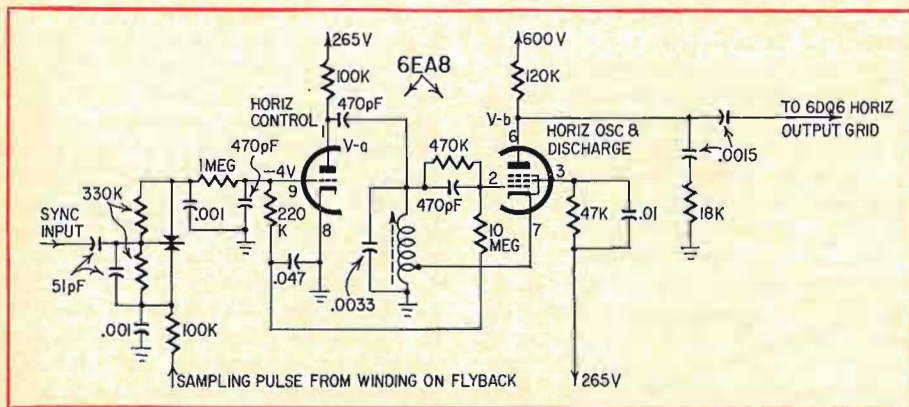

Fig. 1—Heart of the problem, Lucky found, wasn't in the tubes, but the circuit of the horizontal oscillator and control of this Zenith 16C20 chassis. Can you find the trouble?

"Bravo," said Cy, "maybe some of that fog in your head is clearing away after all. How do you suppose they get the modified sawtooth then?"

"From the plate circuit?"

"Right. Zenith calls this section of the tube a *horizontal oscillator and discharge*, as you can see. The .0015 capacitor and the 18K resistor in series make up the discharge or wave-shaping network in the plate circuit.

"I see that, I think, but what about the control part of the circuit? That must be where our trouble is."

"You're probably right," agreed Cy. "You savvy how the diodes work, right?"

"Well, at least I know that they put out a negative or positive voltage depending on whether the oscillator is high or low in frequency as compared to the sync pulse."

"That's true," said Cy. "In this circuit, the control voltage is then fed to the grid of the *horizontal control tube*."

"Then the control tube amplifies the control voltage?"

"Well, yes and no. There is amplification and it is utilized, but you see this tube isn't dc-coupled to the oscillator as in some circuits. And it does make a difference, you see."

"I see that," said Lucky. "There is a 470- μ F coupling capacitor from the plate circuit to the oscillator coil, though."

"Right. And that puts the control tube right across the oscillator coil in series with that 470 μ F. See that? Now what happens if we change the bias on the grid of the control tube?"

"That will put more or less capacitance across the oscillator coil because the tube will act as a variable resistance in series with the 470 μ F across the oscillator coil."

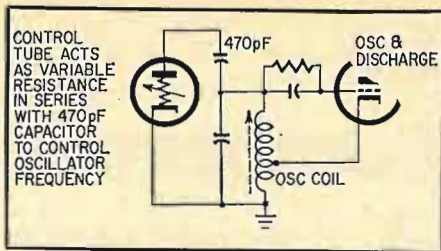

Fig. 2—Control tube rides gain on oscillator by varying its plate resistance.

"That's a good simple explanation. Though it may not exactly fit reactance-tube theory, it's close enough for servicing purposes. Does all this give you any idea of how to find the trouble we got?"

"I've just been thinking . . . diode phase detectors give a lot of trouble. Why don't we replace 'em and see if that doesn't do it?"

"I give up," lamented Cy. "No matter how hard I try to get you to think before acting, you insist on doing just the opposite."

"But diodes do give a lot of trouble," protested Lucky.

"Sure, and so do sync and oscillator tubes, and resistors and capacitors, but replacing everything in sight isn't the best way to repair TV."

"We can check them without pulling them," Lucky insisted.

"Okay, let's check 'em if it'll make you happy."

Cy picked up the ohmmeter probes and set the scale to R \times 100. He measured each diode section separately in the forward and reverse direction. Both sections were almost identical and with good forward-to-reverse ratio.

"That satisfy you?" Cy asked.

"I reckon they're okay; at least they appear to be."

Cy tacked back in the center termi-

nal that he had disconnected for the test. "Now maybe we can get down to business. Let's see if we can't find out if the control tube is working."

"How can we do that?"

"I was just thinking, remember how you explained the reactance-tube control circuit? Okay, that means if we change the grid bias on the tube we should be able to change the oscillator frequency, right?"

"Right, so what do we do, get out the bias box?"

"Nothing so sophisticated as that."

Cy grinned, "Although, I must congratulate that tremor in your gray matter. We can just ground the grid of the control tube. It has about 4 volts negative on it now, so grounding it will raise the grid bias 4 volts."

"That'll make the tube conduct like crazy."

"You said it, and the plate voltage should drop. You get the jumper and I'll connect the voltmeter to the plate."

Lucky grounded the grid. The plate voltage dropped sharply but there was virtually no change in the oscillator frequency.

"Eureka," shouted Lucky. "I know just how Archimedes felt when he sat in the bathtub."

"Well, good," said Cy. "Replace the defective component—I'm going to chow."

"You bet," said Lucky. "I suspected that little 470- μ F capacitor we were talking about all along."

"I know you did," agreed Cy as he buttoned his coat and walked out. "I know you did, along with every other component in the set."

Lucky started to reply but Cy was already out of earshot. After Lucky thought it over, he decided there hadn't been much to say anyhow. END

WHAT'S YOUR EQ?

Conducted by E. D. CLARK

Zener Limiting Circuit

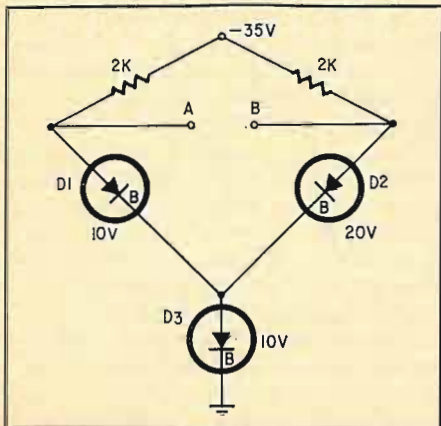

Three Zener diodes, each rated at $\frac{3}{4}$ watt, are connected as shown to expand a voltmeter scale. What's the voltage between A and B?—Kendall Collins

Two puzzlers for the student, theoretician and practical man. Simple? Double-check your answers before you say you've solved them. If you have an interesting or unusual puzzle (with an answer) send it to us. We will pay \$10 for each one accepted. We're especially interested in service stinkers or engineering stumbers on actual electronic equipment. We get so many letters we can't answer individual ones, but we'll print the more interesting solutions—ones the original authors never thought of.

Write EQ Editor, Radio-Electronics, 154 West 14th Street, New York, N. Y. 10011.

Answers to this month's puzzles are on page 91.

Voltage Problem

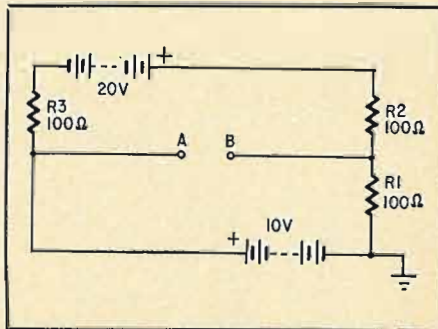

What's the voltage between A and B?—John A. Reeder, Jr. END

FUEL CELLS— Power for Tomorrow

Electricity from chemical power packages

By ALLEN B. SMITH

THE RECENT ANNOUNCEMENT BY FORD Motor Co. of a significant development in chemically produced electricity is one more step in an industry-wide effort to develop self-contained, efficient and economical sources of clean power. Spurred on by Government projects for spacecraft power, industrial quests for new products and private concern over air poisoning, the fuel cell is enjoying new popularity in labs across the nation.

Just what are fuel cells? How are they constructed, and are they as efficient as other sources of energy? Is there a future for chemically generated electricity? If so, where does that future lie?

For years, researchers have known

the answers to all but the last question. But a lot of us are still pretty much in the dark about the what's, why's and how's of the fuel cell, in spite of the fact that as early as 1839 an Englishman named Sir William Grove outlined its theory of operation. Nearly 100 years later, in 1932, another Englishman, an engineer named Francis T. Bacon, put Grove's theory to work and began developing practical cells of high efficiency. Since that time, the fuel cell has progressed from obscure lab-curiosity research to the crash-development program that has caught the attention of the entire technological community—and the general public.



One of the Gemini fuel-cell units in fully encased form, as a single cell (at far left), and as a cell-stack module—one of three such modules making up the complete system.

Before we speculate on the return of electric cars and other vehicles, on fuel-cell-powered space stations, on lightweight portable military power packs, or on homes in which all energy comes from their own private source, let's find out just what we're talking about.

The fuel cell resembles an ordinary battery in many ways; its main difference is that it doesn't require recharging. When the chemicals that make up the fuel cell react, free electrons are liberated, and a voltage is developed between the cell's two electrodes. All that is necessary to sustain this voltage—and the resulting current flow—is a continuing supply of the chemicals.

Another startling fact is that fuel-cell efficiencies theoretically approach 100% (present cells attain nearly 75%) as opposed to efficiencies of 40% for modern steam generating plants and 25–35% for gasoline and diesel engines. These characteristics give a strong indication of what all the excitement is about.

Basic fuel-cell theory

In principle, any reduction/oxidation chemical reaction can develop measurable electrical outputs. Even the most highly developed fuel cells employ hydrogen and oxygen, generally in their gaseous states. Both elements are easily available, and their only byproduct is pure water. Potassium hydroxide is the most common cell electrolyte, although acid electrolytes may be used. This type of cell is quite basic, and lends itself well to explanation of the chemical process involved.

The action of a fuel cell is often described, although not absolutely accurately, as the inverse of simple electrolysis of water. In electrolysis, as you may recall from your experiments in school, a voltage is applied to electrodes immersed in water made conductive by adding common table salt. Current flows, and electrolytic action produces pure oxygen and—within the solution of water and salt—hydrogen ions and hydroxide ions. Much hydrogen is produced commercially in this manner.

In the fuel cell diagrammed in Fig. 1, hydrogen is fed under slight pressure to the fuel electrode (anode). Individual hydrogen molecules pass through the anode to collect and combine with hydroxide ions. A catalyst (usually platinum) on the electrode speeds the reaction and the release of electrons. Free electrons on the surface pass into the electrode and are conducted up through it and through the external load to the oxidant electrode (cathode).

Oxygen fed to the cathode under pressure is broken down in the electrode, and oxygen molecules collect on the electrode surface exposed to the electro-

lyte. There, the oxygen combines with water and with the electrons which have flowed from the load circuit, producing hydroxide ions. These ions migrate to the fuel electrode, completing the circuit chemically and electrically. Output of typical hydrogen/oxygen cells ranges between 50 and 200 amps at 0.7 to 0.8 volt/sq ft of the cell area.

The simple cell doesn't tell the entire story of fuel-cell chemistry or system operation. With research activity quickening, diverse techniques have been developed. Various fuel/oxidant combinations, electrolyte compounds, methods of containing the electrolyte, operating temperatures and pressure systems are all covered by the fuel-cell label.

Low-temperature cells

The largest group—and by far the most successful to this point—consists of the hydrogen/oxygen (hydrox), hydrogen/air (hydrair), and some alcohol/air cells, all of which operate at fairly low temperatures, generally under 100°C. Some secure their fuel and oxidant gases from pressurized containers; others, notably the cells developed for space vehicles, use cryogenically stored liquid hydrogen and liquid oxygen (LOX).

Still other types of hydrox cells employ, as part of the complete power system, self-contained generators of hydrogen and oxygen. One such system, a 5-kW indirect hydrocarbon/air system developed for the Army's Engineering Research and Development Labs (ERDL) by Allis-Chalmers Mfg. Co., operates as a standard hydrox cell stack. It has a hydrogen generator that extracts the gas from liquid-hydrocarbon fuels such as JP-4, kerosene or JP-125 jet-engine fuels. Pure hydrogen is formed by combining the liquid fuel with water in the presence of a reforming catalyst; the gas is extracted through a palladium-alloy diffuser.

The generator can produce 140 cu ft/hr at 1 psi. Oxygen is formed by compressing environmental air and removing the carbon dioxide. CO₂ can form destructive potassium carbonate in the cell stack, in reaction with the potassium-hydroxide electrolyte.

A significant variation from the liquid electrolyte used in most hydrox cells is the solid-polymeric ion-exchange-membrane electrolyte (Fig. 2). This plastic-electrolyte cell, developed by General Electric Co., is used in the 28-volt power package of Gemini spacecraft fuel cells. The ion-exchange membrane is a thin sheet of polymer plastic sandwiched tightly between two tantalum electrodes (which use finely divided platinum as a catalyst). The molecular structure of the plastic elec-

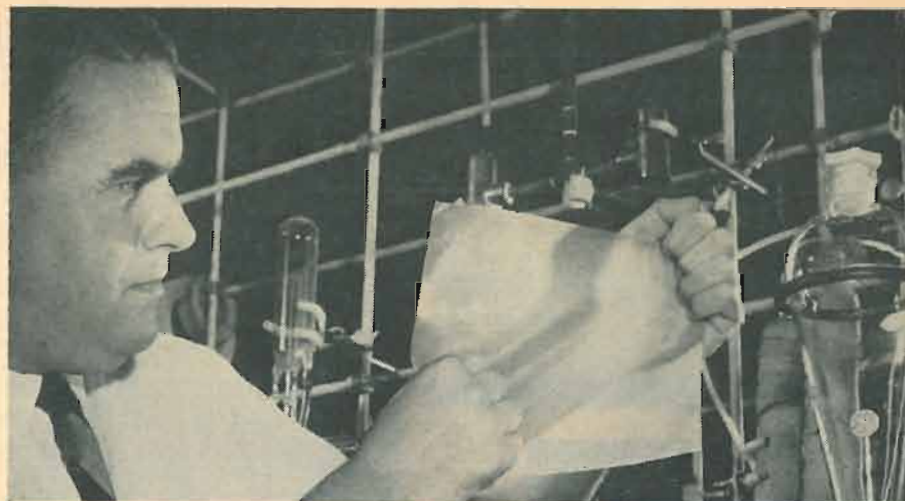

Engineer displays sheet of polymeric material used as ion-exchange electrolyte in Gemini.

trolyte permits the exchange of hydrogen ions between the electrodes. Each electrode forms one wall of a closed chamber on its side of the cell—the anode in the hydrogen chamber, and the cathode in the oxygen chamber. The entire cell measures about 7 × 8 inches.

Hydrogen and oxygen are applied under slight pressure to their respective chambers. In the presence of catalytic electrodes, the cell reaction begins immediately. Hydrogen atoms give up one electron each, forming ions that migrate through the polymeric electrolyte to the cathode, combining with the oxidant to produce water. The free electrons are collected at the anode and, after passing through the external load, flow back into the cell at the cathode.

On the oxygen side of the cell are fabric wicks that absorb the byproduct water and carry it off by capillary action. Oxygen is kept from escaping with the water by a differential-pressure wa-

ter-separation system. The ion-exchange-membrane cell delivers a voltage of 0.73 to 0.9 at power levels of 73 watts/sq ft (100 amps). Efficiencies run in the neighborhood of 55% to 60%.

In the Gemini, the fuel-cell power source consists of 32 cells series-connected into modules, with three modules paralleled to provide a capacity of 1 kW. The complete system, exclusive of the fuel and oxidant sources located within the spacecraft, weighs 135 lb. Two complete systems provide backup and reserve capacity.

Union Carbide Corp. has developed straightforward hydrox cells for the Army, put together as a 28-volt power source to operate radar and communications equipment. Each cell uses porous-carbon electrodes with platinum as a catalytic agent; hydrogen and oxygen are supplied from pressurized cylinders.

Among other low-temperature cells are the methanol/air cell (Esso Re-

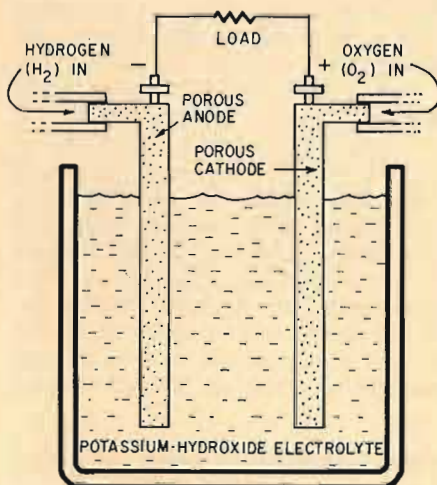

Fig. 1

Fig. 1—The simplest form of fuel cell.

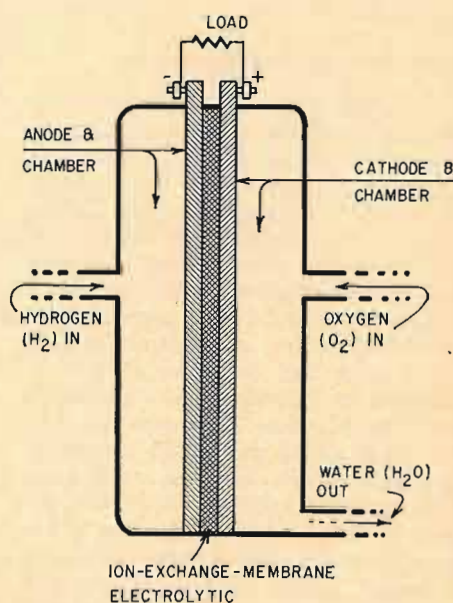
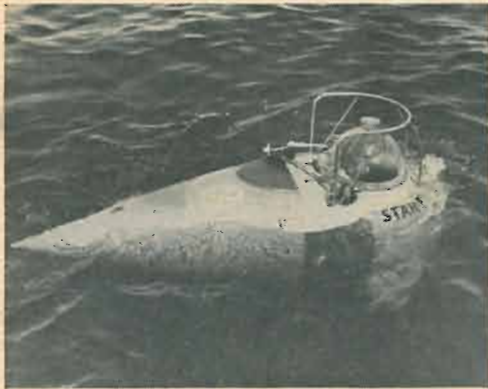

Fig. 2

Fig. 2—Dry-membrane cell has operated as long as 4,000 hours continuously.



Surprising variety of fuel-cell-powered vehicles already have been designed, built, and tested by one of the major research groups active in American basic fuel-cell development. Clockwise from upper left, a one-man submarine, two-man golf cart, 2,000-lb-capacity lift truck, and earliest fuel-cell vehicle to be developed—a tractor with 3,000 lb of pull.

search & Engineering Co.) which uses sulfuric acid as the electrolyte, and the direct propane/air cell that uses very expensive platinum electrodes and a phosphoric-acid electrolyte. Still in early stages of development, these latter two techniques have not as yet been fully evaluated.

Medium-temperature cells

In this category, the outstanding techniques and hardware items are those descended directly from the 1932 experiments of Dr. Francis T. Bacon. Pratt & Whitney Aircraft, Div. of United Aircraft, has modified the Bacon-type cell—basically, a hydrox cell with fuel and oxidant supplied at elevated pressures—to operate with a potassium-hydroxide electrolyte at temperatures near 200°C with fuel pressures of 1 to 5 atmospheres. Under these conditions, the cells produce 250 amps at 0.85 volt/sq ft, giving about 70% efficiency. The pure nickel electrodes contain no precious-metal catalysts. They rely instead on the elevated temperature of the electrolyte to provide the increased molecular action that ensures rapid chemical reaction. This cell is the one being readied for use in NASA's Apollo

spacecraft development program.

Also in the moderate-temperature category are most of the cells using liquid and gas hydrocarbon fuels with some form of oxidation or reforming system to break the basic fuel into useful hydrogen gas. Several types of cells use palladium/silver membranes, which are permeable only to hydrogen, to extract hydrogen directly from hydrocarbon fuels. They operate at 350° to 450°C. The exchange of ions through the membrane into the potassium-hydroxide electrolyte is speeded by nickel-screen catalysts and superheated steam. In most of these cells, plain air is the oxidant, rather than pure oxygen. Leesona Moos Labs, Pratt & Whitney Co., Westinghouse Research Labs, and General Electric Co. all are testing several electrode materials and configurations, as well as complete hydrocarbon/air fuel-cell systems.

High-temperature cells

The use of molten-carbonate electrolytes in voltage-producing cells has been investigated by researchers at Texas Instruments, Inc. and at the Institute of Gas Technology in Chicago. This family of fuel cells has many at-

tractive characteristics, including low cost, silence, high efficiency and adaptability to various fuels.

Typical of this class of cells is one under development at the Institute of Gas Technology, which uses as the electrolyte a mixture of two or three alkali-metal carbonates and an inert-metal oxide. The electrolyte compounds are prepared and mixed initially in powdered form, then hot-pressed into disks at pressures of 8,000 psi and temperatures of 950°F. During operation, cell temperatures are held at 1,000° to 1,100°F, either by action of the process itself or by external heat. At this elevated temperature, the electrolyte melts. The molten electrolyte is held between a silver-film cathode about 10 microns thick and a porous-fiber nickel anode.

Fuel for the cell is natural gas, processed by steam reforming in the presence of a catalyst to release hydrogen; the oxidant is ordinary air. Efficiency of this cell depends on a variety of factors, but primarily on the efficiency of the external hydrogen reformer and the rate at which oxygen from the air is combined in the reaction. Overall efficiencies range from 40% to 43% with cell potentials of 0.7 to 0.9 volt.

Where from here?

It should be clear by now that much of what you have read so far in this article and in others has concerned primarily the development of fuel-cell devices. To be sure, there are practical units in operation, but they are primarily in high-budget NASA or Air Force spacecraft projects. None of the existing systems can be regarded as commercially feasible at this stage of development. In spite of this, potential fuel-cell applications don't seem to have been exaggerated.

There are several commercial uses for which fuel-cell power is being considered: industrial, especially in metallurgical processes; vehicular drive systems; portable power for electrical and electronic equipment; and energy centers for homes. Of these, vehicular and portable power seem most likely to offer specific advantages over present means.

As long ago as October 1959, Allis-Chalmers' research division demonstrated a fuel-cell-powered tractor capable of exerting a 3,000-lb drawbar pull. The power unit was a hydro-cell matrix generating 15 kW. Since that time, the same company has demonstrated vehicles using hydrox, ammonia/oxygen, and hydrazine/oxygen fuel-cell packages. Among these have been a fork-lift truck with 4,000-lb capacity, a two-man golf cart, a lightweight forklift truck of 2,000-lb capacity, and other related vehicles.

Under contract to General Dy-

namics' Electric Boat Div., A-C also designed and assembled a 36-volt system to supply 750 watts of power for the electric drive motors of a one-man underwater research vessel, the first practical application of fuel-cell motive power. The craft (RADIO-ELECTRONICS, August 1966, page 32) used a power pack supplied by liquid hydrazine-hydrate fuel and gaseous oxygen under pressure in rapidly rechargeable cylinders. Fifty individual cells made up the series-connected module. It had output taps at 12 volts for communications equipment and 24 volts for vehicle subsystems, and used the full 36 volts for the main propulsion motors. Individual cells produced 250 amps/sq ft at a voltage of 0.75.

Fuel-cell power for cars?

The question of whether fuel-cell systems will power cars, motorcycles and boats of the future hasn't been fully resolved. The odds are strongly in favor of the affirmative. It's no secret that major automotive research labs in the US and Europe are working toward fuel-cell power packages for small-sized personal vehicles for use primarily in metropolitan areas.

Ford's liquid-sodium/sulphur rechargeable battery, mentioned at the start of this article, is not a fuel cell using

expendable chemical components; but it does represent a significant development in compact, lightweight electrical sources that can deliver the high-current demands of an automobile drive motor. Strictly a rechargeable battery, Ford's device uses techniques developed in fuel-cell research. It probably is an interim step in the development of an actual fuel-cell power pack.

The Ford cell employs liquid sulphur as the anodic element, a ceramic electrolyte that is permeable only to migrating sodium ions, and a liquid-sodium cathodic element. In developing electricity, the sodium atoms give up electrons to the external circuit through the cathode. The resulting sodium ions pass through the ceramic electrolyte to form sodium sulfide in reaction with the sulphur and the free electrons returning from the load through the anode. Recharging is with a 117-volt rectifier/charger.

Ford spokesmen report that within 2 years it will be possible to construct a 1-kW unit weighing about 100 lb. This power source could drive a 1,100-lb vehicle carrying two adults and two small children at 40-50 mph up to 200 miles. Prototypes are now being constructed and tested in England.

Why all the hue and cry for electric cars? Probably, the growing realization

that our cities are being poisoned by the hydrocarbon byproducts of gasoline- and diesel-engine exhausts. Legislators and private citizens alike are pressing for solutions and for action. Since a fuel-cell-powered car would create no byproduct but pure water, the fascination is obvious. Additional advantages of electric vehicles are silence (noise levels in metropolitan centers cause widespread concern), rapid acceleration to cope with city traffic, and greater efficiency.

In spite of these advantages, fuel-cell technology still has a long way to go before manufacturing costs reach acceptable levels. At this point, it appears that 10 or more years will pass before you can buy an electric car. Don't, however, underestimate the extraordinary achievement of which American ingenuity is capable when supplied with a vigorous flow of the long green for intensive research on a broad scale. And keep an eye on that ever-darkening yellowish-brown cloud over your cities; that cloud may be the catalyst that will speed fuel-cell power into your life. Unless an unforeseen breakthrough occurs in the development of lightweight, low-energy nuclear-power sources, the fuel cell in various forms is destined to become a familiar power source of the future. END

HI-FI, HI-FI, ALL AROUND THE HOUSE

How to have stereo speakers, volume controls and on-off switches in every room

EVER WISH YOU COULD HAVE STEREO IN your bedroom? Fine—but what do you do when you're in the living room? It's expensive to have a separate installation in each bedroom, and moving a large system is out of the question. And what if you've got several bedrooms full of people who might want to listen at the same time? You might also want music in a playroom or patio.

The solution—which is nothing new—is to install speakers in each room, using separate volume controls for each speaker pair. One problem remains: Who wants to get up late at night, after



Heart of system is in the living room.

listening to dreamy music, and walk downstairs to turn off the power?

A clever technique was used to overcome this problem in one of the neatest jobs we've seen. It's a six-station stereo installation at the home of Sheldon J. Tannen, Westhampton, N. Y. It was installed by George Nicola, of Atlantic Hi-Fi & TV, Moriches, N. Y.

Fig. 1 shows the wiring of the left-channel speaker bus. All but one of the speakers are in series with L-pads (Centralab WL-8) to permit individual volume control. The monitor speaker is in the living room by the amplifier. Note

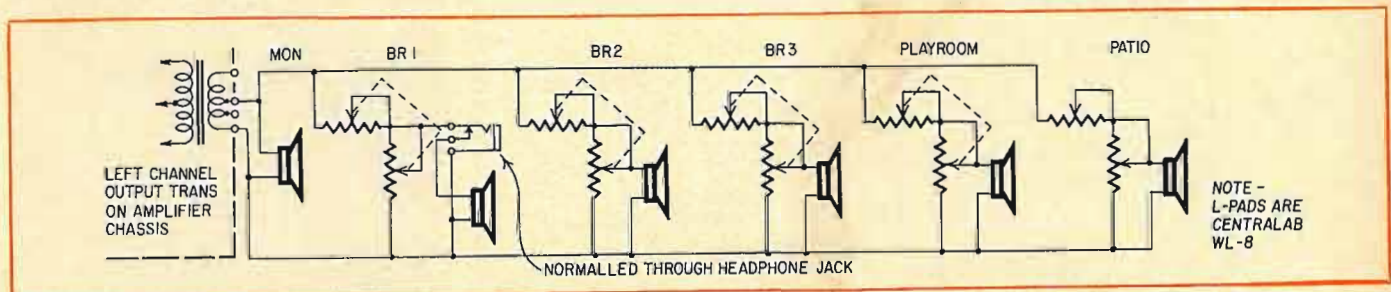
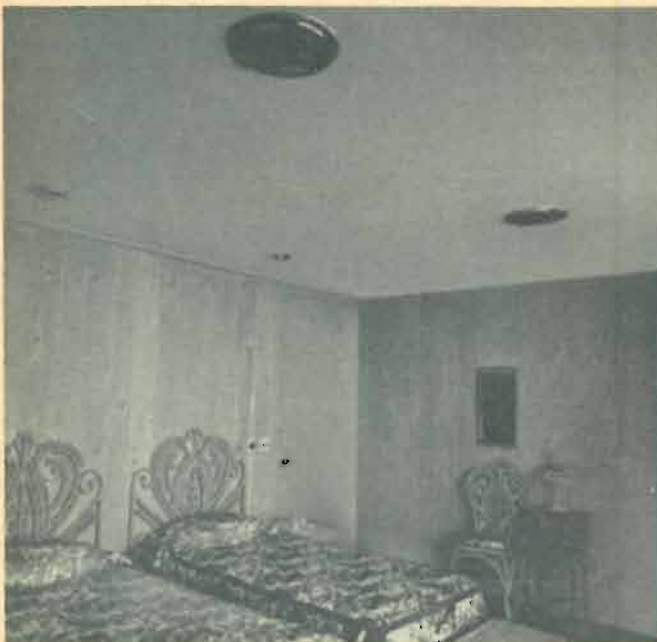

Fig. 1—Wiring diagram of left-channel speaker bus which runs from room to room throughout house.



One of the bedrooms, showing ceiling speakers and wall controls.



Top two antennas are TV, Yagi at bottom is for stereo FM.

that Bedroom 1 has an extra component—a closed-circuit phone jack. Most of the time the speaker is used, but if one person in the bedroom wants to listen to music while the other's asleep, the phones are plugged in, muting the speaker simultaneously.

Of course, the wiring of each channel is identical to that of the other, and the right-channel L-pads and jacks are ganged with those in the left channel.

Heart of the system is a Fisher 400 FM-Mx stereo receiver, preamplifier and power amplifier, together with a tape cartridge machine (see photo). The 10-element FM yagi mounted on the chimney is aimed toward New York City. The lead-in is 300-ohm marine-grade stuff, for long life under salt spray. (The house is at the water's edge, on an inlet from Long Island Sound.)

Amplifier speaker output is fed between the house walls at 8 ohms im-

pedance, since speaker runs aren't long.

What makes this installation different from others is the ability to turn the system power on and off at each remote station. Furthermore, only three-conductor wiring is used between remote switches, and all switches are in parallel. Fig. 2 illustrates the remote switching. The relay is a split-coil type used in residential wiring for remote control of nearly any small appliance. The relays are available with various contact ratings, to handle light- or heavy-current loads.

Each remote switch is a three-position spring-return type, with a normal-center position. When a remote switch is thrown to the ON position, the relay ON coil snaps the contacts together, connecting the ac line to the amplifier power transformer. The remote switch returns to center (off) but the ON coil in the relay latches. When a re-

mute switch is then thrown to the OFF position, the relay OFF coil snaps the contacts open, breaking the ac circuit to the amplifier power transformer. The OFF coil also latches, and again the remote switch returns to the center (off) position.

There is at least one particular convenience to the system. Suppose A and B are each listening to stereo late one night, but in separate bedrooms. When A is ready to go to sleep, he turns down his volume control and uses his remote switch to turn off the ac. But B wishes to listen a while longer. When the ac to the amplifier goes off, he simply turns it back on again.

The speakers are flush-mounted in either the walls or ceilings in the bedrooms and playroom. The patio speakers are Atlas outdoor trumpets and the living-room speakers are Scott bookshelf models. END

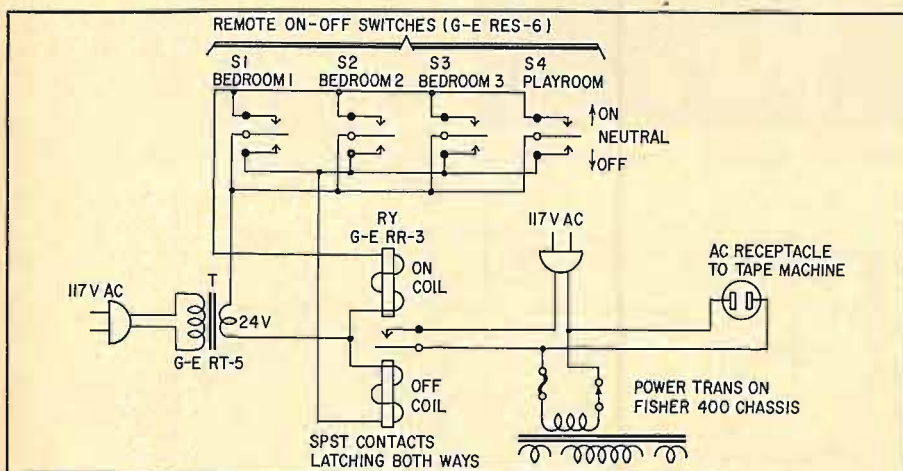
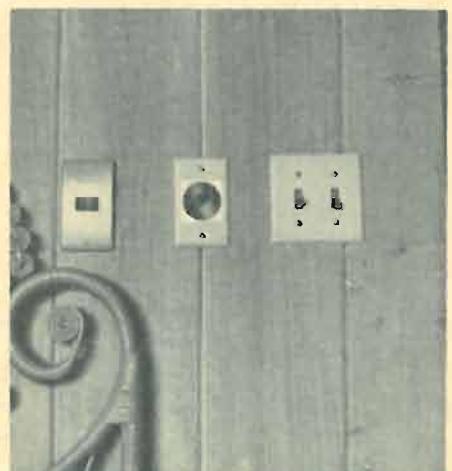

Fig. 2—This control diagram shows the secret of how the remote on-off switches work.



On-off, volume, and room light controls.

coordinates the production typing and printing of his writing efforts. His electronics training and experience are valuable when he is writing alignment, calibration or troubleshooting procedures.

Jim has worked on three large training devices since he joined Honeywell in 1961. Two of them were Fleet Ballistic Missile (FBM) submarine attack trainers; one at New London, Conn., and the other at Charleston, S.C. His most recent assignment has been to write the handbooks and training course materials for an Anti-Submarine Warfare (ASW) Helicopter trainer installed at San Diego, Calif.

In addition to writing handbooks for training systems, Jim also works on proposals for new contracts, and edits and publishes engineering reports.

"What has been your most interesting assignment as a technical writer?" I asked.

"The New London FBM submarine attack trainer. It was so complex it presented quite a challenge. I had worked on a fairly large system with Burroughs Corp. as a field-service technician, but that had been vacuum-tube data-processing equipment. The New London trainer was all solid-state. It also had many types of subsystems: analog, digital, optical, etc. It was quite an experience; I enjoyed it."

"Do you think a technical writer gets to learn more about a system than the technician who maintains it?" I asked.

"There's no question about it. As a technician, I think, just a general knowledge will take you a long way toward fixing troubles in a system. The writer, on the other hand, has to dig more deeply into the individual components of a system and gain a much more thorough understanding of system operation before he can write a book about the equipment, telling in detail how the equipment works and how to fix it. The system knowledge you have to gain as a technical writer would, if you were a technician, make you a top-flight worker on that system."

"What part of technical writing do you find most interesting?"

"The researching, the process of finding out what makes the system work. When you're faced with learning the details of a complex system, there is a real challenge. This is probably the thing that appeals to most writers with a technical background. In essence, it's finding out how the system works and then getting it into words. Then, of course, you have the satisfaction of seeing your words in print and knowing you have put out a manual that may help somebody out in the field, maybe a technician like you used to be."

"Along this same line, what do you think is the least interesting part of technical writing?" I asked.

"Oh, the somewhat dull, but important mechanical chores that have to be done to get a document out. But that is really only a small percentage of the total job. Things can get pretty hectic as you try to meet a deadline and still stay within costs."

By mechanical chores, Jim means all the things that must be done after a manuscript is written to get it ready for publication as a printed document. This represents: (1) preparing a list of illustrations and deciding how much of a printed page each illustration will require; (2) checking that all paragraphs are numbered correctly and that all paragraph references are correct; (3) checking all illustrations and tables against the text to make sure they are referenced correctly, and (4) making up a dummy book showing the layout of written material with respect to tables and illustrations.

"You mentioned earlier that when you left field service you were looking for an eight-to-five job. Have you found technical writing to be this kind of work?" I asked.

"Well, it hasn't been entirely that way. There has been a fair amount of overtime to meet deadlines, so it hasn't always been an eight-to-five job. Also, I had to go back to New London to work on one project and spent almost 5 months there rewriting and verifying publications. Even so, I think I did achieve the main thing I was after, to settle down in a community and live a rather stable life."

"Do you feel there is room for more qualified technical writers?" I asked.

Jim laughed. "Yes! Generally speaking, it's very hard to get qualified people. I suppose this is true in any occupation, but it's especially true in technical writing."

"What is a good technical writer?" I asked.

"The best is a qualified writer with a good technical background. There are certain things in technical writing that a skilled nontechnical writer can handle. But for the most part, I think the writer who has been a field-service or maintenance technician makes the best technical writer."

"What about college training? Are there any courses you could recommend for the beginning technical writer or the technician wishing to change over to technical writing?" I asked.

"Yes, I think such a person would have an advantage if he would take some courses in English grammar, mathematics, basic writing and, of course, basic and advanced electronics to keep him up to date on the latest in electronic devices. I started out as a trainee and learned on the job, even though I have no college training."

"Do you use mathematics much in your job?" I asked.

"Actually, in my day-to-day work, I don't use math very much. But there are times when a mathematics background would be of value. For example: In my present assignment on the ASW helicopter trainer, I needed a background in trig to fully understand system operation. Fortunately, I had a course in trig several years ago, but I had to bone up on it."

"Have you found the chance for recognition is better for the technical writer than for the technician?" I asked.

"Yes, as a technician you are more or less relegated to the background and your work is not always recognized as yours. As a writer you have the opportunity to be in the limelight. If your work is good, you are definitely recognized. Of course, if your work is bad, you are also recognized. I think this gives you a lot more incentive to put more effort into your job. I know I've never had quite the same feeling about any other occupation so far as trying to do my best. I knew individual recognition was there if I was willing to work for it."

"Didn't you win a company award

Writing is hard work, but the returns are worth your best effort. Test yourself. Do you have:

- (1) A reasonable degree of intelligence? Yes No
- (2) Natural curiosity? Yes No
- (3) An understanding of the importance of detail? Yes No
- (4) The ability to grow and take on increasingly difficult assignments? Yes No
- (5) An internal discipline that will keep you working on long-term assignments without close supervision? Yes No
- (6) A good technical background or the willingness to study to get one? Yes No
- (7) The ability to get along with people? Yes No
- (8) The ability to take a group of seemingly unrelated facts and organize them to gain an overall picture of how something works? Yes No
- (9) The desire to move ahead in your technical field with a chance to prove your capabilities? Yes No

If your answers are yes to all or most of the above questions, then you may find technical writing is a change worth considering.

for your work at New London?" I asked.

Jim laughed. "Yes, the company held this *Put Yourself in the Customer's Shoes* contest. Those who the company felt had contributed to successful relations with our customers were awarded a pair of Hush Puppies. I was lucky."

Jim is typical of many technical writers presently working in industry. Writers with practical technical experience make the best writers of maintenance and operation manuals because they have a feel for what information the technician or mechanic needs. Jim is an example of how a technician with a desire to get ahead can do so in technical writing—even without college training.

College training is important, although it may not be a specific requirement. The ideal technical writer, of which there are very few, has a B.A. degree in physics or a B.S. degree in engi-

neering with a master's degree in creative writing, English or journalism. Many of the technical writers working in industry do have college degrees, but few meet the requirements for the ideal technical writer.

Many technical writing groups do original writing from their own research, as do Jim and other writers at Honeywell. In other organizations, the technical writer is really an editor, in that he edits, organizes and publishes material written by engineers. This technical editor generally has to have more formal college training in English, but doesn't need as much technical training.

Some technical writers, like Jim, work in industrial organizations. Others work for government agencies, national news magazines, and technical magazines. There are also free-lance technical writers who write articles for the various trade and technical magazines. The free-

lance market is the most difficult to enter because it requires a great deal of study and contacts with editors and public relations men.

For the person desiring some of the freedom of the free-lance writer, there are companies specializing in technical publications who send writers to companies on contract for periods of a few days to several months. These operations are similar to the Kelly-girl service for stenographic help. Writers working on a contract basis are normally referred to as *job-shop writers*. Such persons earn higher hourly pay than a regular salaried writer, but they enjoy less job security. I might add, however, that the *good* job-shop writer is seldom out of work. In September 1964, I asked one of these fellows why he worked only 32 hours a week. His answer: "I earn \$5.50 per hour and besides, I've already made \$10,000 this year." END

Need A Power Resistor? Try A Transistor

Put orphan transistor to work

By CLEMENT S. PEPPER

HAVE YOU DUG THROUGH YOUR JUNKBOX lately in a fruitless search for a much-needed power resistor? Naturally, the size you need is never there. More than likely you pushed a power transistor to one side while looking. Better go back and get it. A power transistor makes a first-rate variable load resistor, good for many uses.

A power transistor can be made to look like either a small or a large resistor. Just change the base input current. The collector voltage will adjust to any source within its ratings. To be safe, stay within one-half the rated collector-to-base breakdown voltage. A resistor in series with the collector will help.

In addition to the transistor you'll need a flashlight cell, a resistor or two, and a low-resistance potentiometer. More than likely these are on hand.

The transistor will be more useful on a heat sink. Terminals for base, emitter and collector connections help avoid wasteful accidents. The small square of Masonite shown in the photo takes but a few minutes to make. It is much nicer to work with something that says put on the bench.

When you have your transistor all set up and ready to go, you will find it of value for other uses as well as for a power resistor. It is very handy as a series regulator when experimenting with power-supply circuits. Or you can make comparisons between different audio and servo-amplifier output circuits. With two similar transistors experiments with push-pull output circuits are quickly made. END

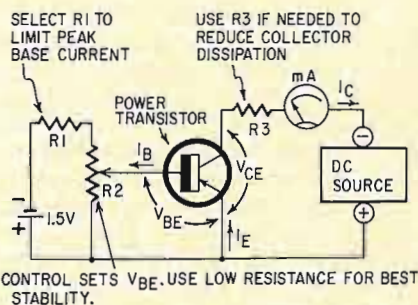

Fig. 1—Adjustment of load current I_L .

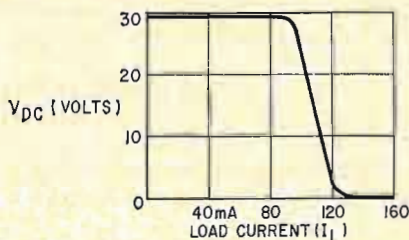
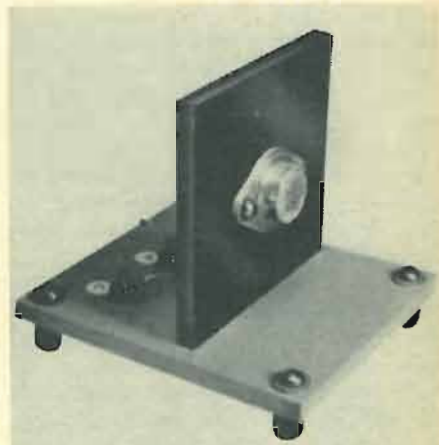

Fig. 2—Voltage-vs-load-current curve.



The transistor should be attached to a heat sink which is mounted on a small Masonite square. This makes for convenient handling when working on the bench. Put terminals for base, emitter and collector connections on base plate.



Power transistor provides load for making measurements on this regulated supply.

The Audio Man's Audio System

Custom sound designed and built by the experts for use at their own conventions

By **THOMAS R. HASKETT**

PROBABLY SEVERAL HUNDRED THOUSAND PA systems are in use today. Many are poorly designed and inefficient, and few are really effective. Where would you find a really great PA system? At a convention of men in the audio business—the Audio Engineering Society.

The problem

Members of the AES are engineers and technicians working in sound recording, broadcasting, acoustics, language laboratories, electronics manufacturing, and even PA-system installation. When they gather for a convention, they need the very same device that many of them earn a living designing, installing and maintaining—a PA system. From modest beginnings and to meet their special needs, the AES has designed and fabricated a system that is probably one of the most up-to-date in existence today. It was field-tested at their October 1966 convention in New York City.

In early AES days—almost 20 years ago—they used existing hotel PA systems for conventions. Such systems, being designed as compromises to fit many needs, weren't entirely suitable for the AES. By 1957, the Society decided to assemble its own system to fit its unique needs. There were three requirements:

1. The voice of the person addressing the convention had to be amplified

so everyone in the audience could hear him.

2. Many of the technical papers delivered at a convention involved the presentation of recorded audio material on disc or tape. Such recordings had to be amplified and the signal fed to speakers so the audience could hear it.
3. All spoken material from the lecturer, questions and comments from the audience, and demonstrated audio material, had to be taped for the permanent files of the AES.

Partial solutions

Beginning with the 1958 convention, AES assemblies used a pool of equipment loaned by various audio manufacturers. A fine idea, but it had one disadvantage: The system had to be redesigned each year, depending on the particular gear loaned. Since the services of the console operators are donated by recording studios, each time the system was redesigned or a different console was used, time was lost. Each operator worked only a few hours during the convention total of about 60 hours, but considerable time had to be spent breaking the man in on the equipment operation.

Simplicity and flexibility became two key points in a desirable convention sound system. What's more, at each twice-a-year convention, the equipment had to be set up in about 12 hours. Set-

ting up a different system each year can be a slow process.

Somehow, the society managed for a few years, finding new ways to overcome old problems. Sometimes a hall had so much reverberation there was an unnatural sound in the rear seats. Low-level distributed speakers and a tape-delay mechanism driving rear speakers minimized this difficulty. When a single channel and the same speakers were used for both speech reinforcement and demonstration material, voice perspective and feedback problems interfered with each other. Using two sets of speakers—one for voice, the other for demonstration—was the solution.

One problem common to the AES and other groups is that most persons who address the gathering are technical people, not experienced public speakers. Such people can speak to small groups with ease, but they freeze up on a stage before a hundred listeners. The talker's anxiety was often made worse by his poor microphone technique. Unaware that he should project his voice, he would often speak in a thin, weak voice, perhaps off mike. If the console gain was turned up, there was the possibility of feedback. When the lecturer turned away from the audience and gestured toward the screen to comment on a projected slide, he strayed farther off mike.

Several solutions to the microphone problem were attempted. A lavalier



The hall as viewed from the console operator's position. Two more speakers are used on right of stage to balance system.



Overhead mikes pick up talker's voice even if he turns to side. Mike at lower right is used for questions from audience.

mike was used, hung on a cord around the talker's neck. But transferring mikes between the first speaker, the program chairman, the next speaker and so on created another problem while it solved the first. Unmiking a lecturer was a nuisance, and he often stumbled on the mike cord. Next a wireless mike was tried. The sound was fine and there was no restricting mike cable, but occasionally a two-way radio harmonic would come popping through to disturb the audience's train of thought.

The best solution to the mike problem was found in 1963, when the lecturer was given complete freedom of movement. In addition to the usual lectern microphone, several long-range directional mikes were hung overhead, as shown in the photo. If the talker turned away from the lectern, his voice was picked up by these high-mounted mikes.

There were other developments during the past 10 years. An automatic-level-control amplifier was added to smooth out volume variations between

various speakers on and off mike. Column speaker systems, because of their extremely directional patterns, could be placed very close to the lecturer without causing feedback. To most of the audience, the talker's amplified voice seemed to come from the person himself, enhancing realism. But when the lecturer walked across the stage to emphasize a point on a displayed slide, another problem was created. His voice seemed to stay at the lectern, and reality was lost.

An ingenious device called a *pan pot* solved the moving-talker problem. A variable attenuator, the pan pot channeled a monophonic signal into two separate speakers at stage left and right. The division of sound between the two was controlled by the position of the arm of the pot. With this device, when the lecturer crossed the stage, his voice could be "panned" between the left- and right-hand column speakers by the console operator. In other words, to the audience his amplified voice would stay with him as he moved.

With mikes hung overhead and

lecturers walking around the stage, that old devil feedback would have crept slowly in, had it not been for the appearance of a device called a *feedback stabilizer*, or frequency shifter. Speech signals are fed into this amplifier, which contains a circuit that shifts the whole frequency spectrum 3 to 5 hertz before sending it on to the loudspeakers. Since speaker acoustic output is not exactly the same as the sound waves from the talker's mouth, the two signals add only slightly at the microphone. The result is that, with the frequency shifter, speaker output in a PA system can be increased more before reaching the feedback point.

There were problems involving the audience, too. After a talk, the lecturer invites questions from those he's addressed. Their voices must be picked up for the permanent tape recording of the session. Hand-held or stand-mounted mikes were nuisances, as the questioner had to go to the mike, or the mike had to be passed to him. The answer was a battery of shotgun mikes aimed at vari-

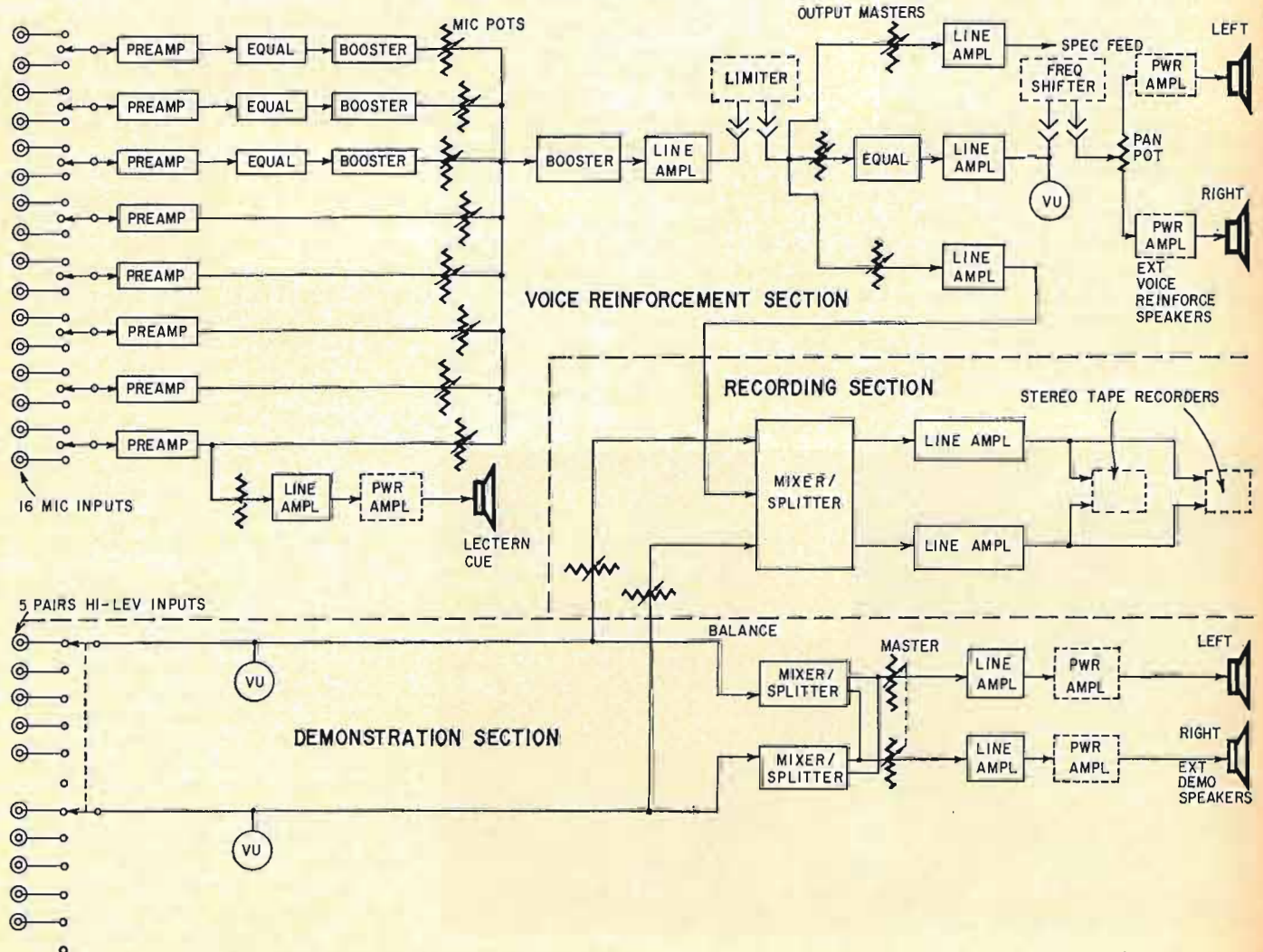

Simplified block diagram of the AES console. Dashed lines indicate components not a part of the console proper.



The console was designed for maximum operator convenience, to reduce possibility of error. Slide-type vertical attenuators conserve space on panel and are easy to use.

ous sections of the audience. No one had to leave his seat, yet his voice could be captured for the record.

One thing learned through these years of experimentation applies to any PA system: The ideal setup should enhance the talker's voice without becoming electronically obvious. In other words, it should be heard but not noticed by the audience—even if they happen to be audio engineers!

The AES console

Early in 1965, the design and fabrication of the present convention console was begun. All work was done by Society members who volunteered their free time. Equipment was donated by generous manufacturers. The console, which is entirely solid-state and uses PC-board modules for all circuits, is shown in the simplified block diagram.

There are 16 low-level microphone inputs, switchable into 8 preamplifiers. The first 3 preamps are followed by

equalizers and booster amplifiers. After the loss introduced by the mike faders and the mixing bus, there follows a booster amplifier and a line amplifier. At this point, jack-field connections allow patching in an external limiting or level-controlling amplifier.

Next the signal is split three ways. The speech-reinforcement output goes through a master attenuator, an equalizer to compensate for hall acoustics and another line amplifier. If used, the frequency shifter is patched in at this point. Finally, the speech signal goes to the pan pot, and then to outboard power amplifiers and a pair of well matched column speakers.

A separate "special feed" output, with its own master pot and line amplifier, can be used for cueing or any other purpose. The third output from the speech-reinforcement section of the console goes through a separate master attenuator and line amplifier. It is then fed to a split-mixing network. More

about this feature will be shown later.

The demonstration section of the console contains five high-level stereo inputs, switch-selected. They are normally driven by the line-level output of tape or disc reproducers. These two-channel inputs are fed through balance pots and split networks, the latter to allow channel reversing or splitting a mono signal into both stereo channels. Next come the master attenuators, line amplifiers, and outboard power amplifiers and speakers.

The stereo demo inputs are also fed through separate attenuators into the split-mixing network mentioned previously. This network and the two line amplifiers which follow it constitute the recording section of the console. The network adds the lecturer's voice to both stereo channels without degrading separation. Line-amplifier outputs are connected to a pair of outboard tape recorders which preserve everything heard at convention sessions.

To make it easier for the lecturer to hear questions from the audience, a separate facility is provided. All audience-reaction mikes are pushbutton-selected into mike channel 8. The output of preamp 8 is tapped off through a separate attenuator, line amplifier and outboard power amplifier. Then it goes to a speaker mounted in the lectern. Thus the lecturer hears only audience questions, and not his own amplified voice.

Nearly every circuit path in the console appears on the patch panel beneath the operator's armrest at the bottom of the slanting top panel shown in the photo. For even greater flexibility, a separate jack field in a standard 19-inch cabinet rack takes care of patching outboard amplifiers, limiters, etc.

All three VU meters may be switched, allowing visual monitoring of every channel and cueing of upcoming demonstration recordings. The meter at the left (top photo) normally rides the output of the voice-reinforcement channel, while the pair on the right are used to monitor the reference tapes being recorded.

The present AES system takes only about 8 hours to set up—including the time for positioning and hooking up lighting, slide projectors and a screen. That's not bad, when you consider that the entire arrangement constitutes a highly sophisticated PA system, a complete recording studio, and facilities for reproducing tapes, discs, and (in some cases) sound-on-film movies. Twice a year the system is used 12 hours per day for 5 days.

My thanks to those members of the Audio Engineering Society who took the time to explain the intricate workings of this magnificent sound system for RADIO-ELECTRONICS readers. END



The system set up and ready for use, with console at left. Rack contains limiter, feedback stabilizer, equalizers and power amplifiers. Tape machines record the proceedings.

NONPOLARIZED ZENER CLIPPER

A technique that eliminates the necessity of obtaining matched diodes in order to clip both sides of a waveform evenly **By RONALD L. IVES**

CLIPPER AND VOLTAGE-REGULATOR CIRCUITS have been greatly simplified during the last 6 years. Biased diodes and overdriven triodes have been replaced by the simple and relatively inexpensive Zener diode. It has long life and requires no power supply, in most cases.

The conventional Zener clipper circuit is shown in Fig. 1. The positive half-cycle of the input waveform is clipped to Zener voltage E_z , the negative half-cycle is clipped to the E_o —offset voltage of the Zener diode, which is now acting as a conventional diode. This offset voltage, for most silicon diodes, either normal or Zener, is between 0.5 and 0.6.

The resistor is a current limiter, to minimize the dissipation of heat in the

Zener. If the circuit of Fig. 1 is fed from a dc supply, it's a most effective voltage regulator.

Clipping of both half-cycles is customarily performed by using two identical Zeners connected back-to-back, as in Fig. 2. In this circuit, on each half-cycle one Zener functions as a voltage limiter, and the other as a conventional diode. Therefore, the peak of each clipped half cycle will be $E_z = E_o$, and E_{out} will be $2 \times E_z + 2 \times E_o$ (peak-to-peak). The output will be very close to a square wave, provided E_{in} is much greater than E_{out} .

The back-to-back circuit is an excellent performer, provided two identical Zeners are used. With high-power

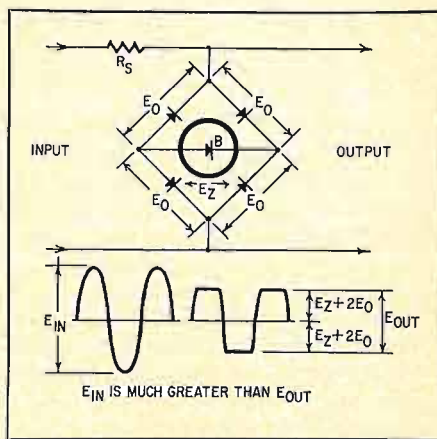

Fig. 3—Circuit of the symmetrical Zener clipper and full-wave bridge rectifier.

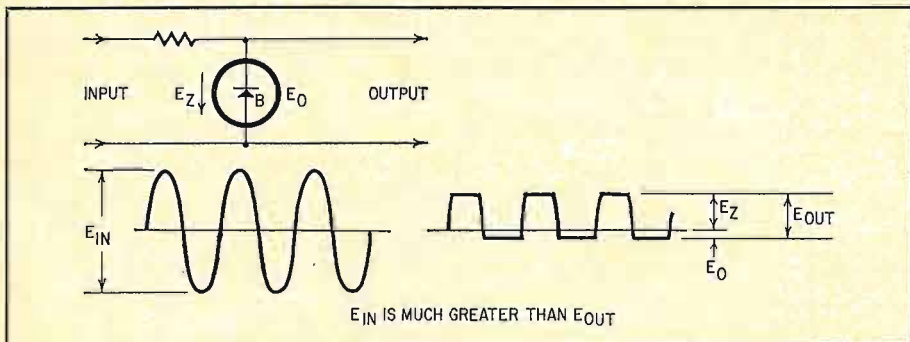

Fig. 1—The conventional single Zener diode circuit clips waveform nonsymmetrically.

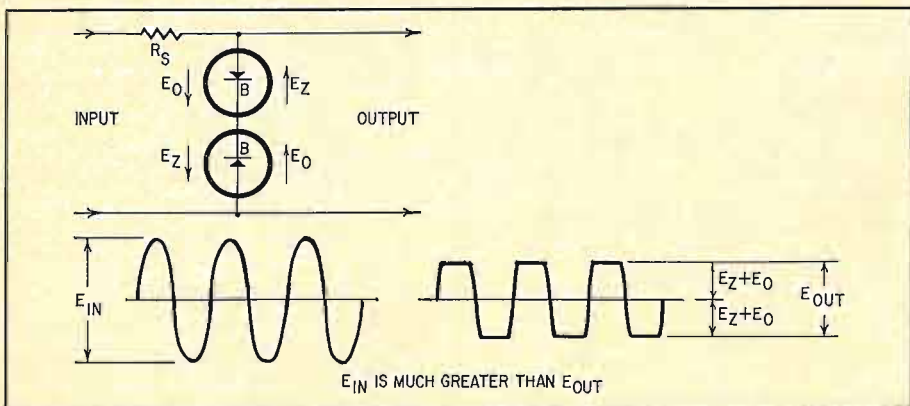

Fig. 2—For symmetrical clipping, a well-matched back-to-back diode pair is often used.

circuits, both diodes can share the same heat sink, which not only saves bulk and expense, but helps to keep the characteristics of both diodes in step.

A double-anode Zener will do just as good a job of clipping, but it's both costly and hard to get.

Recent development of small packaged bridge rectifiers, employing silicon diodes, has made it possible to obtain bilateral clipping with a single Zener, thereby eliminating the matching problem. Usually, the cost is reduced, too. Bridges such as the International Rectifier 10DB6 or Mallory FW series are ideally suited for this purpose.

The circuit of a Zener-bridge clipper is shown in Fig. 3. Due to bridge action, voltage is applied to the Zener diode on each half-cycle, and clipping takes place whenever applied voltage exceeds $E_z + 2E_o$.

Tests of this circuit show that it performs well in a variety of functions from oscilloscope calibration to crash limiting. Component life will be several years, unless the circuit is overloaded. The equipment they are used in is likely to become obsolete before the clipper components fail.

END

Double Feature, Starring Timers

By **RONALD L. IVES**
and **FREDERICK W. CHESSON**

PERHAPS YOU'RE A PHOTOGRAPHER AND develop your own film. You need a device that will time your darkroom developing or enlarging an exact number of seconds. Then, too, you could be an industrial technician at a plant where raw material must be baked, mixed or otherwise processed for an exact number of seconds by automatic machinery. You want a device you can set to control the processing time.

What you need is an automatic timer, or electronic clock control. While you can purchase assembled timers and there are even a few kits, you'll learn more about electronic timing operations and troubleshooting if you build your own.

These two construction projects illustrate the principles of electronic timing. In both, the duty cycle and length of time interval may be varied. Either device will turn an external circuit on and off, or switch between two circuits. One is a vacuum-tube circuit which will repeat its switching action at intervals from less than 10 seconds to 90 seconds. The other circuit is solid-state and switches at intervals from 0.5 to about 17 seconds.

A vacuum-tube timer

The thyatron is a special type of gaseous tube used as an electronic switch. Two things are necessary to turn it "on" (start conduction)—both the

grid and the plate must be positive with respect to the cathode. However, once it is turned on, there is only one way to turn the thyatron off—by breaking the flow of plate current. (This can be done by making the plate negative with respect to the cathode, or by simply disconnecting the plate or cathode from the rest of the circuit.)

The thyatron is ideally suited to be the heart of a timer. Fig. 1 is the circuit: Rectifier-filter circuit R2-D1-C2-R3 produces negative bias of -150 volts, which is tapped off by R3, the CALIBRATE control. This voltage is used as grid bias, as you'll see later. First assume that the recycling circuit, through contacts 1-2 of RY1, is open at point X. After power has been on for several seconds, the thyatron conducts on positive half-cycles at its plate. This energizes RY1, and its armature pulls down. Shunt capacitor C6 charges and holds the relay during negative half-cycles (when the thyatron isn't conducting). C3 is connected to the bias-voltage source through contacts 3-4 RY1; hence the capacitor charges to the voltage at the arm of R3.

If the cathode circuit of thyatron is now opened momentarily—by depressing the armature of RY2—the thyatron no longer conducts. RY1 is thereby de-energized, and its armature rises, placing the contacts in the "up" position. The negative voltage on C3 is now applied through contacts 4-5 to the thyatron grid, in parallel with resistive network R5 through R9. This negative

bias prevents the thyatron from conducting.

This bias gradually leaks away through the resistive network, eventually bringing grid voltage to the tube firing point. When V conducts, it again energizes RY1. This switches C3 back to the "charge" position, and applies ac voltage through contacts 1-2 of RY1 to recycling network D2-R11-RY2-C5. The open circuit at point X is closed.

With point X closed, operating pilot lamp PL3 lights and C5 charges slowly through D2 and R11. In about half a second the voltage across C5 is sufficient to actuate RY2, pulling down the armature. This opens the V cathode circuit, starting another time-limited nonconducting cycle. C4 counteracts the effects of any residual ionization in V.

Delayed recycling is needed so C3 can be fully recharged during conducting cycles of V. If the recharge cycle is too short, timing will be erratic.

A panel control is provided for phasing the timing cycle, if necessary. This control (PRESS TO PHASE) discharges C3 and holds the V cathode circuit closed. When the control is released, a nonconducting cycle of thyatron operation starts immediately.

High-resistance network R5-R6-R7 is a grid equalizer. It offsets most of the effects of contact potential generated in the grid-to-cathode circuit of V.

The circuit to be controlled is connected to contacts 6-7 or 7-8 of RY1, which appear on terminals at the rear of the case. Note that, although there's no

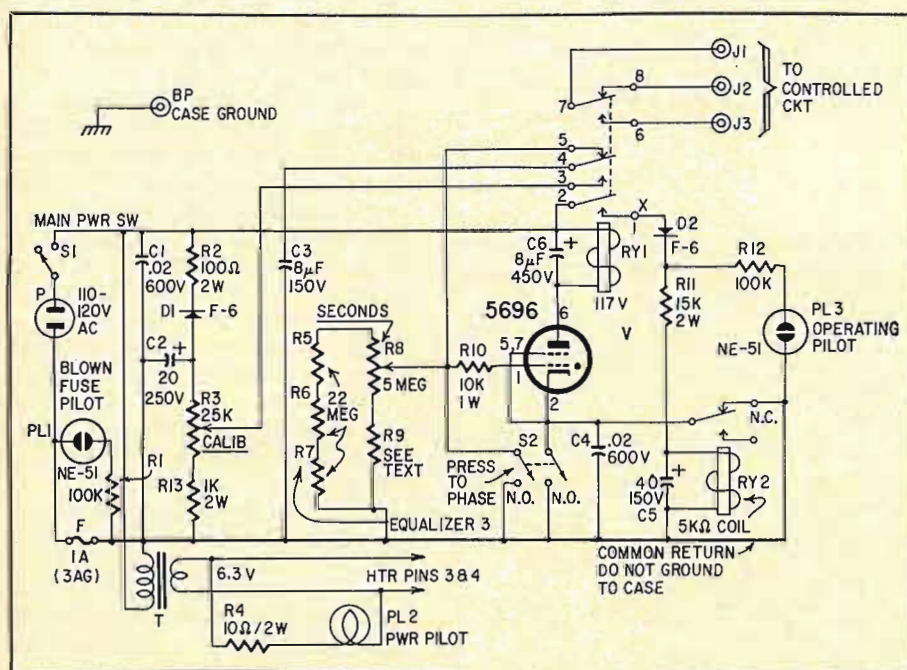

Fig. 1—This vacuum-tube timing circuit uses a computer thyatron for reliable service.

Parts list for vacuum-tube timer

- C1—.02 μ F, 600 volts, disc ceramic
- C2—20 μ F, 250 volts, electrolytic
- C3—(2) 4 μ F, 150 volts paper, in parallel
- C4—.02 μ F, 600 volts, paper tubular
- C5—40 μ F, 150 volts, electrolytic
- C6—8 μ F, 450 volts, electrolytic
- F—1 amp, type 3AG, with fuseholder
- P—117-volt panel receptacle (Amphenol 61 M or equivalent)
- PL1, PL3—NE-51 lamps
- PL2—No. 44 lamp
- R1, R12—100K, $\frac{1}{2}$ watt, carbon
- R2—100 ohms, 2 watts, carbon
- R3—pot, 25K (Ohmite CU 2531 or equivalent)
- R4—10 ohms, 2 watts, carbon
- R5, R6, R7—22 meg, 1 watt, carbon
- R8—pot, 5 meg (Ohmite CU 5052 or equivalent)
- R9—see text
- R10—10K, 1 watt, carbon
- R11—15K, 2 watts, carbon
- R13—1,000 ohms, 2 watts, carbon
- RY1—3pdt, 117 volts (Potter & Brumfield MR-14D or equivalent)
- RY2—spdt plate type, 5,000-ohm coil (Potter & Brumfield LM-11 or equivalent)
- D1, D2—silicon diodes (Sarkes Tarzian F-6 or equivalent)
- S1—spst bat-handle toggle
- S2—dpst pushbutton (NO)
- T—filament transformer, 6.3 volts (Stancor P-6143 or equivalent)
- V—thyatron, type 5696 (Note: Do not substitute type 2D21)
- Handle—Stanley No. 3 door pull, or equivalent
- Chassis—5 x 8 x 2 box
- Rubber feet (4)



Neat labeling enhances front panel of the vacuum-tube timer. It's also a good idea to tag back-panel controls and switches.

transformer isolating the plate of V1 from the ac line, the timer is not a hot chassis. There must not be an electrical connection from the line to the chassis, the case or the output terminals.

The timer is built in a utility box with a strong carrying handle and rubber feet. Neither panel nor interior layout is critical, with two exceptions. You must allow easy access to the relay contacts so you can keep them clean, and the CALIBRATE control must be reachable for adjustment. Also, it's a good idea to place the thyatron as far as possible from the timing capacitors. While a tube shield is used on V, it's merely serving as a holddown, to prevent the tube from coming loose in transit. A spring retainer would do just as well. R3 has a dial and a dial lock, taking much guesswork out of calibration adjustments.

The photos show suggested panel and interior layout. Note the use of tie points, which make troubleshooting and parts replacement easy.

Assembly is straightforward, and standard 10% components are used. The exception is R9, the value of which must be determined by the kind of pot you choose for R8 and the circuit you use.

In any good carbon pot, the ratio of resistance to rotation is substantially linear in the middle of the range. Close to each end, however, the ratio becomes nonlinear. By adding a resistor at the low-resistance end of R8, dial linearity can be extended to cover the range from 5% to 95% of rotation.

To determine the value of R9, connect an ohmmeter from the low end of R8 to the arm. Measure and record the resistance at each 10%-of-rotation point, up to 90%. Now, by subtraction, determine the successive differences in resistance between points. Those from 10% to 20%, 20% to 30%, 30% to 40%, etc. should be similar, and perhaps

identical. From 0% to 10% will be a considerably lower value—the "end effect" mentioned previously. Find the average of the differences from 10% to 90%. From this average, subtract the measured value for the 0% to 10% position. The figure you obtain is the value of R9. You may have to juggle standard values, making up a hybrid of series and/or parallel resistors, to come up with the required value.

You can calibrate the timer easily with an ordinary electric clock that has a sweep second hand. Before you install the timer in the case, plug in the ac, turn on the power, and let the timer warm up for half an hour. Put a piece of paper between contacts 1-2 of RY1, so the timer won't recycle automatically. Con-

nect an electric clock in series with the ac line and the timer rear terminals, so the clock will run *only* when the RY1 armature is up.

Set the clock at zero seconds, the timer CALIBRATE control at approximately mid-range, and the SECONDS control (on the panel) at 50. Trigger the timer by depressing and releasing the armature of RY2. After the timer has gone through one cycle, note the elapsed time indicated by the clock. If the interval is more than 50 seconds, reduce the bias voltage by resetting the CALIBRATE control toward the low end. If the interval is less than 50 seconds, do the opposite. Make another trial run and continue adjustment until the clock-measured time is exactly 50 seconds, matching the SEC-

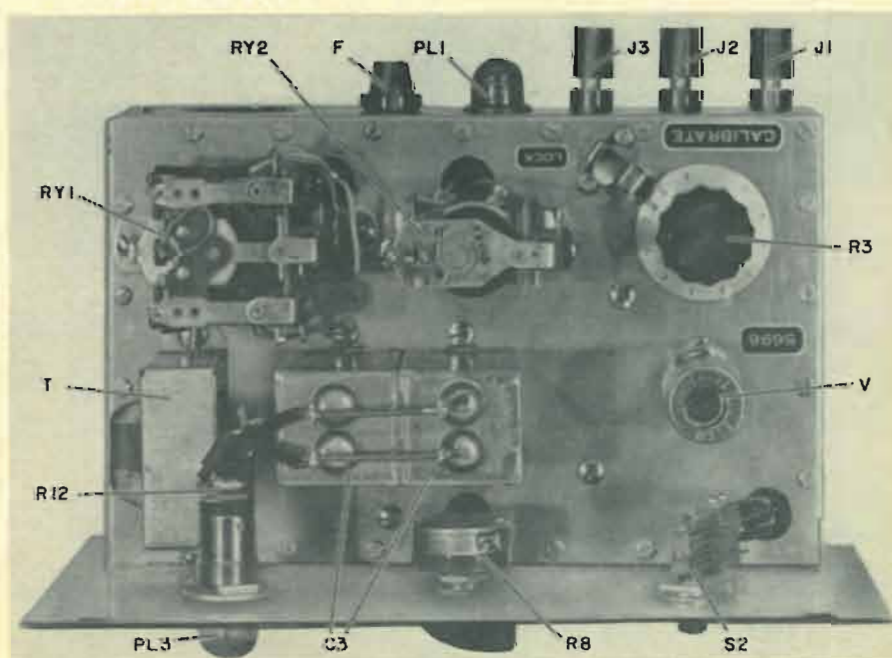

While parts layout of the VT model isn't critical, CALIBRATE knob should be handy.

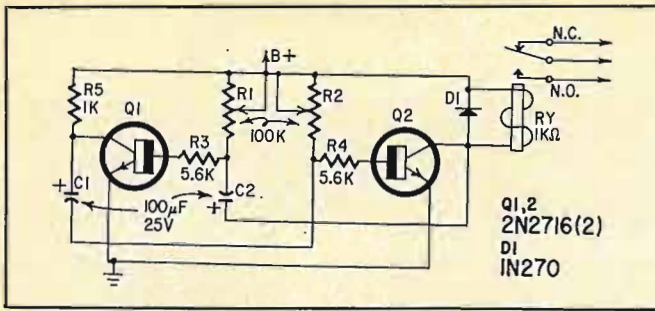

Fig. 2—Basic circuit shows operation of the solid-state timer.

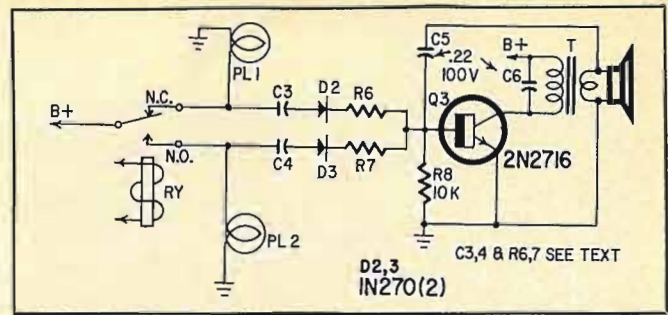

Fig. 3—Indicator unit which can be used with timer of Fig. 2.

ONDS control setting. At this point, lock the CALIBRATE control in position.

You might also check other SECONDS settings for accuracy, but don't change the calibration. All settings should cause timing intervals within 1 second of dial indication, from slightly below 10 to about 90. Above 90, the "end effect" will destroy accuracy.

When you've completed calibration, remove the paper from RY1 contacts, put the timer in the case and install the back plate.

With the timer illustrated, 220K was needed for R9 to linearize readings from dial zero to dial 10. SECONDS readings were then on the nose at 10, 20, 50 and 80, and in error by not more than one second at all other settings—insignificant in most applications.

Long-term accuracy of the timer is good. Calibration drift after six weeks of continuous operation was only 1%. Time settings are accurately resettable—within 0.5%.

With careful construction and good components, maintenance will be minimal. Both relays have an expected life

Parts list for solid-state timer

C1, C2—100 µF, 25 volts	R5—1,000 ohms, ½ watt
C3, C4—see text	R6, R7—see text, ½ watt
C5, C6—0.22 µF, 100 volts	R8—10K, ½ watt
D1, D2, D3—1N270	RY—spdt, 1,000-ohm coil (Sigma 4F or equivalent)
Q1, Q2, Q3—2N2716 (G-E)	SPKR—3- or 4-inch PM, 8-ohm voice coil
R1, R2—pot, 100K	Miscellaneous—meter-case cabinet, Bud CMA or Premier ASPC; 5-terminal Jones strip; binding posts; circuit board.
R3, R4—5,600 ohms, ½ watt	
T—output transformer, 500-ohm pri to 8-ohm sec (Lafayette TR 116 or equivalent); center tap not used	

of several million operations. Don't overload the contacts of RY1 with an external load. These contacts are rated at 5 amps *noninductive*. If you use an inductive load, you must use a kickback-suppressing capacitor or the relay contacts will fail in short order.

The 5696 computer-type thyatron is often replaced after only 1,000 hours in highly critical applications. The one in the timer shown, however, is still performing satisfactorily after 8,700 hours.

The best rule is that the tube should be replaced when the timer calibration begins to drift badly.

The solid-state timer

This device uses a different approach to electronic timing. The heart of the circuit (Fig. 2) is an astable or free-running multivibrator. The relay in the Q2 collector circuit is switched back and forth between two contacts by the oscillator. The repetition rate and duty cycle are governed by the settings of pots R1 and R2. Resistors R3 and R4, in the transistor base circuits, were found helpful in sharpening the switching action by linearizing currents from coupling capacitors C1 and C2.

This timer was built to light two lamps alternately and produce an audible "beep" each time it switched. The indicating circuit is shown in Fig. 3. The relay is switched by the timer of Fig. 2, firing first one lamp and then the other. Each time a lamp fires, a surge through C3 or C4 triggers blocking oscillator Q3 into a brief tone pulse. If either lamp burns out, the capacitor discharge path is opened and further beeps (on that half of the duty cycle) will be either weak or absent. Likewise, any change in the timer repetition rate or duty cycle will be similarly apparent.

If you eliminate C3 and C4 and use equal values for R6 and R7, the unit will produce a continuous tone that shifts in pitch, depending on which lamp is lighted. Another circuit variation is to replace the spdt relay with a dpdt model. Then you can sample a pair of voltages or signals and still have visual and aural monitoring of switching action.

An ideal housing for this timer is a universal meter case, which can accommodate a 3- or 4-inch PM speaker in the meter cutout. The knockout holes in the case top can be used to mount adjusting pots R1 and R2, as shown in the photos. The perforated board used for mounting components is attached to the case back, the relay mounted inside.

The dials shown in the photo were calibrated in terms of shaft rotation, rather than on-off times. You might find it handier to compile a chart of time and duty cycles for any given pairs of

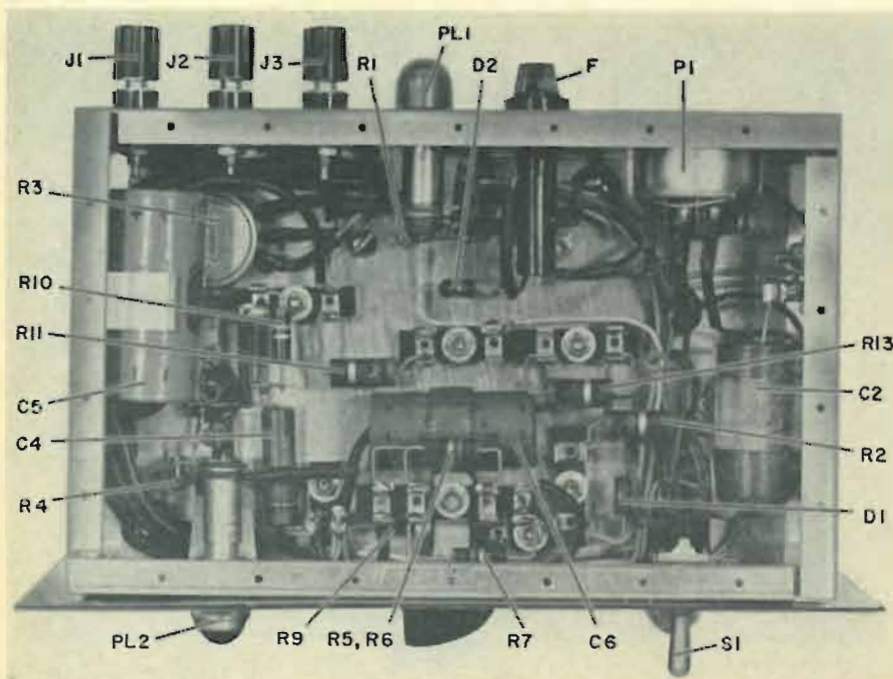

Underchassis view of thyatron unit shows suggested placement of most components.

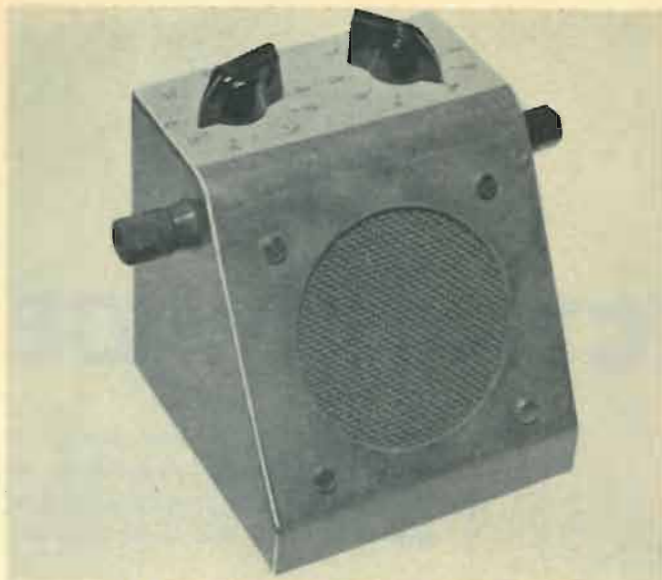

Assembled solid-state timer-indicator fits into a meter box.

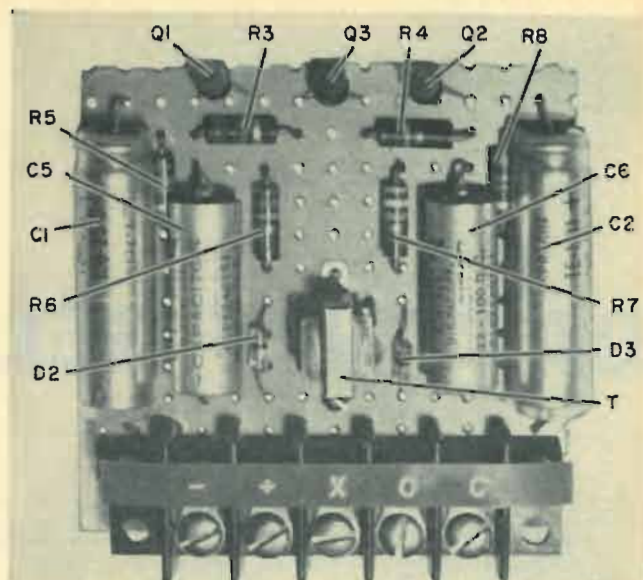

Components in transistor timer mount on perforated board.

settings of R1 and R2. As an example, the following values of resistance vs. repetition rate apply when R1 and R2 are equal and the duty-cycle is 1:1.

R1, R2 in ohms	Time in sec
8K	0.5
10K	0.7
15K	1.7
22K	3.3
33K	6.0
47K	8.0
68K	12
100K	16-17

Fig. 4 is the schematic of the combined timer and audio indicator. D1 damps out induced transients in the relay coil. Diodes D2 and D3 isolate the two circuits being activated by the relay.

It's often convenient to power the timer and indicator from the external circuit which it controls. If 12 volts dc is easily obtainable, fine. The specified 2N2716 transistor has a V_{CE0} breakdown rating of 18 volts. For a higher-voltage supply, you could substitute a 2N3404, which has similar h_{fe} transfer characteristics but a 50-volt V_{CE0} rating. For portable use, a self-contained supply would be useful, and a pair of 6-volt batteries, such as Burgess Z4, Eveready 724 or RCA VS068 will do nicely.

C3 and C4 aren't specified, since their value, as shown in Fig. 3, depends on load impedances. Likewise, values of R6 and R7 depend on your particular requirement. Their resistances determine the pitch of the indicator tone, so you may want to use adjustable pots.

The model shown here was used in the following hookup: The common relay terminal was connected to a 12-volt supply. The normally closed and normally open terminals of the relay were connected to the signal lamps (Fig. 3).

Type 53 lamps, rated at 0.12 amp at 14 volts, were used. C3 and C4 were connected between the relay terminals and the audio-indicator input terminals. By trial and error, it was found that $2 \mu F$ produced a tone burst of about 0.1-sec duration. R6 was made 38K, and R7 18K, to produce different tones for each lamp. Later, for continuous tones, the capacitors were omitted and R6 and R7 were increased to 47K and 68K.

This timer can easily be adapted for darkroom use, as Fig. 5 illustrates. A dpdt relay is used, and the lamps are replaced with 470-ohm resistors.

To operate, open enlarger lamp switch S before turning on the timer. Adjust pots R1 and R2 so the closed time is the desired printing interval, with the open time about 5 seconds. With the darkroom lights off and the timer beeping away, wait for that moment when the open-circuit tone comes on. When it does, close the enlarger-lamp switch. After a pause, the closed-circuit tone will sound and the lamp will turn on. At the end of the exposure time, the lamp will go out with the return of the open-circuit tone. Don't forget to open the enlarger switch!

END

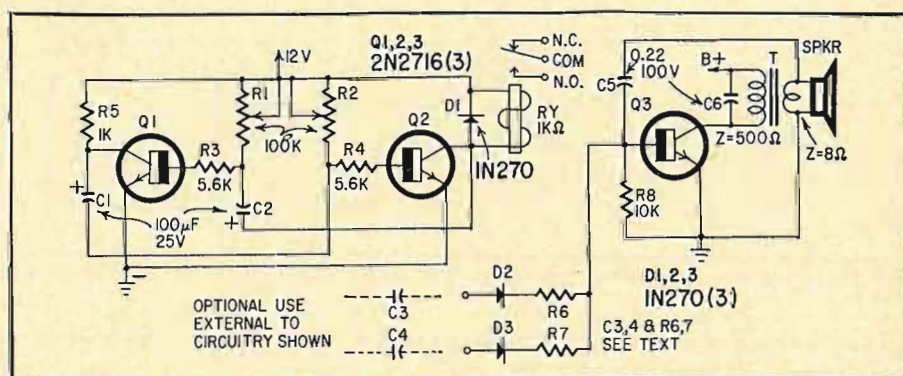

Fig. 4—Complete diagram of solid-state timer and indicator. C3 and C4 are optional.

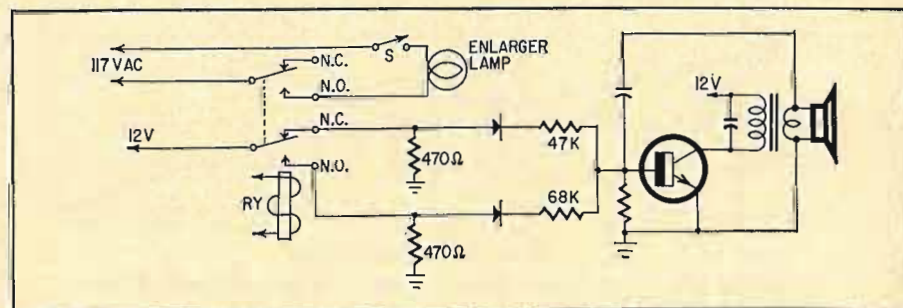

Fig. 5—An example of the versatility of the timer—in the photographer's darkroom.

BATTERY SELECTION GUIDE

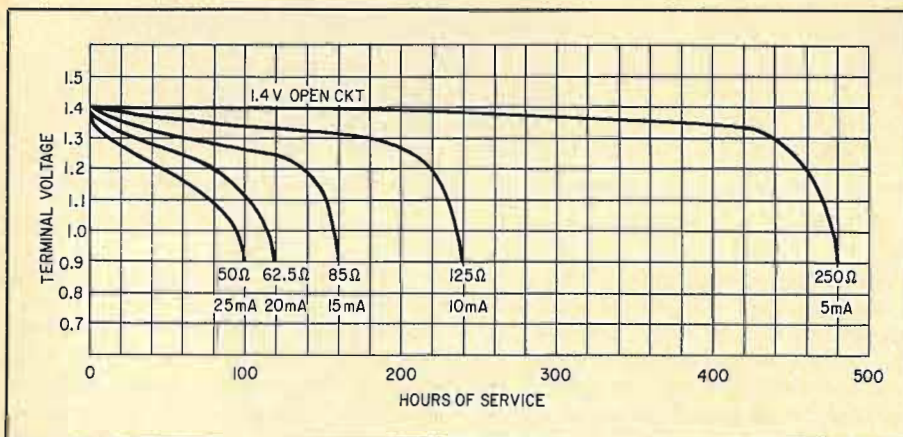

Fig. 1—These are typical voltage-discharge curves for a mercury cell, NEDA No. 15M.

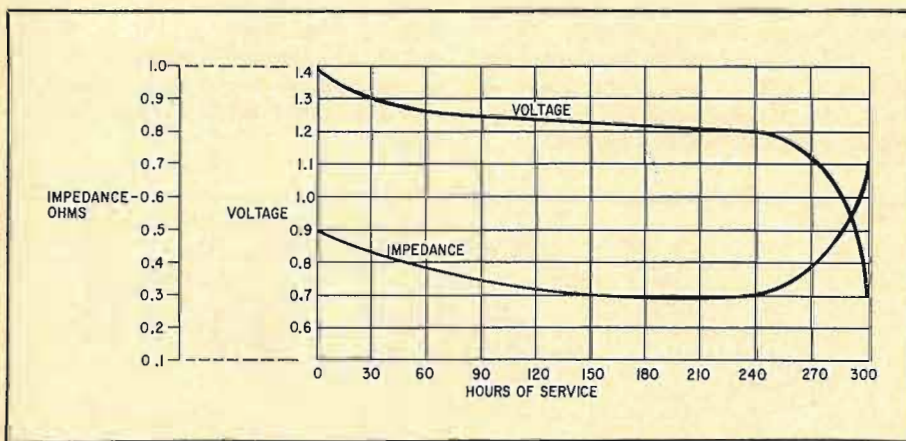

Fig. 2—Impedance (at 1 kHz) vs voltage, 15M mercury cell. As E drops, Z increases.

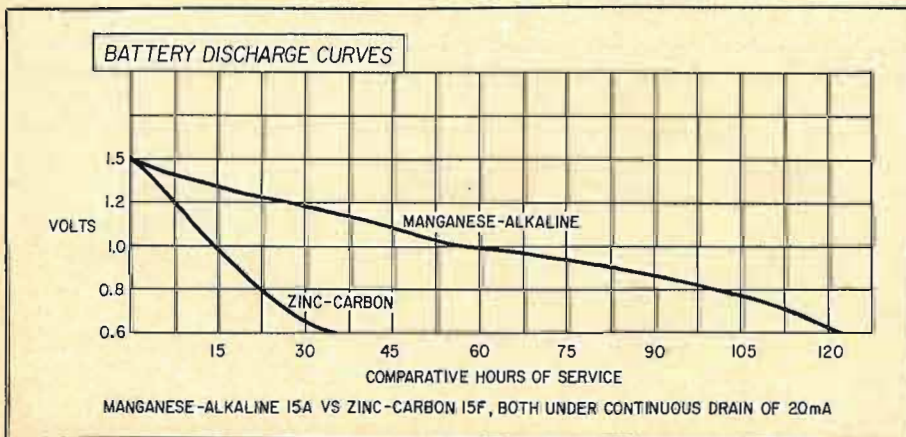

Fig. 3—Comparative service, manganese-alkaline 15A vs zinc-carbon 15F, 20 mA drain.

There's a battery best suited to each application—depending on the current drain, hours of use, and above all the cost per cell

WITH SO MUCH BATTERY-POWERED equipment in use today, and with so many types of batteries available, choosing a battery for a particular application can be a real puzzle. The accompanying chart will help simplify the problem.

Batteries are rated in watt-hours per pound (in practical terms, milli-ampere-hours per ounce). The rating indicates battery efficiency. Zinc-carbon cells yield 15 to 20 watt-hours per pound, manganese-alkaline cells give 30, and mercury units produce 45. However, in any application, the current drain should not exceed the battery rating, or metallic ions will not be able to go into solution fast enough. This causes a rise in internal resistance, and the battery dies before it has yielded its normal quantity of energy. This action makes battery selection difficult. Available milliampere-hours for a particular current drain can be computed only for mercury and cadmium cells. For other types—zinc-carbon and manganese-alkaline—service life can be estimated in advance only from published data derived from actual performance figures.

Ordinary zinc-carbon dry cells require frequent "rest" periods. During use, the cells' internal impedance increases due to the formation of hydrogen gas. This gas must be given a chance to dissipate or the useful life of the cells is shortened.

Zinc-carbon cells today are made in four types, depending on the intended service. The general-purpose variety is most common, and is usually called a flashlight battery. The second type is designed to operate under light drain and to maintain relatively constant terminal voltage for a longer period than can the first type. It's used in transistor circuits. The third special kind of cell is made for photoflash use,

where it's subjected to an intermittent but very high current drain. The fourth type was developed for heavy-duty industrial use.

Manganese-alkaline cells can be up to 75% more efficient than zinc-carbon cells. This efficiency is chiefly useful in high-current applications, as they were designed for such use. Further, precautions must be taken in substituting them for ordinary cells. They cause corrosion when in contact with aluminum or copper terminals if there is any leakage of the caustic potassium hydroxide electrolyte. Stainless or nickel-plated steel terminals should be used. In spite of this disadvantage, manganese-alkaline cells are being used increasingly in receivers and amplifiers. Because they have a relatively constant internal impedance, they can be discharged to lower-than-usual voltages without causing distortion.

Even better in this respect are mercury cells. A 15M, for instance, can give about 220 hours of service at a drain of 10 mA before its impedance begins to rise (Fig. 2).

Mercury cells are also better when stable operation is required. Their output voltage remains nearly constant throughout their useful life. Nor can their performance be surpassed when shock, vibration or moderate heat are problems. They are designed for use at room temperatures or above, and are excellent at body temperatures, as in hearing aids. (A special wound-anode type is available for use at low and freezing temperatures.)

A usual requirement of nickel-cadmium cells, because of their low voltage, is that the equipment be especially designed for their use. N-C's are economical only if you have facilities for recharging them.

On the other hand, when not discharged below 1.1 volts, they are able to take 200 to 300 recharges. Recharging can be done with a simple half-wave rectifier consisting of an inexpensive filament transformer, a diode and a 1-watt resistor. More elaborate circuits are sometimes used. Each size of N-C cell requires a different charging rate and therefore a different charging circuit. Recommended rates and circuits will be found in the various manufacturers' manuals.

These cells should not be used in emergency equipment since they have a poor storage life. At normal temperatures N-C's lose 12% of capacity in the first month, and they will be down to their cutoff voltage by the end of 2 months. They may of course be recharged to their normal capacity.

To select a battery from the chart,
continued on page 66

BATTERY SELECTION CHART

Type	Size	NEDA Number	Current Range mA	Per-Day Duty Hours	Current Drain mA	End-Point Volts	Service Hours	Approx. Price	
Standard Zinc-Carbon, 1.5 volts	N	910F	0-20	2	1	1	440	\$0.08	
	AAA	24F	0-20	2	10	1	37		
	AA	15F	0-25	2	5	1	108	0.10	
					10	1	43		
	C	14F	0-80	2	5	1	240	0.13	
					10	1	110		
	D	13F	0-150	2	5	1	420	0.13	
					10	1	220		
					50	1	40		
					10	1	240		
	D	13D	0-150	4	10	1	580	0.13	
					30	1	185		
	D	13C	0-150	24	50	1	96	0.16	
					100	1	36		
					10	1	530		
30					1	165			
D	13C	0-150	4	50	1	86	0.19		
				100	1	34			
				300	1	4.8			
				10	1	680			
D	13C	0-150	24	50	1	135	0.16		
				100	1	58			
				200	1	20			
				300	1	8.5			
Zinc-Carbon Transistor Types, 1.5 volts	C	15	0-25	2	5	1	275	0.16	
		14	0-80	2	10	1	135	0.19	
	D	13	0-150	2	60	1	50	0.19	
					120	1	20		
					160	1	9		
					60	1	95		
D	13	0-150	2	150	1	30	0.19		
				300	1	8.5			
				4	1	49		0.48	
				10	1	17			
Zinc-Carbon Transistor Types, 9 volts	1604	0-8	2	4	7.2	9	0.48		
				15	7.2	78			
	1604D	0-8	2	4	6.0	32	0.65		
				10	5.4	38			
Manganese-Alkaline, 1.5 volts	N	910A	0-85	24	10	1	52	0.27	
	AAA	24A	0-100	24	5	1	139	0.33	
	AA	15A	0-150	24	10	1	67.5	0.33	
					15	1	38		
	(1/2 D)	927	0-300	24	10	1	290	0.33	
					50	1	155		
	C	14A	0-480	24	30	1	25	0.40	
					150	1	105		
	D	13A	0-650	24	150	1	19	0.50	
					62.5	1	133		
					125	1	60		
					250	1	7		
Mercury	N, 1.4V	910M	0-75	24	12.5	0.9	64	0.44	
	AA, 1.4V	15M	0-200	24	25	0.9	32	0.64	
					50	0.9	13		
	AA, 1.35V	Hg-502R* E502†	0-200	24	5	0.9	480	0.87	
					10	0.9	238		
	D, 1.4V	13M	0-1000	24	50	0.9	46.2	2.44	
					100	0.9	19		
	(8.4V)	1604M	0-30	24	150	0.9	12.5	1.31	
					250	0.9	59		
	Nickel-Cadmium, 1.2 volts	AA	CD6*	0-45	24	45	1.1	10	1.88
		C	CD450†	0-190	24	190	1.1	10	3.40
			CD14*	0-200	24	230	1.1	10	4.05
D		CD7* C2† CD10* CH4†	0-400	24	400	1.1	10	5.70	

* Burgess number
† Eveready number

“Get more
education
or
*get out of
electronics*

...that's my advice.”

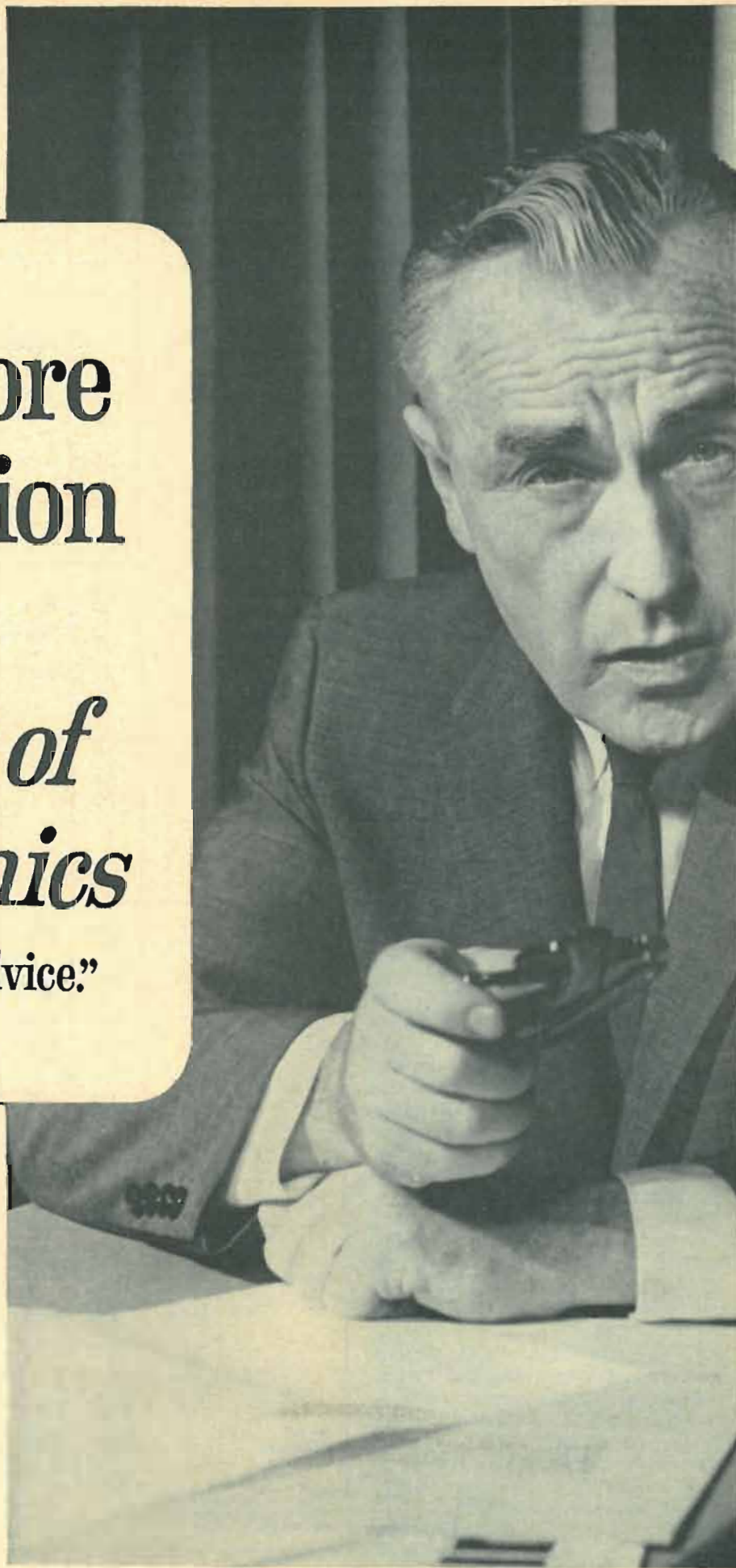



Ask any man who really knows the electronics industry. Opportunities are few for men without advanced technical education. If you stay on that level, you'll never make much money. And you'll be among the first to go in a layoff.

But, if you supplement your experience with more education in electronics, you can become a specialist. You'll enjoy good income and excellent security. You won't have to worry about automation or advances in technology putting you out of a job.

How can you get the additional education you must have to protect your future—and the future of those who depend on you? Going back to school isn't easy for a man with a job and family obligations.

CREI Home Study Programs offer you a practical way to get more education without going back to school. You study at home, at your own pace, on your own schedule. And you study with the assurance that what you learn can be applied on the job immediately to make you worth more money to your employer.

You're eligible for a CREI Program if you work in electronics and have a high school education. Our **FREE** book gives complete information. Airmail postpaid card for your copy. If card is detached, use coupon below or write: CREI, Dept. 1424 E, 3224 Sixteenth Street, N.W., Washington, D.C. 20010.



The Capitol Radio Engineering Institute

Dept. 1424 E, 3224 Sixteenth Street, N.W., Washington, D.C. 20010

Please send me **FREE** book describing CREI Programs. I am employed in electronics and have a high school education.

NAME _____ AGE _____

ADDRESS _____

CITY _____ STATE _____ ZIP CODE _____

EMPLOYED BY _____

TYPE OF PRESENT WORK _____ GI BILL

- I am interested in Electronic Engineering Technology
 Space Electronics Nuclear Engineering Technology
 Industrial Electronics for Automation
 Computer Systems Technology

APPROVED FOR VETERANS ADMINISTRATION TRAINING

THE OXFORD SOUND



It may be the thumping beat of the Nashville Sound or the mechanical music of the Detroit Sound . . . the Sound comes "through" on an Oxford speaker!

Professional musicians . . . on electric guitars, electric bass, or electric organs, depend upon Oxford speakers for the ultimate in response. Every speaker is designed to reproduce the characteristic wave forms of the instrument with which it is used.

Whether you're replacing an existing speaker . . . or designing for O.E.M. applications, the sound choice is Oxford for professional musical instruments!

Write for full information.

OXFORD TRANSDUCER COMPANY
A Division of
Oxford Electric Corporation
3911 S. Michigan Ave.
Chicago, Ill. 60653

Circle 26 on reader's service card

BATTERY SELECTION GUIDE

continued from page 61

determine first the current requirement—let's say 4 mA. Next, experimentally reduce the voltage of the circuit until an end-point, or cutoff, voltage is found—for instance, 1 volt—below which the circuit will not operate efficiently. Now establish the minimum practical length of service that will be required before battery replacement; assume 3 months. This would call for 130 hours of service from a unit used 2 hours per day 5 days per week. The nearest approximation on the chart is the 15F zinc-carbon AA cell drained at 5 mA and yielding 240 hours. No more economical service can be obtained from a 15A manganese-alkaline cell. It can be used for 290 hours, but the increased cost offsets the extra life.

Note, however, that the data given for manganese and mercury cells are for *continuous* usage. Thus, if the duty cycle is changed to more than 2 hours per day and the size limited to an AA cell, then only manganese and mercury cells will fill the bill.

On the other hand, suppose that the end point is 1.2 volts and the usage is 4 hours/day. By raising the end point, we have reduced the total amount of current that can be drawn from the cell. This reduces the number of hours of service. For a 4-hour/day usage, the 14F size-C cell is shown on the chart as delivering twice the current expectable from the 15F size AA at 2 hours/day. Probably, then, the 14F size C is the best bet for a 1.2-volt end point. But a recheck with the chart shows that the same length of service is also obtainable from a 15A AA-size manganese-alkaline. The final decision must rest on the duty cycle, for the 14F size-C zinc-carbon is economical only if the estimated 4 hours/day is never exceeded.

The chart also enables you to effectively substitute one style of battery for another. For instance, suppose a tape recorder with six 15F cells for the amplifier has a maximum drain of 7.5 mA. Would it be cheaper to substitute a type 1604 9-volt transistor battery? No, since 15F cells will give 110 hours of service at 10 mA, and the 1604 only 17 hours at such a drain. In other words, the 1604 gives only 15% of the service for 62% of the cost. Here, in fact, is a case where the ordinary zinc-carbon cell is more economical than any other type, including even the manganese cell.

In another recorder, type 13F D cells drain at 135 mA and need fairly frequent replacement. At the specified

drain, heavy-duty zinc-carbon cells of the 13D type do not give better service than the ordinary 13F cells. Manganese cells might be the answer. As shown in the chart, the 13A gives 63 hours at a continuous 125 mA, as opposed to 36 hours at an intermittent 100 mA for the 13F cells. However, the recorder is never used for more than 4 hours at a stretch, and this is always followed by a 20-hour rest period. The question therefore arises, Wouldn't industrial flashlight cells of the 13C type be much more economical than manganese?

It turns out that they would. This becomes clearer when we consider the two types in terms of their available mA hours (at the drains in the chart that are closest to the recorder's drain of 135 mA). The 13C yields 5,800 mA-hr; the 13A, 7,875 (63 hr × 125 mA). There is apparently 74% as much power from the 13C for only 27% of the cost.

But unfortunately none of the manufacturers compared performance of the two types at the same drains with the result that the data on the manganese given in the chart are at a drain 25% higher than the 100-mA drain of the 13C. Therefore the 13A will yield more power at 100 mA. It computes out to about 8,700 mA-hr. Therefore, the 13A, when at 100 mA, yields about 50% more power than the 13C.

The cost of the cheaper battery times the percentage of better service of the more expensive battery equals the fair premium to pay for the extra service. Since the 13C costs about \$0.16 the fair value of the 13A for this service is $0.16 + (0.50 \times 0.16)$, which is \$0.24. Obviously, with the 13A selling at \$0.50, the 13C is the better buy *for use under the particular conditions*.

There is no simple answer to battery selection, as you can see. However, the chart will enable you to make good choices in most situations. Exact data on many drains, end points and duty cycles that are not given in the chart will be found in the Eveready, RCA and Burgess battery manuals.

Grateful acknowledgement is made to the Mallory Battery Company and Union Carbide Corporation for making special data available for use in this article. END

References

1. Burgess Battery Company, *Burgess Engineering Manual*, 1966.
2. Mallory Battery Company, *The Characteristics and Applications of Advanced Design Dry Batteries*, 1965.
3. National Bureau of Standards, *Specification for Dry Cells and Batteries*, 1959.
4. Radio Corporation of America, *RCA Battery Manual*, 1966.
5. Union Carbide Corporation, *Eveready Battery Applications and Engineering Data*, 1964.

EQUIPMENT REPORT



Lafayette HB-525 CB Transceiver

Circle 27 on reader's service card

WHO NEEDS A 25-CHANNEL CB transceiver when there are only 23 channels in the 27-MHz Citizens band? The new Lafayette HB-525 is a 25-channel set. It is factory-equipped with crystals for operation on all 23 CB channels. It also has sockets and switch positions for 2 extra crystals; these are for operation on the 2 proposed HELP (Highway Emergency Locating Plan) channels when their use is authorized by the FCC. It didn't cost Lafayette much more to add the crystal sockets and 2 additional channel-selector positions. For the user this eliminates the necessity of giving up 2 CB channels or having to modify the set when the HELP channels are authorized.

The CB industry has gone solid-state. The reasons: much lower battery drain, less heat, smaller size, elimination of high voltages, and greater reliability.

The Lafayette HB-525 employs sophisticated design, unusual for a product retailing for only \$149.95. It has a mechanical selectivity filter, noise limiter, squelch, frequency synthesizer, pi network, PA speaker jack, delta tuning switch and an illuminated channel-selector dial.

The HB-525 employs 19 transistors, 6 diodes, 1 thermistor and 12 factory-installed crystals. Circuit arrangements for receiving and transmitting are illustrated in Figs. 1 and 2. It is 6½ inches wide, 2½ inches high and 8¼ inches deep, and weighs 4 pounds, 7 ounces. The unit is designed for direct operation from a 12-volt dc source and can be operated from ac through an optional power supply.

The pi network is used for both transmitting and receiving. But the receiver rf-amplifier tuned-input circuit

has not been left out. There is an overload-protector diode to guard against strong signals at the front end. A series-resonant TVI trap is provided at the antenna end of the pi network.

The transmit frequencies and receiver local-oscillator signals are generated in a frequency synthesizer system employing 11 crystals. One of the oscillators employs 6 crystals, another uses 4, and the third oscillator employs 1. The third oscillator is not used when receiving.

The signals from the first and second oscillators are fed into an up-converter which yields their sum frequency. This sum frequency is then fed into a down-converter together with an 11.275-MHz signal from the third oscillator to produce a beat at the channel frequency. For example: 23.24 MHz + 15.00 MHz = 38.24 MHz. Each of the converter stages employs a three-section bandpass filter to attenuate unwanted frequencies.

The output of the down-converter is fed to the rf power amplifier through a buffer stage and a driver stage. The collectors of both the driver and rf power-amplifier stages are amplitude-modulated by a push-pull class-B modulator.

The output of the up-converter, at a frequency equal to the sum of the first and second oscillator frequencies, is fed to the first receiver mixer. This stage yields an 11.275-MHz i.f. signal, which is passed through an LC filter. The signal then goes to the second mixer, where the 11.275-MHz i.f. signal is heterodyned against an 11.73-MHz signal from the delta-tune oscillator, producing a 455-kHz second-i.f. signal. By means of a front-panel switch, the frequency of this oscillator can be shifted above or below 11.73-MHz to permit clear reception of off-frequency signals.

The delta-tune feature is required because of the sharp selectivity of the

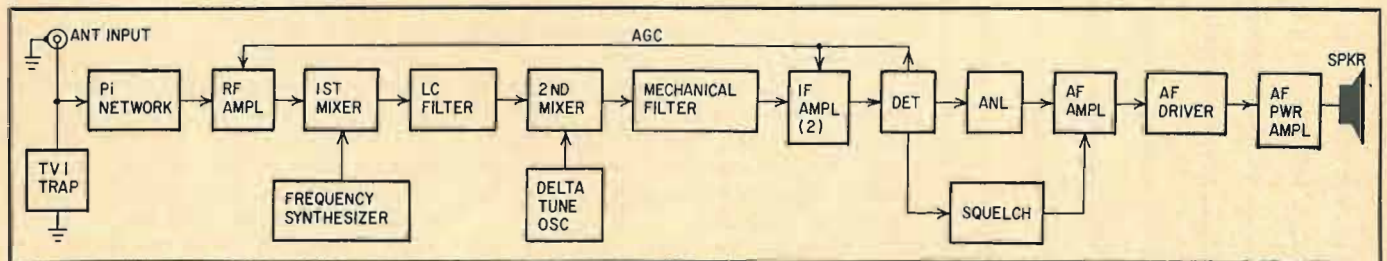

Fig. 1—This is the stage-by-stage lineup of the HB-525 transceiver when in the "receive" mode. The frequency synthesizer "manufactures" 23 channels with only 11 crystals. The delta-tune oscillator permits tuning off-channel transmissions. Front end contains overload-protection diode.

Pick up Special Channels on ANY radio with MINIVERTER II.

Listen to AIR TRAFFIC, POLICE or FIRE DEPT. CALLS, COAST GUARD WEATHER, AMATEUR or any other special frequency you specify.



In seconds, convert any car radio to a sensitive VHF FM/AM receiver . . . without modifying the radio . . . without using extra wires . . . without soldering . . . without special antennas. Available for high band 108-170 mc or low band 30-50 mc reception. Each unit tuneable over a 1.0 mc range.

Installation of basic unit is easy and foolproof. Adjustable automatic squelch circuitry (included) is quickly installed by adding two wires to radio, giving full squelch capability at no additional cost. Unit measures 3" high and is unconditionally guaranteed if installed and used properly. Instructions for home radio installation included with each unit. Brochure on request.

only \$29⁹⁵ complete

I enclose check/money order (No COD's)
MINIVERTER II UNIT(s) @ \$29.95 ea.
mc, exact frequency desired.
send free brochure.

Name _____
Street _____
City _____
State _____ Zip Code _____

SCIENTIFIC ASSOCIATES CORPORATION
BOX 276, S. GLASTONBURY, CONNECTICUT
Telephone 203-633-1971

Circle 28 on reader's service card

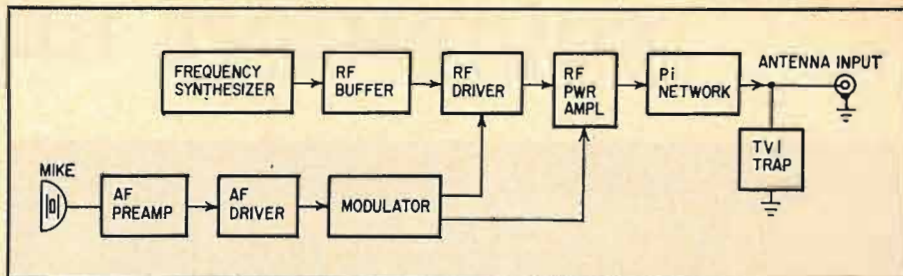

Fig. 2—When transmitting, the HB-525 functions as this block diagram illustrates. Some stages are used in both transmit and receive modes. Note use of two-stage modulation.

i.f.-amplifier system, which employs a 455-kHz mechanical filter at its input. The rf amplifier and both i.f. amplifiers have agc, which is very helpful with varying signal levels.

The HB-525 has all the features

required for personal and business use in the Citizens band. It's a good example of the sophisticated engineering now employed in the CB industry in this country.—Leo G. Sands

Price: \$149.95

Knight-Kit KG-895 All-Transistor Stereo

Circle 29 on reader's service card



IN EXAMINING THIS HIGH-POWER amplifier one is impressed by its size and weight. Ultraminiaturization in solid-state hi-fi equipment is a thing of the past, and rightly so. Knight saw field trouble would be caused by compressing 120 watts of music power into a compact chassis. Instead, their engineers spread out components in a carefully planned chassis. It contains adequate heat sinks for the eight conservatively operated power-output transistors. There are four per channel in a low-voltage, high-current bootstrap arrangement. There is a large, cool-running power transformer equipped with a hum-reducing copper strap.

Conveniently grouped on a fully shielded and enclosed input panel are the phono, tuner, tape and tape-head inputs, the last equalized for NAB standards. There are also two auxiliary inputs per channel.

Outputs for tape recording are provided at low impedance, together with facilities for tape recorders equipped with a separate monitoring head. While a means is provided for op-

erating two sets of stereo speaker systems, front-panel switching does not permit operation of both pairs simultaneously. This is a wise precaution, since even the best audiophiles often fail to heed impedance warnings in instruction booklets. Although speakers as low as 4 ohms may be used with the KG-895 with absolute safety, two such 4-ohm speakers must not be paralleled on one output. This would reduce the effective impedance seen by the output transistors to 2 ohms—a condition which is hardly fair to output transistors.

However, even this misuse would not cause permanent damage to the output transistors; they are fully protected by vacuum-sealed circuit breakers which pop open if output current is excessive. In fact, we deliberately shorted the output of one channel. (This must be done *deliberately*; the speaker terminals are on a barrier strip.) When we drove the amplifier to 60% rated output power, the circuit breakers did their job instantly. The output transistors were in no way damaged after this experiment, and performed

just as well as their opposite-channel counterparts.

The brushed-gold aluminum front panel is attractive, but more important, it contains control knobs and switches you don't find in so-called "simplified" arrangements. There are the usual balance, level, bass and treble controls. (The tone controls are the clutch type, permitting independent compensation for each channel.) A switch is provided which offers four values of loudness compensation. The functions of high- and low-frequency filters (6 db per octave above 3,000 Hz and below 50 Hz, respectively), normal-reverse, tape monitor, speaker selection and power on-off are all actuated by logically placed, positively operating rocker switches. The program-selector switch is not surrounded by a paragraph of nomenclature. Instead, the signal source in use is indicated by soft illumination of one of six colored rectangular light panels located in the center of the front panel.

Interestingly, the program-selector switch has no stops at each end of rotation, thus, to switch from AUX 1 to TAPE it is not necessary to go all the way through TAPE HEAD, PHONO, TUNER, etc. A minor feature, perhaps, but indicative of a sincere attempt to provide convenience and ease of operation for the user. The usual stereo headphone jack and a stereo-mono rocker switch are also on the front panel.

It was with trepidation that we put the KG-895 through listening and measurement tests. Happily, our ears and test instruments confirmed what our eyes had suspected. The manufacturer's specifications are listed separately, but here are some we measured without regard to published specs.

*Distortion at 1,000 Hz
(one channel only)*

Power Output (rms watts)	Harmonic Distortion (%)
0.5	0.4
1	0.3
5	0.3
10	0.4
20	0.55
40	0.65
50	0.8

Note that our 40-watt measurements actually turned out a bit better than the manufacturer's claim (0.7%). Frequency response (with tone controls adjusted for electrically flat response) at normal listening level was, as expected, better than that listed for full power output, measuring flat within 1 dB from 15 to 38,000 Hz. Power bandwidth (not supplied by manufacturer) was 30 to 18,000 Hz (3 dB, 0.7% dis-

ortion points) at 40 watts rms per channel.

As for the circuitry itself, each channel has a separate, three-transistor shielded plug-in preamplifier module. All signals (both high and low level) are fed through proper equalizing and attenuating networks to this module. The preamp is followed by a separate emitter-follower stage which provides the low impedance necessary for tape output. The tone control and loudness stages, along with the various intermediate filters and rocker-switch circuits are next.

Two transistor amplifier stages per channel compensate for tone-control attenuation. The balance and level controls are located after these stages for best signal-to-noise ratio and lowest hum level. The power-amplifier portion of each channel consists of two voltage-amplifying stages, the driver stage and a driver transformer (notably free of any direct current in its primary winding) which drives the double-push-pull class-B output transistors.

The speakers are connected to the output transistors at zero volts dc, since the four output transistors operate over a voltage gradient from +35 to -35 dc. Each transistor has a maximum of only 17.5 volts across it from emitter to collector—a highly conservative mode of operation for these large TO-3 types.

The only specifications with which we might find fault (and small fault, at that) would be the damping factor and the hum level. A damping factor of 6 seems a bit low for this type of equipment. The hum level did, indeed, measure 70 dB below full power output, as stated by the manufacturer. Residual hum (with volume control turned fully counterclockwise) was not much better, however, measuring only 75 dB below full output.

By the way, the manufacturer supplied me with a wired model of the KG-895, and I therefore cannot comment on how easily this kit can be constructed.

Summarizing, an honestly designed high-power stereo amplifier has to be big, transistorization notwithstanding. The KG-895 is both big and honest.

—Leonard Feldman

MANUFACTURER'S SPECIFICATIONS

- Power output (8 ohms): 60 watts IHF music power, 40 watts continuous sine-wave power, per channel
- Frequency response: ± 1 dB 18 Hz to 30 kHz at full rated power
- Harmonic distortion: 0.7% at rated power output
- Intermodulation distortion: less than 1% at rated power output, 60 Hz and 7 kHz mixed 4:1
- Hum and noise: 70 dB below rated power, tuner input
- Separation: better than 55 dB
- Damping factor: 6 when used with 8-ohm speaker
- Size: 16 3/4 x 15 x 5 1/2 in.
- Price: \$149.95 as kit only

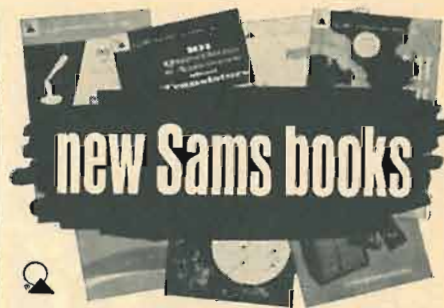

new Sams books

ABC's of Varactors

by Rufus P. Turner. A basic introduction to varactors—a special group of semiconductors whose capacitance varies with the voltage applied. Explains operating principles and describes typical circuits in which varactors are used. Describes use in microwave applications, for which they are particularly suitable, as well as uses in receivers, transmitters, and amplifiers. An easily understandable book for anyone who desires to be informed on this comparative newcomer in the semiconductor field. 96 pages; 5 1/2 x 8 1/2".
Order AVT-1, only..... \$225

101 Ways to Use Your VOM and VTVM

by Robert G. Middleton. New edition, fully revised and updated. Describes and explains all the common and many uncommon uses of the VOM and VTVM. Explains how to make proper connections, how to test and evaluate results. Chapters cover equipment checks, DC voltage tests, ohmmeter tests, signal-tracing tests, DC current tests, alignment applications. 144 pages; 5 1/2 x 8 1/2".
Order TEM-3A, only..... \$295

Experimental Astronautics

by Morris Goran. This book is a valuable introduction to the fundamentals of space science, presenting basic ideas gathered from astronomy, physics, biology, engineering, and other sciences. To understand the principles of space science, it is necessary not only to see these basic concepts in relation to one another, but also in action. The 79 projects described in this book accomplish these two purposes; each experiment uses everyday materials and is simple to perform; you build projects such as a periscope, a ground-effect device, sundial, telescope, and many others. 168 pages; 5 1/2 x 8 1/2".
Order EAG-1, only..... \$325

PHOTOFACT® Guide to TV Troubles. 2nd Ed.

by Howard W. Sams Editorial Staff. Over 200 photos of actual TV picture defects are keyed to specific defective components in typical circuits, so that the source of the trouble is located in minutes. Quick checks are outlined to help you determine rapidly which section is at fault. Includes recent TV models. 192 pages; 5 1/2 x 8 1/2".
Order PFG-2, only..... \$395

101 Ways to Use Your Signal Generator

by Robert G. Middleton. Newly revised edition. The authoritative reference for users of RF-IF and audio signal generators. Covers equipment checks, antenna tests, AM-FM Receiver test, TV receiver tests, and component tests. Shows how to make required connections, how to make tests properly, and how to evaluate results. 144 pages; 5 1/2 x 8 1/2".
Order TEM-4A, only..... \$295

Color TV Guidebook, Vol. 2

This special Howard W. Sams publication offers at amazing low cost, a wealth of useful, practical color-TV data. Discusses latest aspects of color-TV, specific servicing techniques, latest color circuits, outlook for color, new developments—invaluable information you need to keep ahead in color-TV.
8 1/2 x 11". Order PFR-2, only..... \$125

HOWARD W. SAMS & CO., INC.

Order from your Sams Distributor today, or mail to Howard W. Sams & Co., Inc., Dept. RE-2, 4300 W. 62nd Street, Indianapolis, Ind. 46268

Send me the following books:

AVT-1 EAG-1 TEM-4A
 TEM-3A PFG-2 PFR-2

Send FREE Sams Booklist. \$_____ enclosed

Name _____

Address _____

City _____ State _____ Zip _____

My Distributor is _____

CRYSTALS are not all the same!



**INSIST ON
TEXAS
CRYSTALS
BY NAME!**



If your dealer is temporarily out of stock or does not carry Texas Crystals, send us his name along with your request for catalog to our plant nearest you.

Texas Crystals quality is outstanding as evidenced by use in numerous government space projects where there's no compromise with quality, reliability or accuracy. The same dependable performance is yours for CB operation on all 23 channels at only \$2.95 per crystal.

Send for Free Catalog with Circuits



**TEXAS
CRYSTALS**

A Division of Whitehall Electronics Corp.

1000 Crystal Drive Fort Myers, Florida
4117 W. Jefferson Blvd. Los Angeles, California
Phone 813 WE 6-2109 Phone 213 731-2258

Circle 31 on reader's service card

Audio-Color

Lets you see your music



ASSEMBLED	KIT FORM
\$54.95	\$44.95
\$5 DOWN — \$5 MONTH	

Walnut finished cabinet included
Shipped REA Collect

Easy to build, easy to install. All transistor AUDIO-COLOR adds a visual dimension to musical enjoyment. A brilliantly moving panorama of color casts dancing images on a soft frosted screen, reflecting rising and falling volume with each beat of the music. Here's a truly unique and exciting new musical experience. Make check or money order to CONAR.

SEND FOR FREE CONAR CATALOG

CONAR Division of National Radio Institute
Dept. BC7C, 3939 Wisc. Ave., Washington, D.C. 20016

PACE 5803 Laboratory Power Supply

Circle 33 on reader's service card



A POWER SUPPLY THAT WILL FURNISH regulated low-voltage dc is an essential part of almost any laboratory in these transistor days. Although less sophisticated versions can be used for servicing, a supply like the Pace 5803 gives a technician confidence that his equipment is doing the job properly.

To fill the need in the lab (and elsewhere) Pace has developed a supply using two regulator amplifiers in cascade and a separate voltage-reference source. The output is continuously variable from zero to 15 volts with a maximum continuous capability of 2.5 amps. The supply will withstand a short-duration output overload, and is protected

by a circuit breaker for long overloads. Short-circuit current is about 6-7 amps. Two edge-reading meters (see photo) continuously indicate output voltage and current.

The 5803 uses one pnp and two npn transistors in a dc-coupled amplifier circuit and two Zener diodes for regulation and electronic filtering. A center-tapped power transformer and silicon rectifiers D1 and D2 form a full-wave power supply; its negative output is connected to the emitter of Q1. The Q1 collector is connected to the negative output terminal, which is the common ground. With this arrangement Q1 is in series with the negative output lead and

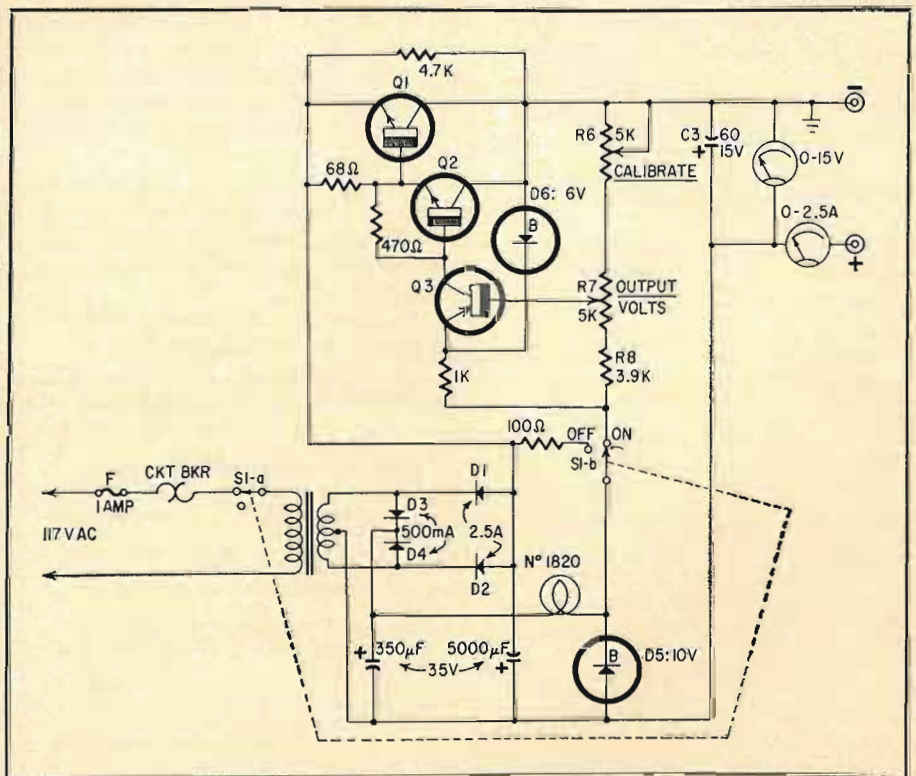

its effective resistance determines the output voltage. The resistance of Q1 is changed by varying the base bias voltage. A more positive voltage will cause the transistor to conduct more and thus look like a smaller resistor (to the power supply). A more negative bias will make Q1 conduct less and look like a larger resistor.

To make Q1 more sensitive to slight changes in output voltage, two additional amplifiers—Q2 and Q3 are used. Also, to provide a reference-voltage source apart from the main dc supply, two diodes (D3 and D4) are added across the secondary of the power transformer. These diodes furnish a positive voltage output, which is fed through the lamp and then to a 10-volt Zener diode. Zener diode D5 furnishes a stable 10-volt reference source through the ON-OFF switch to the base-bias circuit of Q3. This source is also applied to the emitter of Q3 through R2, where the voltage is further stabilized by Zener diode D4. The base of Q3 monitors the output voltage developed across R6, R7, R8 and D5 in series.

To get an idea of how the regulator circuit works, let's assume that a variation in load current has caused a variation in output voltage. This change in the output voltage of Q3 shifts its base-to-emitter voltage and produces a corresponding change in collector current. This changing collector current causes a change in the base currents of Q1 and Q2, which are connected in cascade. The collector current of Q1 then increases or decreases as required to restore the output voltage to its preset level.

In all power supplies using series regulation the power-output capability is roughly proportional to the square of the output voltage. According to the graph supplied with this unit, power output should not exceed about 6 watts at 6 volts but can be as much as 24 watts if the voltage is increased to 12. Why? As output voltage increases, the voltage drop across the transistor decreases. As an example, if the output current is 2 amps at 12 volts, the drop across Q1 is 3 volts. Since power is equal to $E \times I$, Q1 must dissipate 6 watts. If the output is dropped to 6 volts, the drop across Q1 is 9 volts (assuming a nominal 15-volt supply output). With 2 amps output current, Q1 must now dissipate 18 watts, exceeding its rating and shortening its life.

I used this supply to power several transistor receivers (including a large car radio) and could hear no hum in the speaker even near maximum current output. In addition, as far as I could determine, there was no tendency toward instability or motorboating at any load current.

One thing I appreciated about the 5803 was the lack of "cushion" delay. When the voltage is changed, the lightly damped meter follows this change immediately with virtually no overshoot.

The on-off switch operates a "kill" circuit which drops output voltage to zero quickly when the supply is turned off. It does this by placing a 100-ohm resistor across the 5,000- μ F filter capacitor and blocking the regulator amplifiers.

I can recommend this supply as doing a fine job within its capabilities. The output terminals will take bare wire, pin or banana plugs, as well as the dual banana plugs commonly used by laboratories. The small size of the 5803 makes it easy to fit almost any bench. The specifications given by the manufacturer are accurate and even conservative.—Wayne Lemons

MANUFACTURER'S SPECIFICATIONS

Input voltage for full regulation: 105–130 Vac, 60 Hz

Output voltage: adjustable 0–15 Vdc

Output current: 2.5 amps maximum

Regulation (worst case): 1.5%

Regulation (no load to full load, with constant line): 1.0% or less

Regulation (105–130-Vac line): 1.0% or less

Ripple (worst case): 3 mV

Ripple (continuous): 1 mV

7 x 8½ x 2½ in.; 4½ lb

Price: \$59.95



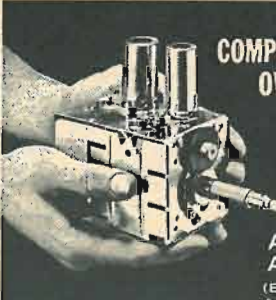

END



COMPLETE TUNER OVERHAUL

9⁹⁵

ALL LABOR AND PARTS
(EXCEPT TUBES & TRANSISTORS)

COLOR TUNERS

GUARANTEED COLOR ALIGNMENT — NO ADDITIONAL CHARGE

Simply send us the defective tuner complete; include tubes, shield cover and any damaged parts with model number and complaint. Your tuner will be expertly overhauled and returned promptly, performance restored, aligned to original standards and warranted for 90 days.

UV combination tuner must be single chassis type; dismantle tandem UHF and VHF tuners and send in the defective unit only.

Exact Replacements are available for tuners unfit for overhaul. As low as \$12.95 exchange. (Replacements are new or rebuilt.)

And remember—for over a decade Castle has been the leader in this specialized field . . . your assurance of the best in TV tuner overhauling.

CASTLE

TV TUNER SERVICE, INC.

5715 N. Western Ave., Chicago 45, Illinois
41-96 Vernon Blvd., Long Island City 1, N. Y.

For service in Canada write to Chicago or use reader service card in this magazine.
*Major parts are charged extra in Canada.

Circle 34 on reader's service card



The 3rd Generation arrives!

INTEGRATED CIRCUITS NOW IN SCOTT RECEIVERS

Brings stations you've never heard before to life with amazing clarity!

First tubes, then transistors and FET's . . . and now, incorporating the most important technological advance of the decade, Scott's new 3rd generation receivers . . . each with 4 Integrated Circuits! Scott Integrated Circuits are designed into the 388 120-Watt AM/FM stereo receiver, the 348 120-Watt FM stereo receiver, and the 344B 85-Watt FM stereo receiver. Now you can hear more stations with less noise . . . less interference from electric razors, auto ignitions, etc. Scott conservatively rates capture ratio of these new receivers at 1.8 dB . . . selectivity at 46 dB! And, you'll enjoy this amazing performance for many, many years, thanks to the rock-solid reliability of Scott IC's. Your Scott dealer will gladly demonstrate to you the astounding capabilities of these new receivers.

Scott . . . where innovation is a tradition



FREE . . . fact-filled, fully illustrated booklet on Scott Integrated Circuits . . . simply circle Reader Service Number 100.

Circle 100 on reader's service card

NEW! LAFAYETTE HB-525 Solid State 2-Way Radio



99-3076WX*

- Size: 2 $\frac{3}{8}$ " by 6 $\frac{1}{4}$ "

149⁹⁵

All **23** Channels
Crystal Controlled

Plus 2 Reserve Channels For H.E.L.P. Program
All Crystals Supplied!

- 19 Transistors, 7 Diodes, Thermistor
- Dual Conversion Receiver for Extra Selectivity and Sensitivity
- Full 5-Watt Input
- Range Boost™ Circuitry for Added Power
- 3-Position Delta Tune—Provides Accurate Fine Tuning
- Mechanical 455KC Filter for Superior Selectivity
- Push-to-Talk Dynamic Microphone
- Variable Squelch plus Series Gate Automatic Noise Limiting
- Public Address System (with external speaker)
- 12-Volt DC Operation (pos. or neg. ground) 6-Volt DC (with optional DC Power Supply)
- Pi-Network for Optimum RF Output

*Imported



FREE

**1967
CATALOG 670**

512 Pages

Featuring Everything in Electronics for
• HOME • INDUSTRY • LABORATORY
from the "World's Hi-Fi & Electronics Center"

LAFAYETTE Radio ELECTRONICS
Dept. J.L-6 P.O. Box 10
Syosset, L. I., N. Y. 11791

Send me the FREE 1967 Lafayette Catalog 670

JB-7

Name

Address

City State Zip

Circle 35 on reader's service card

The Trouble That Couldn't Happen

By MILTON LOWENS

Part II—The Cure

IN A CIRCUIT AS SIMPLE AS THIS ONE, THERE WERE VERY FEW things that could cause complete inversion of the picture. Since voltages were essentially normal, vertical oscillator trouble could be ruled out. The negative voltage on the grid was a clear indication that the stage was functioning, while the stable picture indicated that the oscillator frequency was correct. This left only the vertical output stage which, besides the tube, consisted of resistors in the grid and cathode circuits and the vertical output transformer. Since resistive components cannot possibly cause a phase inversion, that left only the transformer. This reasoning was proved correct as soon as a new transformer was installed, but what could cause the old transformer, a simple unit, to act as it did? I was determined to find out.

I studied the complete schematic diagram and redrew the portion dealing with the vertical output stage in simplified form (Fig. 1). The direction of electron flow naturally was from the plate down through the windings to B+. At the bottom terminal of the transformer (black lead) there should have been *negative-going* spikes which, when applied to the grid of the picture tube, would blank out the retrace lines. However, since removing the spikes had an effect precisely opposite to what would be expected, this clearly indicated, even without a scope, that the spikes were actually *positive-going*. When this peculiar indication was coupled with the inverted picture, only one conclusion was possible: *the direction of electron flow through the windings must have been reversed!* Frankly, I did not see how this could be, since electrons cannot flow from plate to cathode, at least according to the very theories I taught my students. Still, I ordered a new transformer anyway when I discovered that the resistance readings of the windings were incorrect and erratic. While I waited for the new transformer, I performed an autopsy on the suspected unit. Too many competent people had called this "the trouble that couldn't happen" for me to stop now.

I removed the mounting frame and core first. Then, slowly and very carefully, I peeled off the outer layers of insulating cloth and paper from the windings. *There it was!* A tiny black charred spot under the fine enameled wire where it crossed on top of the winding to be soldered to the *blue* outgoing lead (Fig. 2). Directly under this fine wire, separated from it by a thin layer of transparent plastic film, lay the top layer of the winding which terminated in the *black* outgoing

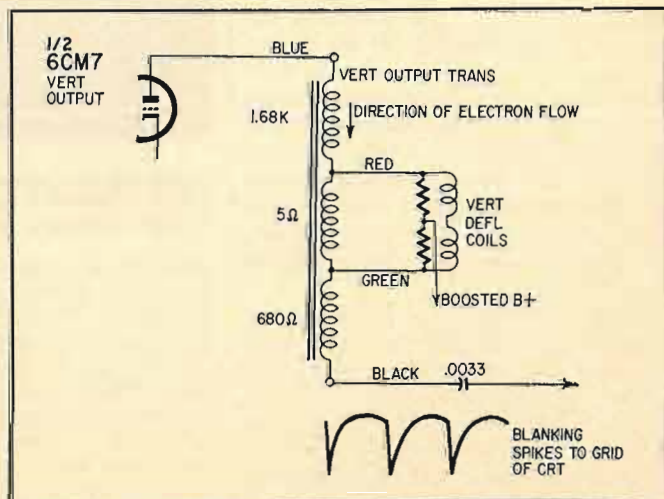

Fig. 1—Simplified vertical output stage in mysterious TV.

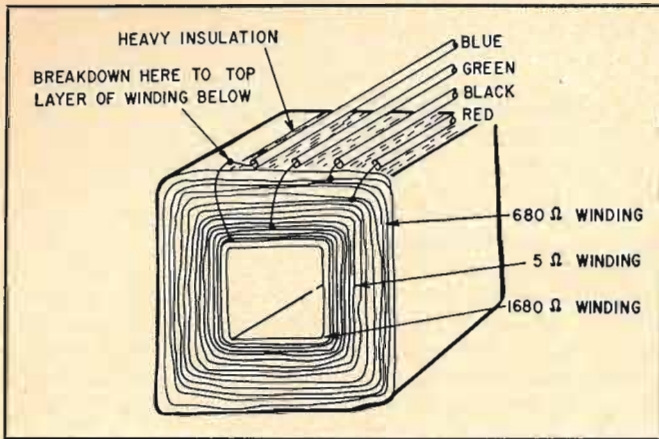

Fig. 2—What happened to the vertical output transformer.

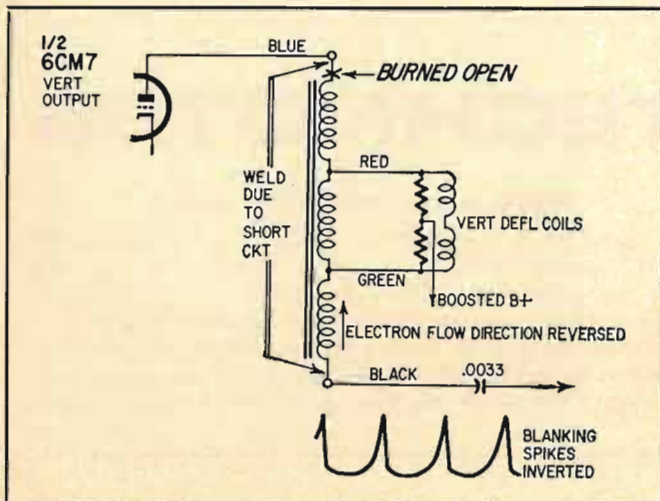

Fig. 3—How flow of electrons was reversed in transformer.

lead. Thus the full sharply-spiked voltage appearing between the ends of the entire winding was opposed by only a few thousandths of an inch of insulation intended to resist only the relatively low voltage between adjacent winding layers. No wonder it had broken down! Only a quarter inch away lay a much heavier piece of varnished cambric which could have stopped the breakdown, but either the wire or the cambric were not where they should have been. And this was enough to cause the whole problem.

As shown in Fig. 3, the breakdown effectively caused a short-circuit of the entire winding. The heat generated welded the black-connected lead to the blue-connected lead. At the same time, the end of the winding ordinarily connected to the blue plate lead burned open. Thus, the effect was exactly as if the transformer had been reversed; this inverted both the picture and the polarity of the blanking spikes. The picture was of less than normal height because there were fewer turns in the winding between the black and green leads than in the normal coil between the red and blue.

So, at last the problem was solved.

"Hey!" you may call. "Not so fast! What about the *backwards* picture? What caused that?"

Well, that one puzzled me a long time too. The set was fixed, the customer was happy and so was I; I had cracked a tough nut and had been well paid. Ordinarily I would have been satisfied to let it go at that except for one thing. I remembered the Magnavox technician pleading earnestly, "If you ever do find out what caused the trouble, would you let me know?"

So to finish it: Did you ever see a vertical foldover at the

Here's the cardioid mike that delivers ALL the audio quality of the \$100-plus cardioids, but sells for at least \$40 less! (List price — \$59.50 everywhere.) The Turner 600 may be held by hand or stand . . . either way, you're assured of top performance, with no 'pop' and no feedback.

Whether you're buying, selling, or simply recommending cardioid microphones that are ideal for any recording job (monaural or stereo) . . . try Turner 600's first. It's the best \$100-plus microphone that \$59.50 will ever buy.

THE TURNER MICROPHONE COMPANY
 933 17th Street N.E. Cedar Rapids, Iowa
 In Canada: Tri-Tel Associates, Ltd.
 Export: Ad Auriema Inc., 85 Broad Street, New York, N.Y. 10004

Sales-wise, profit-wise and otherwise, you'll do very well with Browning CB radio equipment.

Many territories available for Franchised Browning Sales and Service Centers. Sell the nationally advertised Eagle CB base station and Raven mobile unit in your exclusive territory. Complete sales aids and technical assistance furnished. Get all the facts now and cash in on the top selling Browning CB line.

Browning Laboratories, Inc.
Department EA
1269 Union Avenue, Laconia, New Hampshire

Please send me information on Franchised Browning Sales and Service Centers.

NAME _____
ADDRESS _____
CITY _____ STATE _____ ZIP CODE _____



MAIL THIS COUPON TODAY!

browning
LABORATORIES, INC.

1269 Union Avenue, Laconia, New Hampshire 03246

Circle 37 on reader's service card

**BIGGER... BETTER
THAN EVER!**

FREE!



SEND TODAY FOR YOUR NEW
**40th ANNIVERSARY
1967 CATALOG**



YOUR BUYING GUIDE FOR

- Stereo & Hi-Fi Systems & Components.
- Tape Recorders.
- Electronic Parts, Tubes, Tools.
- Phonos & Records.
- Cameras and Film.
- Public Address.
- Citizens Band.
- Ham Gear.
- Transistor & FM-AM Radios.

**252 GIANT VALUE
PACKED PAGES!**

BURSTEIN-APPLEBEE CO.

Dept. RE, 1012 McGee, Kansas City, Mo. 64106
 Rush me the FREE 1967 B-A Catalog.

Name.....
Address.....
City.....
State..... Zip Code.....

Circle 38 on reader's service card

bottom of a picture called "skirt-lifting"? The next time you do, study it closely. You will notice that the picture looks as if it were on a piece of transparent film which had curled up toward you at the bottom. The picture is upside-down and backwards in this region. Now imagine the hem of a real skirt being lifted. The printed pattern striking through to the back of the cloth would be seen upside down and backward. Now imagine the skirt being raised higher and higher until it is lifted all the way. What would you see? Depends on your imagination. If you don't see the Magnavox picture upside-down and backwards you had better keep your mind on your work.

Actually, 100% vertical phase reversal (by 180°) results in a 100% vertical foldover which not only turns the picture upside down but backwards as well. So there was really nothing wrong with the horizontal deflection at all. If you don't believe me, try reversing the leads from the vertical deflection coils in the next set that reaches your bench.

But don't forget to put them back!

END

TECHNOTES

PHILCO 8H25: INSUFFICIENT HEIGHT

Since width was normal, I checked and substituted the 10DE7 vertical oscillator to get full height. No dice—the tube was good. The 10DE7 plate had only 10 volts; normally, it should have had about 125. A check of the schematic indicated that both the boost and B+ voltages were fed to a common tie point, where an electrolytic went to ground (see drawing). This point was the source for the 10DE7 plate.

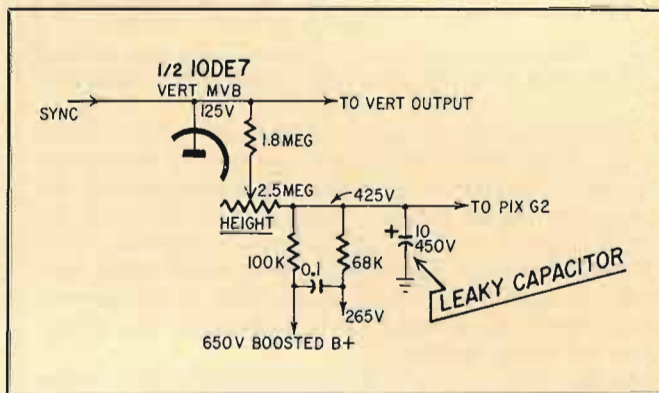

Voltage at the electrolytic was only about 140, whereas it should have been 425. With a capacitor checker I found the capacitance normal, but the power factor was greater than 50%—indicating bad leakage. I replaced the 10- μ F, the screen filled out, and height was okay.—Domenic Ripani

CLEVELAND LATHE SPEED-CHANGE PROBLEM

An earlier Technote stated that failure of a Cleveland Dialmatic lathe to change from rapid-advance to feed speeds was sometimes caused by a defective cam-operated switch on the programmer.

Additional experience has shown that the same trouble may be caused by the two-coil latching relay operated by the cam switches.

This relay will check good on an ohmmeter and will operate at reduced speed but will not change over at normal machine speeds.

Replacement is necessary.—R. C. Roetger

END

NEW SEMICONDUCTORS, MICROCIRCUITS & TUBES

MONOLITHIC DUAL TRANSISTORS

The 2N4099 and 2N4100 are two of a series of dual npn silicon planar transistors made by Union Carbide. The two matched sections of each dual transistor are isolated by dielectric lay-

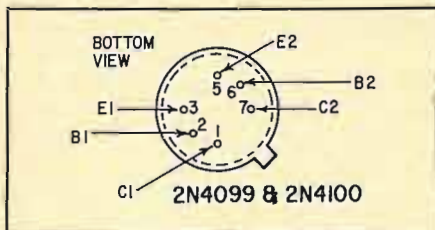

ers. The transistors feature very high dc gain, low noise, close parameter match and good thermal tracking.

Maximum ratings

	2N4099	2N4100
Diss. at 25°		
Each side	0.3W	0.4W
Both sides	0.5W	0.75W
V_{CE0}	55	55
V_{CE1}	55	55
V_{EBO}	7	7
I_C	10 mA	10 mA
T_J	200°C	200°C

Matching characteristics

	Max.
h_{FE1}/h_{FE2}	1.0
$V_{BE1} - V_{BE2}$	5 mV
$I_{B1} - I_{B2}$	10 nA
$\Delta(V_{BE1} - V_{BE2})$	5.0 μ V/°C
$\Delta(I_{B1} - I_{B2})$	0.5 nA/°C

The 2N4099 is in a TO-70 (6-lead TO-47) case. The 2N4100 is in a TO-78 (low-profile 6-lead TO-5) case. The base diagrams are shown.

CONTACTLESS SWITCH

The Photocom, a solid-state spst switch for low-level switching, consists of a neon lamp that drives a photoresistive cell. Ideal for use as a shunt or series modulator or chopper in operational amplifiers in ph meters, electrometers, servo controls and other applications where low-noise low-level

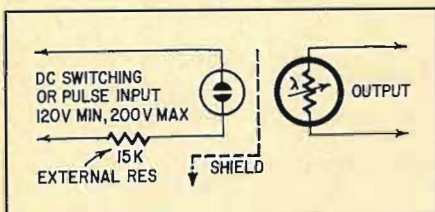

switching is needed. A typical dc and dc pulse drive circuit is shown. These units, made by James Electronics, are available as 10 types in two miniature resistorlike packages $\frac{3}{16}$ in. diameter and $1\frac{1}{8}$ in. long. The "A" package has five goldplated wire leads for easy PC mounting. The "B" package has 6-inch shielded output leads. Pertinent specifications for the C-4821 and C-4840 in the "A" package and the C-4825 and C-4841 in the "B" package are:

	C-4821	C-4840
	C-4825	C-4841
Drive volts	120	120
Drive pwr (mW)	500	500
Switching pwr (max mW)	50	50
On resistance (ohms)	5K-50K	10 ⁶
Off resistance (ohms)	10 ⁸	10 ¹¹
Turn-on time (msec)	0.75	0.75
Turn-off time (msec)	3	3
Insulation res (megs)	10,000	100,000

2N3950—50 WATTS AT 50 MHZ

This new transistor delivers at least 50 watts continuous power output at 50



MHz with minimum power gain of 8 dB. Designed for the power-output stage in solid-state vhf transmitters, the 2N3950 is rated for class-C operation but can also be operated class A or B in high-power SSB applications through 75 MHz.

This multiple-emitter transistor is in a grounded-emitter TO-60 package. Its data sheet, available from Technical Information Center, Motorola Semiconductor Products, Inc., Box 955, Phoenix, Ariz. 85001, includes such important design parameters as parallel equivalent input resistance and parallel equivalent input and output capacitance. The availability of these specifications simplifies the design of large-signal rf output stages, avoiding the usual trial-and-error methods. END

if you relax with records... Look for the ELPA Endorsement!



When you see the Elpa Seal of Endorsement on a component you can be assured that it is of highest quality and has successfully satisfied Elpa's stringent design and performance standards. THORENS superb turntables, ORTOFON cartridges, and CECIL E. WATTS record cleaning equipment all carry the Elpa seal and can be purchased with complete confidence. Write for the Elpa catalog, Dept. 9S1, Elpa Marketing Industries, Inc., New Hyde Park, New York 11040

THORENS / *Ortofon* / CECIL E. WATTS Ltd.



RADIO-ELECTRONICS READER'S SERVICE

Here's how you can get manufacturers' literature fast:

1. Tear out the post card on the facing page. Clearly print or type your name and address.
2. Circle the number on the card that corresponds to the number appearing at the bottom of the **New Products, New Literature** or **Equipment Report** in which you are interested.
For literature on products **advertised** in this issue, circle the number on the card that corresponds to the number appearing at the bottom of the advertisement in which you are interested. Use the convenient index below to locate quickly a particular advertisement.
3. Mail the card to us (no postage required in U.S.A.)

Advertisements in this issue offering free literature (see the advertisements for products being advertised):

AMPLIFIER CORP. OF AMERICA (Pg. 84)	Circle 109
BROOKS RADIO & TV CORP. (Pg. 88-89)	Circle 116
BROWNING LABORATORIES, INC. (Pg. 74)	Circle 37
BURSTEIN-APPLEBEE CO. (Pg. 74)	Circle 38
CASTLE TV TUNER SERVICE, INC. (Pg. 71)	Circle 34
CLEVELAND INSTITUTE OF ELECTRONICS (Pg. 1)	Circle 8
CORNELL-DUBILIER (Third Cover)	Circle 149
CORNELL ELECTRONICS CO. (Pg. 96)	Circle 124
DELTA PRODUCTS, INC. (Pg. 22)	Circle 19
DE VRY TECHNICAL INSTITUTE (Pg. 5)	Circle 9
EDMUND SCIENTIFIC CO. (Pg. 95)	Circle 122
ELECTRO-VOICE, INC. (Pg. 7)	Circle 11
ELPA MARKETING INDUSTRIES, INC. (Pg. 75)	Circle 40
FINNEY CO. (Pg. 17)	Circle 17
HEALD ENGINEERING COLLEGE (Pg. 91)	Circle 118
HEATH CO. (Pg. 24-25)	Circle 21
INTERNATIONAL CRYSTAL MFG. CO., INC. (Pg. 98)	Circle 148
JUDSON RESEARCH AND MFG. CO. (Pg. 85)	Circle 111
LAFAYETTE RADIO ELECTRONICS (Pg. 72)	Circle 35
MALLORY DISTRIBUTOR PRODUCTS CO. (Pg. 91)	Circle 117
MIKE QUINN ELECTRONICS (Pg. 86)	Circle 114
MULTICORE SALES CORP. (Pg. 86)	Circle 113
MUSIC ASSOCIATED (Pg. 84)	Circle 110

HELP THE EDITOR PLAN FUTURE ISSUES!!

At the bottom of the Reader's Service Card, you'll find numbers from 1 through 6. Read the following question and then circle your answers on the Reader's Service Card.

MY STRONGEST ELECTRONICS INTEREST IS IN:

(Circle appropriate numbers on RS card)

- 1 Audio/Hi-Fi/Stereo
- 2 Citizens Band/Two-Way Radio
- 3 Television
- 4 Transistors and Integrated Circuits
- 5 Industrial Electronics
- 6 Construction Articles

OLSON ELECTRONICS, INC. (Pg. 85)	Circle 112
OXFORD TRANSDUCER CO. (Pg. 66)	Circle 26
PERMA-POWER CO. (Pg. 79)	Circle 106
PIONEER ELECTRONICS U.S.A. CORP. (Pg. 16)	Circle 16
POLY PAKS (Pg. 97)	Circle 125
QUIETROLE CO. (Pg. 81)	Circle 107
RYE INDUSTRIES, INC. (Pg. 23)	Circle 20
S & A ELECTRONICS INC. (Pg. 27)	Circle 23
SAMS & CO., INC., HOWARD W. (Pg. 69)	Circle 30
SCIENTIFIC ASSOC. (Pg. 68)	Circle 28
SCOTT, H.H. INC. (Pg. 71)	Circle 100
SENCORE (Pg. 87)	Circle 115
SOLID STATE SALES (Pg. 95)	Circle 123
SONY CORP. OF AMERICA (Pg. 13)	Circle 13
SONY/SUPERSCOPE (Pg. 6)	Circle 10
SPRAGUE PRODUCTS CO. (Pg. 12)	Circle 12
SURPLUS CENTER (Pg. 92)	Circle 119
TEXAS CRYSTALS (Pg. 70)	Circle 31
TRIPLETT ELECTRICAL INSTRUMENT CO. (Second Cover)	Circle 7
TURNER MICROPHONE CO. (Pg. 73)	Circle 36
WARREN ELECTRONIC COMPONENTS (Pg. 94)	Circle 121
XCELITE, INC. (Pg. 14)	Circle 14

NEW PRODUCTS

More information on new products is available free from the manufacturers of items identified by a Reader's Service number. Turn to the Reader's Service Card facing page 76 and circle the numbers of the new products on which you would like further information. Detach and mail the postage-paid card.

Hz = hertz = cycles per second; kHz = kilocycles; MHz = megacycles



MAGNETIC TAPE SPLICER, model TS-6. The Cut-N-Splice has 3-position blade recessed in lever unit which closes on guide in which tape is secured. Built-in compartment contains 25 self-stick, cut-to-size splicing patches.—Robins Industries Corp.

Circle 46 on reader's service card

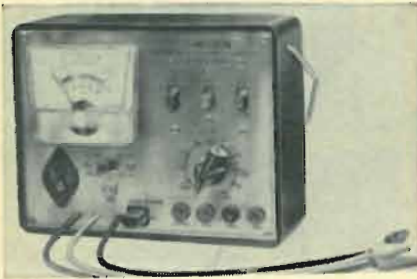

TRANSISTOR TESTER AND SET ANALYZER, model 1000. Designed to replace variety of test instruments. Checks germanium and silicon transistors; low- or high-power transistors; rf, i.f., audio transistors, whether pnp or npn types, and diodes. Checks dc gain to 400, transistor or diode leakage. Universal test socket. In-circuit, out-of-circuit testing. Three external leads for in-circuit testing.—Semi-tronics Corp.

Circle 47 on reader's service card



CB 2-WAY MOBILE RADIO, the Cobra V. Five channels. Transistorized.

Circuitry permits 100% voice modulation on transmit. Protective circuit for transmitter components. Solid-state switching device for automatic transmit/receive. Voltage filter. 12-volt dc battery, or 117 Vac accessory supply. Power input to

transmitter 5 watts. Frequency stability: $\pm .005\%$, antenna impedance 50 ohms nominal. Receiver sensitivity 0.5 μv for 10 dB signal-to-noise ratio; selectivity 6 dB at ± 3 kHz. Audio output 2.5 watts. Installs under dashboard of car or truck. 2 x 6 $\frac{1}{2}$ x 9 $\frac{1}{2}$ in., less than 5 lb.—B & K Div., Dynascan Corp.

Circle 48 on reader's service card

CAR STEREO TAPE-CARTRIDGE PLAYER, model TM706S. 8-track system. Solid-state chassis with 13 transistors, 1 diode. Dual-channel amplifier. Audio response: 50-10,000 Hz. Two 5 $\frac{1}{2}$ -in. speakers. Balance control, variable tone control. Cartridge inserts in front slot; plays

who says an old picture tube has to be DULL?

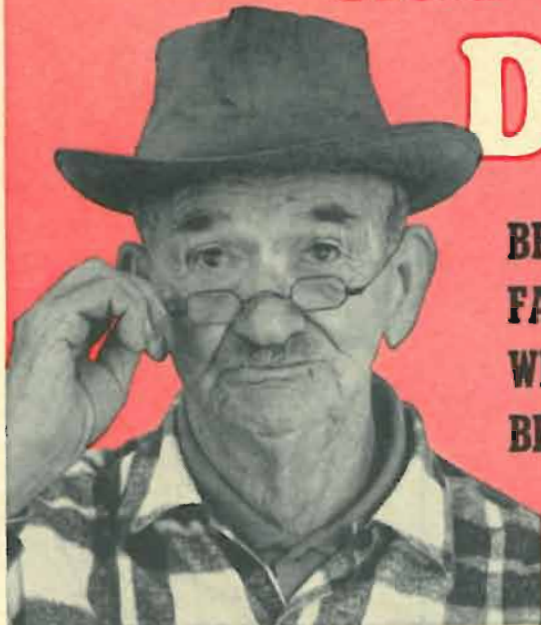

**BRIGHTEN UP THOSE
FADING PICTURES
WITH PERMA-POWER
BRITENERS!**



SQUINTING customers are unhappy customers. When aging picture tubes get dull, it's time for Tu-Brite. Tu-Brite instantly brings back like-new sparkle, and builds good will for you, even with the grouchiest old curmudgeon. *The right voltage is a cinch. If the base is right, the boost is right. No other britener gives you this assurance or ease of selection.*

Make sure you have all three models in stock.

Model C-202 for duodecal base CRT's.	Net
Model C-212 for 110° button base CRT's.	\$2.25
Model C-222 for 110° shell base CRT's.	each

Handsomely packaged for customer acceptance, color coded by base type for instant selection.

Write for free Britener Selector Chart, your guide to the base type of every picture tube now in the field.

PERMA-POWER COMPANY

5740 North Tripp Avenue • Chicago, Illinois 60646

Phone: 539-7171 (Area Code 312)

Circle 106 on reader's service card

4 easy ways to increase your know-how on microelectronics and solid state!

How to Build Tiny Electronic Circuits

By Morris Moses. Explains "miniaturized" electronics to the hobbyist, experimenter and service technician. Not only takes the mystery out of "making it smaller", but is a veritable "how to do it" of electronic miniaturization. Covers sub-miniaturization, microminiaturization, high-frequency receiver, molecular electronics, meter amplifiers, tone generators, semiconductor thermometers, making tools, preamplifiers, comparators, pocket radios, photorelays, components, techniques, modules, practical projects and devices, construction and repair hints. 192 pages.

Order #117 Softbound \$4.15

Getting Started With Transistors

By Louis E. Garner, Jr. Transistor know-how begins with this volume. Shows how transistors began, how to read electronic diagrams, how transistors work, facts on oscillators, transistor types, diodes, phototransistors, rectifiers, transistor ratings, testing transistors. Excellent text, diagrams and photographs carry you through every phase of transistors to give you a complete grasp of the subject. 160 pages by an expert in the field.

Order #116 Softbound \$3.95

Fundamentals of Semiconductors

By M. G. Scroggie. Provides a complete background in semiconductor devices, beginning with basic facts on electrical conduction through transistors, rectifiers, photoelectric devices, thermistors, varistors, diodes, cryosars, etc. Supplies enough theory in a simple way to make it possible to understand more advanced literature. Also explains how the special properties of semiconductors are being applied in many kinds of useful devices. Dozens of charts, diagrams and photos. 160 pages.

Order #92 Softbound \$2.95

Transistors

By Editors of Radio-Electronics. Carefully selected articles from Radio-Electronics combined in a unique handbook to show you how to build all-transistor test equipment, and how to test transistors. Clear, practical know-how on power transistor tester, direct-reading transistor tester, lab type checker, mini-tracer, TV bar generator, A-I-R generator, black box oscillator, scope calibrator, kilovoltmeter, etc. 96 pages.

Order #94 Softbound \$1.95

Order from your Parts Distributor or Mail to:

Gernsback Library Inc., Dept. RE 27
154 West 14th Street, N.Y., N.Y. 10011

Please send the following books. I enclose \$.....

117 (\$4.15) 116 (\$3.95)

92 (\$2.95) 94 (\$1.95)

Prices 10% higher in Canada.

Name

Address

City State Zip

My Distributor is



automatically and continuously until removed. Tape cartridge contains number of programs. Manual switching allows program selection. Operates with 12-volt negative-ground electrical systems. 8½ x 7½ x 3½ in.—Motorola Inc., Consumer Products Div.

Circle 49 on reader's service card



PAGING AND TALK-BACK SPEAKER, models DLC and DLC-T. Front-loaded compression cone driver with single reflex baffle. Mounting bracket adjustable over 180°. Power-handling capacity: 6 W (music power); frequency response: 400-10,000 Hz. Speaker provides 120° dispersion with sound-pressure level of 104 dB. Impedance: can be specified for 8 or 45 ohms. DLC-T has built-in matching transformer and adjustable power taps for 25- and 70-V lines. Speaker diameter 5½ in. Overall length of DLC, 4 in.; of DLC-T, 6½ in. Spun aluminum housing, baked acrylic finish.—University Sound

Circle 50 on reader's service card

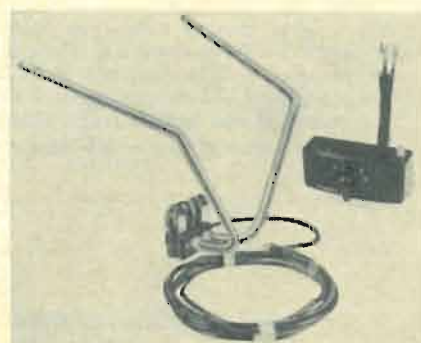

AUTO TV ANTENNA, model ATVIII. Spring-tension clamp attaches

80

on top edge of car window. Offset, omnidirectional V-dipole unit. Maximum signal on highway produced through 6-position picture clarifier. 10-ft shielded coaxial cable suppresses interference from ignition and motor. Triple-chrome plated brass construction. Nonferrous mounting bracket. Can also be side- or top-mounted to any horizontal or vertical part of a boat with special boat bracket.—JFD Electronics Co.

Circle 51 on reader's service card

PORTABLE GUITAR AMPLIFIER, model AM-299. Separate depth and speed controls for tremolo. Built-in jack for tremolo foot switch. Inputs for two guitars. 8-transistor circuit. 12 watts output.



Operates on 110-120 volts ac, 60 Hz or 8 "D" flashlight batteries. Leatherette finish. Controls on top of front panel. 13½ x 11½ x 5½ in.—Olson Electronics, Inc.

Circle 52 on reader's service card



HEAVY-DUTY ¼-IN. DRILL, Red Label model 710. UL-approved, industrially rated. 2.8-amp, 115-Vac power rating. Constant speed of 1,800 rpm. Oil-impregnated bronze sleeve bearings with ball thrust bearings on spindle. Electric motor with welded burnout-proof armatures. Pistol-type handle with trigger switch, die-cast aluminum housing. Geared Jacobs chuck with key. Locking trigger switch with safety release. 6-ft 3-wire cord and adapter. 8½ x 7¼ x 2½ in.—Wen Products, Inc.

Circle 53 on reader's service card

SOLID-STATE FM STEREO TABLE RADIO, model GR-36. Same tuner

RADIO-ELECTRONICS



and i.f. circuit used in deluxe Heathkit stereo components. Automatic switching to stereo with indicator light; adjustable phase control; fixed automatic frequency control; built-in agc; clutch-release volume control for independent or simultaneous adjustment of both channels; adjustable tone control; slide-rule dial; external antenna connectors. Two 5¼-in. PM speakers. Front-end factory assembled and aligned. Factory-built walnut cabinet. 19 x 9¼ x 6½ in.—Heath Co.

Circle 54 on reader's service card

SELF-AMPLIFIED SPEAKER SYSTEM, model 4400. Two walnut speaker enclosures. Each contains 8-in. woofer



and 3½-in. tweeter with crossover network. Enclosures acoustically matched to speakers. 60-W solid-state stereo power amplifiers built into one enclosure feeds both speakers. On-off volume control, bass-boost switch and stereo headphone jack. Works with any tape deck, preamplified tuner or phonograph. 16 x 14½ x 5 in.—Viking of Minneapolis

Circle 55 on reader's service card

VINYL PLASTIC ELECTRICAL TAPE, Scotch brand No. 35, for wire identification, color-coding and other ap-

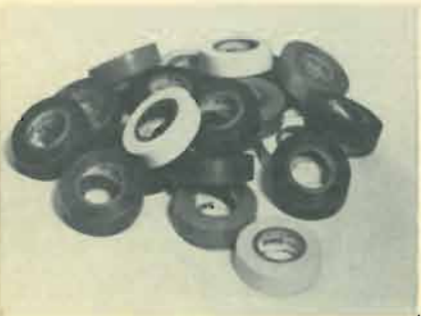

plications. Eight fadeproof colors: red, white, blue, yellow, green, orange, gray

and brown. 60-yd rolls on 3-in. core, slit to any width.—3M Co.

Circle 56 on reader's service card



SOLID-STATE STEREO PORTABLE, model VHP60, the Apartment. 9-in. duo-cone speaker, two 3½-in. tweeters in each speaker unit. 24-watt solid-state stereo amplifier. 4-speed, shock-mounted automatic/manual changer with automatic shutoff. Muting switch eliminates pickup noise during change cycle. 4-piece tubular tone arm. Ceramic cartridge, with flip-over dual-tip diamond stylus, floats in arm; to protect against record damage, cartridge retracts if tone arm is dropped. Speed control compensates for line-voltage variation; also varies pitch of recording. Accurate within 0.33%. Magnetic pickup-arm lock. Stereo headphone jack. Black vinyl-covered aluminum cabinet.—Radio Corp. of America.

Circle 57 on reader's service card

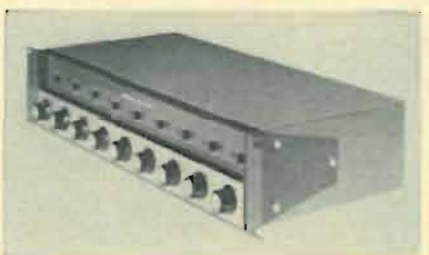

9-CHANNEL, SOLID-STATE MICROPHONE MIXER, model AM2A. Nine low-level inputs with low-impedance microphone preamp modules and booster amplifier. Other modules available for special applications. Input channels equipped with XLR microphone connectors, mixer control and speech-music switch. In "speech" position, frequencies below 300 Hz are attenuated in inverse proportion to frequency; reaches 18 dB at 50 Hz. Compatible with model AM1A mixer-amplifier to provide 15 individually controlled low-level inputs. Plugs and receptacles compatible with model AM50 power amplifier.—Langevin

Circle 58 on reader's service card



TUNABLE RF CONVERTER, the Tunaverter, model 1828. On-off switch

...JUST WHAT THE TV PROBLEM ORDERED!

QUIETROLE

- Lubricates and Cleans
- Apply With Spray or Dropper
- Non-inflammable . . . Non-conductive . . . Non-corrosive
- Harmless to plastics & metal — zero effects on capacity & resistance — "for color & black & white".

Quietrole is preferred by manufacturers and servicemen alike. Quiets noisy TV and radio controls. Mark-II for tuners, Spray-Pack for controls & switches, Silitron for general use.

At Your Distributor . . . Ask for Quietrole by Name.
manufactured by
QUIETROLE CO.
Spartanburg, South Carolina

Circle 107 on reader's service card

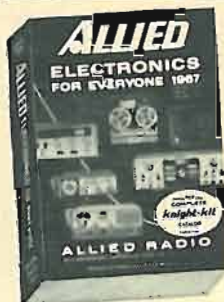

FREE
NEW 514-PAGE
1967
ALLIED
CATALOG

Top savings on the best in electronics for everyone

SAVE MOST ON:

- Famous Knight-Kits
- Stereo Hi-Fi
- Tape Recorders & Tapes
- CB 2-Way Radio
- Walkie-talkies
- FM-AM & AM Radios
- Short Wave & Ham Gear
- Portable TV & Phonos
- Intercom & P.A.
- Automotive Electronics
- Test Instruments
- TV Antennas & Tubes
- Power Tools, Hardware
- Tubes, Transistors
- Parts, Batteries, Books

Shop by mail and save at Allied, world's largest electronics headquarters. Hundreds of money-saving values, including fun-to-build Knight-Kits, and many specials available only from Allied. **NO MONEY DOWN! 24 MONTHS TO PAY!** Enjoy the things you want now, while you pay for them on the convenient Allied Credit Fund Plan.

Send for new 1967 ALLIED Catalog.

FREE!

ALLIED RADIO, DEPT. 2-B
P.O. BOX 4398, Chicago, Ill. 60680
 Send FREE 1967 ALLIED CATALOG

Name _____
PLEASE PRINT
Address _____
City _____ State _____ Zip _____

A free 10-day trial to prove you can solve any electronics problem with these 4 databooks and save \$5.00 in the process.

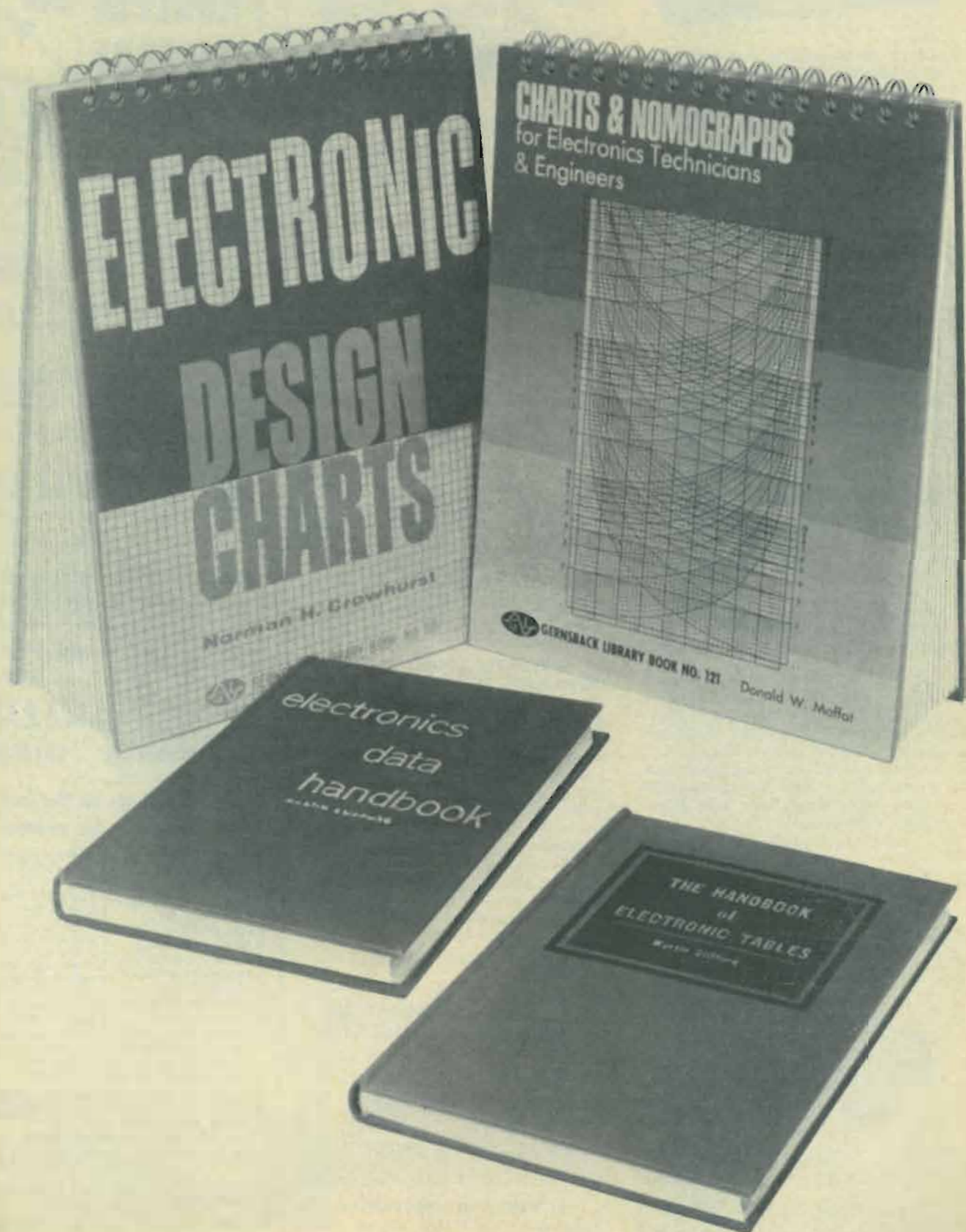

These four comprehensive databooks will put immediate answers at your fingertips to speed you through your projects faster and more efficiently. Now you will have instant answers—charts, nomographs, tables, formulas, key data—all engineered by specialists to meet your specific needs.

Here is the first place to look for authoritative answers to your toughest electronics problems—whether you are working with theoretical applications or practical projects. You focus quickly on the answers you want, reducing hours of figuring to seconds.

The great value of these databooks is in their organization. Every conceivable type of problem is covered. These books will never be out-of-date. You'll keep them at your elbow continually . . . to save time, effort and trouble.

Return the coupon and we will send you ALL 4 databooks for you to use for 10 days. There is no obligation. If you don't agree that these books are indispensable tools that you'll use for years to come . . . just send them back. What's more—if you take all 4 volumes—you may have them at the special money-saving combination price of only \$16.80—instead of the \$21.80 they cost if purchased individually. You save \$5.00.

Save an extra \$1.00.

Send your check or money order with your order for the complete set of 4 databooks. You save us billing costs, which we'll pass on to you. We pay postage and you deduct an extra \$1.00 off the combination price of \$16.80. (Same return privileges apply.)



◀ **CHARTS AND NOMOGRAPHS** by Donald W. Moffat. 96 pages of instant solutions to hundreds of electronics problems. Avoid tedious calculations that delay your work. Simply turn to the appropriate page, put your ruler in place and read off the correct answers for a whole family of solutions simultaneously. Large, stand-up, 8-1/2 x 11" format specifically designed for ease of use. Cloth bound. \$5.95 if ordered separately.

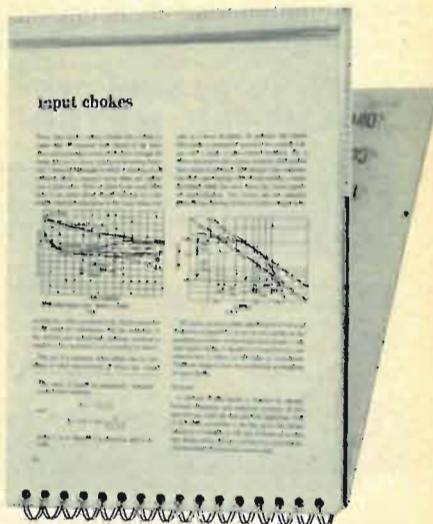

▶ **ELECTRONIC DESIGN CHARTS** by Norman H. Crowhurst. 128 pages—50 different charts give you more information in less time. Save hours of design . . . simplify design procedure . . . solve electronics problems quickly, and easily. Permanent spiral binding keeps large, 8-1/2 x 11" pages standing flat for ready reference. A valuable working tool for engineers and technicians. Cloth bound. \$5.95 if ordered separately.



▲ **ELECTRONICS DATA HANDBOOK** by Martin Clifford. 160 pages of the most needed electronics formulas and data gathered, arranged and coordinated for easy reference. An indispensable reference. Cloth bound. \$4.95 if ordered separately.



▶ **THE HANDBOOK OF ELECTRONICS TABLES** by Martin Clifford. A valuable new approach for accurate solutions to a wide range of electronics problems. This 160-page reference eliminates the need for mathematical computations, formulas, slide rules. All answers have been worked out for you in easy-to-use, accurate, electronic tables. Cloth bound. \$4.95 if ordered separately.

Save an extra \$1.00. Send payment in with order for all 4 Databooks. Deduct \$1.00 from \$16.80 price.

GERNSBACK LIBRARY, INC. Dept. RE 27,
154 West 14th Street, New York, N. Y. 10011

Send me the following Databooks for free 10-day trial

- ELECTRONIC DESIGN CHARTS \$5.95
- ELECTRONICS DATA HANDBOOK 4.95
- CHARTS AND NOMOGRAPHS 5.95
- HANDBOOK OF ELECTRONIC TABLES 4.95
- ALL 4 BOOKS AT THE MONEY-SAVING PRICE OF \$16.80
New York residents please add sales tax.

Enclosed \$ _____ Bill me _____
 Name _____
 Address _____
 City _____ State _____ Zip _____

THIS OFFER GOOD ONLY IN THE U.S. AND CANADA.

Assure 100%
**COMPLETE
ERASURE**
of Recorded Tape
ON THE REEL



Use the

Magneraser®

—the Original and still the best!

Quickly erases a reel of magnetic tape or sound film of any size or type. Erasure is 100% complete even on severely overloaded tape. Lowers background noise level of unused tape 3 to 6 db. Also demagnetizes record-playback and erase heads. Only \$24.00. Two-Year Guarantee. Available at your dealer's or write us.

New ULTRA-SENSITIVE FLUTTER METER



With built-in Three-Range Filter, 3 kc Test Oscillator, High Gain Pre-amplifier and Limiter. Filter Ranges: 0.5 to 6 cps; 0.5 to 250 cps; 5 to 250 cps.

Designed for rapid visual indication of flutter and wow. Meets standards set by the IEEE . . . Condensed Specs.:

Input Voltage, 0.001 to 300 Volts; Ranges, 0.01 to 3%; Limiter Range, 20 db.; Oscillator (built-in), 3000 cycles; Net Price, \$495.00 Write for complete specifications and free 12-page booklet on Flutter.

AMPLIFIER CORP. of AMERICA
75 Frost St., Westbury, N. Y. 11590 • (516) 333-9100

Circle 109 on reader's service card

Enjoy the "music-only" programs now available on the FM broadcast band from coast to coast.

- NO COMMERCIALS •
- NO INTERRUPTIONS •



It's easy! Just plug Music Associated's Sub Carrier Detector into multiplex jack of your FM tuner or easily wire into discriminator. Tune through your FM dial and hear programs of continuous commercial-free music you are now missing. The Detector, self-powered and with electronic mute for quieting between selections, permits reception of popular background music programs no longer sent by wire but transmitted as hidden programs on the FM broadcast band from coast to coast. Use with any FM tuner. Size: 5½" x 9". Shipping weight approx. 7 lbs.

KIT \$49.50

(with pre-tuned coils, no alignment necessary)

WIRED \$75.00 (Covers extra \$4.95 ea.)

Current list of FM Broadcast stations with SCA authorization \$1.00

MUSIC ASSOCIATED

65 Glenwood Road, Upper Montclair, N. J.
Phone: (201)-744-3387 07043

Circle 110 on reader's service card

NEW PRODUCTS continued

automatically switches any AM radio from broadcast to aircraft reception. 6-to-1 planetary reduction tuning; dial calibrated from 118–128 MHz. All-transistor; self-contained 9-volt battery; 24-in. connecting coax cable and swing mount. 2¼ x 3½ x 4¼ in. Other models for police, fire, amateur, marine.—Herbert Salch & Co., Marketing Div. of Tompkins Radio Products

Circle 59 on reader's service card



ETCHED-CIRCUIT KITS, for experimenters or students. ¼-in. thick copper-clad XXXP paper-base phenolic or G-10 glass-epoxy laminate panels, etching and development solutions, tools and accessories. Each kit demonstrates a different technique of circuit-board production. Model P101A is illustrated.—Kepro Circuit Systems, Inc.

Circle 60 on reader's service card

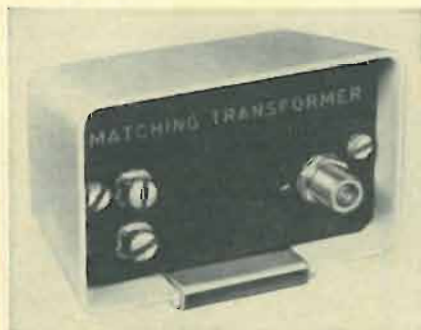

MAST-MOUNTED MATCHING TRANSFORMER, model 1002A, for master TV and home TV systems. Matches 300-ohm antenna lead to 75-ohm coaxial cable. Insertion loss: 0.8 dB maximum over 50–220 MHz. Uses MF 61A and MF 59A connectors. Kit available with model T-15 receiver matching transformer. 1½ x 4 x 2 in., ½ lb.—Craftsman Electronic Products, Inc.

Circle 61 on reader's service card

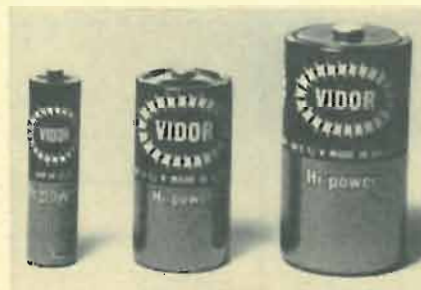

HIGH-POWER DRY CELLS, models HP2, (size D) HP11 (size C) and

HP14 (size AA), for use wherever relatively high current is required for long periods and voltage stability is important. 1½ V.—IRC, Inc.

Circle 62 on reader's service card

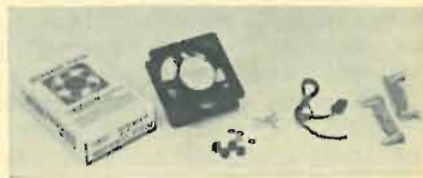

HI-FI FAN, the Hi-Fi Boxer. Low-noise fan provides enough air to flush average cabinet 10–20 times per minute. Minimizes thermal drift; improves component life. Metal housing. Aerodynamically efficient 5-blade design. Fits any cabinet. Mounting kit contains vibration-damping mounts, brackets, cord set, other hardware and instructions.—IMC Magnetics Corp.

Circle 63 on reader's service card



COLOR-BAR CONVERGENCE GENERATOR, model X-100. Pushbutton selector switches. Two sets of NTSC-type color-bar patterns: colors—red, blue and green; yellow, magenta and cyan. Additional patterns: crosshatch, 20 vertical lines, 15 horizontal lines for convergence adjustments. Perfect squares for linearity adjustments. Horizontal lines adjustable from double- to single-line thickness. Small and uniform dot pattern. Solid-state circuit. Crystal-controlled, 3.58-MHz color signal, 315-kHz oscillator for positive sync stability and timing stability. Color video control to check color-sync circuits and adjust signal output. Blank raster at minimum color-video control setting. Video output to bypass tuner and i.f. circuit. Rf output on channel 3 or 4 controlled with slide switch on front panel, adjustable for channel 5; feeds directly into antenna. Line isolated. Lead piercing clips. Power requirements: 117 V, 50–60 Hz, 7½ W. Leatherette and wood carrying case with compartment for cables.—Jackson Electrical Instrument Co., Inc.

Circle 64 on reader's service card

BACKGROUND MUSIC UNIT, model TD-125. Speakers added to unit make complete paging system. Solid-state 25-watt amplifier. Frequency response 50–15,000 Hz. Low-impedance, press-to-talk microphone mutes other signals;



eliminates need for paging relay. Auxiliary input for tuner or other program source. 2-hour, no-rewind tape cartridge slips into front. Controls (power switch, tape-cartridge lock, tone, volume and fuses) located on front panel. 11 x 13 x 6 $\frac{1}{2}$ in.—Bell P/A Products Corp.

Circle 65 on reader's service card

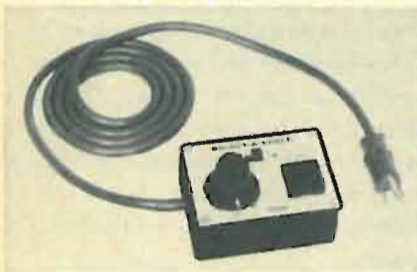

VARIABLE-SPEED CONTROL UNIT, the *Select-A-Speed*, for use with ac-dc motors up to 7 $\frac{1}{2}$ amp. Reduces speed of tool or appliance without reducing torque. Controls universal and brush type motors and heating elements from 0-100% of motor rpm. Dual-mode switch settings for full or variable speeds. In variable-speed mode, dial sets any speed from 0-70% rpm. Silicon controlled rectifier (SCR). Automatic built-in circuit breaker. Protective diode prevents damage to unit from transient voltages. Operates on 117 V; rated to 900 W. 6-ft cord, three-way plug.—Trans-Tek Manufacturing Co., Inc.

Circle 66 on reader's service card

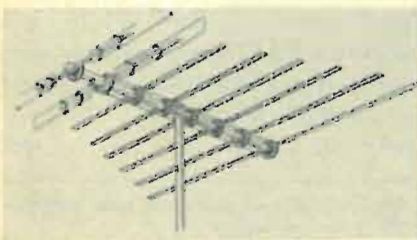

COLOR TV ANTENNAS, the *Para-log-Plus* series. Extra high gain provides sharp directivity. Flatness within ± 1 dB per channel avoids color distortion. Matched to both 300- and 75-ohm output to avoid color change. Parasitic elements combine 2 high-band directors in single director covering entire low band plus all FM channels. Driven elements work in 2 modes simultaneously: $\frac{1}{2}$ -wavelength

mode for low-band channels and $\frac{3}{2}$ -wavelength mode for high-band channels. Self-cleaning wedge snap locks. Cyolac insulators. Corrosion-resistant finish. Square boom construction. Grounded transmission lines. Eight models in series.—Jerrold Electronics Corp.

Circle 67 on reader's service card

COMPACT STEREO SYSTEM, model LSC-20. Transistorized amplifier. Volume and tone control for each channel; FM tuner input jacks; stereo headphone jack. Garrard 4-speed automatic record



changer. Automatic intermix of 7-, 10- and 12-in. records, automatic shutoff, dynamically balanced tone arm, wide-range stereo turnover cartridge and diamond stylus. 11-in. turntable, 45-rpm spindle. *Minulette/II* speaker systems each contain 5 x 7 in. woofer, 2 $\frac{1}{2}$ -in. tweeter and variable brilliance control. Full frequency range: 80-19,500 Hz. Operates on 117 V 60 Hz ac. Walnut wood cabinets. oil-finished. Control center: 19 $\frac{5}{16}$ x 14 $\frac{1}{4}$ x 3 $\frac{3}{4}$ in. Speaker enclosure: 6 x 15 $\frac{1}{2}$ x 9 $\frac{1}{16}$ in.—Lafayette Radio Electronics Corp.

Circle 68 on reader's service card

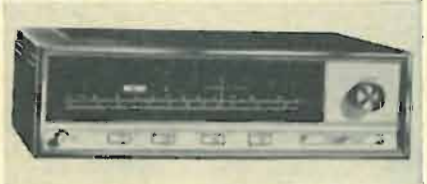

FM-AM TUNER, model S-2300. All-silicon transistors. Dual agc system maintains proper selectivity under strongest signal conditions—circuit utilizes both reverse and amplified forward control for agc. Noise-threshold-gated automatic FM stereo/mono switching; D'Arsonval zero-center tuning meter; front-panel level control. Rocker-action switches control interstation hush, automatic stereo/mono switching, FM-AM selection and power on/off. FM sensitivity: (IHF) 1.6 μ V for -30 dB noise and distortion below 100% mod. AM sensitivity: 2 μ V at 60% modulation for 6 dB signal to noise. Typical selectivity: FM, 250 kHz at -6 dB; 820 kHz at -60 dB. AM, 4 kHz at -6 dB. Stereo separation: 35 dB. FM capture ratio: 2.2 dB. FM stability: ± 10 kHz ($\pm 0.1\%$). FM crossmodulation rejection: 85 dB. FM distortion: less than 0.25% IM at 100% mod. (60 Hz/7 kHz; 4:1, std. pre-emphasis); less than 0.25% harmonic at 100% mod., 500 Hz. Hum and noise level: FM, 70 dB below 100% mod.; AM, 56 dB below 100% mod. 14 x 4 x 10 $\frac{1}{2}$ in., 10 $\frac{1}{2}$ lb.—Sherwood Electronic Laboratories, Inc.

Circle 69 on reader's service card

END

WE DON'T CLAIM
OUR ELECTRONIC
IGNITION SYSTEM
IS BEST . . .



OUR
CUSTOMERS DO!
WRITE TODAY FOR FREE LITERATURE

JUDSON
RESEARCH AND MFG. CO.
CONSHOHOCKEN, PA., U.S.A.

Circle 111 on reader's service card

Olson[®]



FREE

Fill in coupon for a **FREE** One Year Subscription to **OLSON ELECTRONICS' Fantastic Value Packed Catalog**—Unheard of **LOW, LOW PRICES** on Brand Name Speakers, Changers, Tubes, Tools, Stereo Amps, Tuners, CB, Hi-Fi's, and thousands of other Electronic Values. Credit plan available.

NAME _____
ADDRESS _____
CITY _____ STATE _____ ZIP _____

If you have a friend interested in electronics send his name and address for a **FREE** subscription also.

OLSON ELECTRONICS, INC.

564 S. Forge Street Akron, Ohio 44308

Circle 112 on reader's service card

**WORLD'S
FINEST
5-CORE
SOLDER**



**ERSIN
MULTICORE**

**NEW EASY
DISPENSER
PAK ONLY 69¢**

BUY IT AT RADIO-TV PARTS STORES

MULTICORE SALES CORP. WESTBURY, N.Y. 11590
Circle 113 on reader's service card

INTEGRATED CIRCUIT AND COMPUTER PARTS SALE

IC's TO-5 or All TO-46 Case, Gates, Flipflops, Buffers, etc. 100 Asstd. \$10.00
IC's Flat Packs same as above
100 Asstd. \$12.50
Above IC's sample tested over 50% good
Test information included.

IC's Tested 3 Input Gates, sim. 903 Choice TO-5 or TO-46 6 for \$2.95
Flatpack Flipflop Sim. 931 Tested 2 for \$2.95
Hi-Gain (Darlington) Amplifier TO-18 Similar 2N998, Tested 6 for \$2.95
Field Effect Trans. P Channel Similar 2N3277 TO-5 Tested. 3 for \$2.95
NPN H V, Hi Power Amplif., 20 Mhz 30 watts TO-59 stud, similar 2n2892 6 for \$2.95
Dual 6 lead TO-18 NPN or TO-5 PNP or NPN Diff. Amplif., Choppers, Dual Drivers. Sim. 2n 2980, 3726, 2060, Tested, choice 6 for \$2.95
Dual Computer Diodes 3 lead TO-18 case mostly Fast, common Anode Over 100 good \$3.95
Fast Switch, TO-52, sim. 2N3014, 914, tested 12 for \$2.95, 100 for \$15.00

NPN 5 watt 150V Small Power T052 Tested. Excellent Nixy or Neon Driver 6 for \$2.95
Microcleared Relay 3/8" sq. x 1 1/4". Ax. leads Norm. open 3000 ohm. Pick 6V, 3ma. 4 for \$2.95
Memory Plane 5 x 8" with 4000 wired toroid bits. \$9.75. Complete 8 plane unit \$75.00
GRAND MIX. Over 1000, 3,4,6,8,10 lead TO-5, TO-18, TO-46. Trans. Darl. IC's, FETs and a few diodes. Sample Tested 50-90% good \$19.50
Super SPECIAL. Select ANY combination of (6 for \$2.95) items only \$25.00 per 100.

Free GOODY bag with \$10 order.
Cash orders Postpaid.

COD's 25% deposit. Calif. sales 4% tax.

Postage Please for Amazing Free Catalog

MIKE QUINN ELECTRONICS

Bldg. 727 Langley Blvd.

Oakland Airport, California 94614

Circle 114 on reader's service card

NEW LITERATURE

All booklets, catalogs, charts, data sheets and other literature listed here are free for the asking with a Reader's Service number. Turn to the Reader's Service Card facing page 80 and circle the numbers of the items you want. Then detach and mail the card. No postage required!

CATALOG OF SWITCHES, Form SP-228, 8 pages, looseleaf-punched. Describes full line of rotary, pushbutton, lever and slide switches. Complete specs. Section of switch hardware.—Oak Electro/Netics Corp.

Circle 70 on reader's service card

RADIO, TV TEST EQUIPMENT BROCHURE, B & K Professional Test Equipment, 12 pages, looseleaf-punched. Features, specifications and prices of professional equipment for servicing radio, TV, hi-fi and electronic communications equipment.—B & K Div., Dynascan Corp.

Circle 71 on reader's service card

TOOL CATALOG, 56 pages, for electronic assembly and precision mechanics. Illustrations, index, ordering instructions.—Jensen Tools and Alloys.

Circle 72 on reader's service card

1967 SCIENTIFIC CATALOG, No. 671, 147 pages. Optical, mechanical, electrical and other science products. New, surplus and hard-to-find items. Ordering instructions, illustrations, index.—Edmund Scientific Co.

Circle 73 on reader's service card

1967 GENERAL CATALOG, 15 pages. Lists and describes new items, radio and TV tubes. Ordering instructions.—Cornell Electronics Co.

Circle 74 on reader's service card

MICROPHONE BOOKLET, Connecting the +2 to Your CB Set, 12 pages, pocket-size. Describes proper connections between the +2 microphone and more than 100 CB set models. Covers 30 brands of CB and amateur radio sets.—The Turner Co.

Circle 75 on reader's service card

SPEAKER CATALOG, No. 66, 8 pages, looseleaf-punched. PA, sound systems, hi-fi, automotive, radio-TV replacement. Descriptions, specs, illustrations.—Quam-Nichols Co.

Circle 76 on reader's service card

Write direct to the manufacturers for information on the items listed below:

ENGINEERING COLLEGE BULLETIN, 20 pages. Description of courses, tuition rates.—Heald Engineering College, Van Ness Ave. & Post St., San Francisco 9, Calif.

PLASTIC-SEMICONDUCTOR BOOKLET, bulletin SC-8999, 12 pages. Describes broad line of plastic-encapsulated devices. Characteristics, application advantages and typical uses for commercial, military and industrial purposes. Silicon and germanium bipolar and field-effect, unijunction and power transistors, and silicon rectifiers and IC's. Illustrations, diagrams.—Texas Instruments Inc., P.O. Box 5012, Dallas Texas. END

Two new "know-how" books you'll want to read.



Basic Oscillator Handbook

by Norman H. Crowhurst. A complete book on oscillators. When you need information on oscillators, you can stop hopping from book to book. This single volume makes you an oscillator expert. Basic Oscillator Handbook presents a fresh, clear-cut approach that you can understand and use immediately. Gives all the how's and why's of oscillators. 160 pages.

Order #130\$2.95

Test Instruments for Electronics

Edited by Martin Clifford in cooperation with the editors of Radio-Electronics. 24 experts tell you how to increase the efficiency and capabilities of your vom, vtm and scope. Teaches you how to build new, low-cost test instruments to supplement present equipment to extend their usefulness to perform tests you cannot do now. Test instruments for Electronics could be the most profitable \$2.95 buy you'll ever make just in terms of the time you'll save in one day's work.

Order #131\$2.95

Order from your electronic parts distributor today, or mail to:

Gernsback Library, Inc., Dept. RE267
154 West 14th Street, New York, N. Y. 10011

Send the following books:

- #130 (\$2.95)
 #131 (\$2.95)

I enclose \$..... (prices 10% higher in Canada)

Name

Address

City State Zip

My distributor is

Coming Next Month in MARCH

Radio-Electronics

One of the best magazine bargains of the year:
Our Special Issue on

Solid-State and Microelectronics

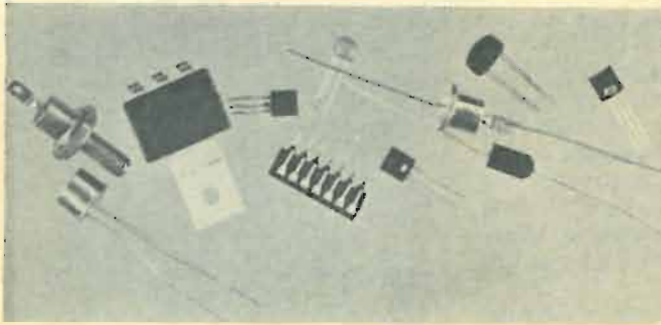

will show you . . .

- The easy way to put together circuits and stages around low-cost integrated circuits
- How to design your own transistor stages—a truly simplified way, with simple arithmetic
- Tricks of servicing the tiny television receivers that are beginning to abound
- A pair of high-power slave photoflash units you can build at considerable savings
- Where to find, how to use, and what to pay for inexpensive integrated circuits
- An intruder alarm to protect your automobile—one that's virtually break-proof
- How to increase the power of little CB walkie-talkie units with a simple final amplifier
- A new approach to calculations, based on the slide rule but easier to use and understand
- PLUS—A surprise announcement of something really new in the field of home entertainment

Make sure you get this valuable issue. Order your subscription or tell your distributor or newsstand dealer to save you a copy! On sale February 23.

The MARCH 1967 Special

Solid-State Microelectronics

Issue of **Radio-Electronics**

FEBRUARY 1967



TEST TRANSISTORS IN SECONDS in circuit

TR139
89⁵⁰



Also check all
transistors, diodes,
and rectifiers out
of circuit for true AC beta
and Icbo leakage.

Your best answer for solid state servicing, production line testing, quality control and design.

Sencore has developed a new, dynamic in-circuit transistor tester that really works—the TR139—that lets you check any transistor or diode in-circuit without disconnecting a single lead. Nothing could be simpler, quicker or more accurate. Also checks all transistors, diodes and rectifiers out of circuit.

BETA MEASUREMENTS—Beta is the all-important gain factor of a transistor; compares to the gm of a tube. The Sencore TR139 actually measures the ratio of signal on the base to that on the collector. This ratio of signal in to signal out is true AC beta.

ICBO MEASUREMENTS—The TR139 also gives you the leakage current (Icbo) of any transistor in microamps directly on the meter.

DIODE TESTS—Checks both rectifiers and diodes either in or out of the circuit. Measures the actual front to back conduction in micro-amps.

COMPLETE PROTECTION—A special circuit protects even the most delicate transistors and diodes, even if the leads are accidentally hooked up to the wrong terminals.

NO SET-UP BOOK—Just hook up any unknown transistor to the TR139 and it will read true AC beta and Icbo leakage. Determines PNP or NPN types at the flick of a switch.

Compare to laboratory testers costing much more. . . . **\$89.50**

See America's Most Complete Line of Professional
Test Instruments — At Your Distributor Now.



NO. 1 MANUFACTURER OF ELECTRONIC MAINTENANCE EQUIPMENT

SENCORE

426 SOUTH WESTGATE DRIVE, ADDISON, ILLINOIS 60101

Circle 115 on reader's service card

TRY THIS ONE

ROLLING UP TUNING STUB GIVES YOU "SECOND CHANCE"

In using a 1/4-wavelength trap made from a piece of twin-line to eliminate interference from a nearby transmitter, it can happen that as you cut-and-try the line becomes a little too short. A simple remedy for this is to roll up a bit of the trap section. Increased capacitance will then compensate for

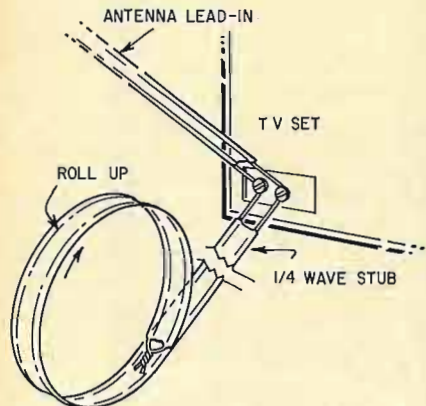

inadequate length. Tape the rolled-up line in place with cellophane tape.

You can also tell if the line should be shorter or longer by rolling some of it. If the interference gets worse with rolled-up line, the line definitely does not need to be longer.—Tom Jaski

SOLDERING CADDY FOR BENCH OR BOX

A soldering caddy that takes up little bench space is a handy for experimenters and technicians. This one was made from an empty beer can, cut to the approximate size shown with the edges rolled over and two notches made to hold a "pencil" type iron. A larger can may be used to hold a heavier soldering iron.

The bottom of the can is weighted for stability by pouring in some melted lead or by attaching a piece of scrap iron. The rest of the can is then packed with medium steel wool for cleaning the hot tip. Steel wool is much better for this than a dirty rag.



paper, hookup wire or a hank of solder. A coat of enamel hides the caddy's humble origin.—William H. Grace, Jr.

48th ANNIVERSARY SALE

AND OUR 20TH YEAR OF STEADY ADVERTISING IN RADIO-ELECTRONICS WITHOUT MISSING A SINGLE ISSUE — A WORTHY GUARANTEE OF VALUE & RELIABILITY—

FREE \$1 BUY WITH EVERY 10 YOU ORDER

Only applies to "\$1" Buys

FREE GIFT WITH EVERY ORDER

- | | | | |
|--|---|---|---|
| <input type="checkbox"/> 6—ELECTROLYTIC CONDENSERS \$1
10/10-450v, 80-200v, 50-60v ... | <input type="checkbox"/> 2 — G.E. 6X5GT TUBES \$1
brand new, individually boxed ... | <input type="checkbox"/> 4 — TV ALIGNMENT TOOLS \$1
most useful assortment ... | <input type="checkbox"/> 10—ASSORTED DIODE CRYSTALS \$1
1N34, 1N48, 1N60, 1N64, 1N82 |
| <input type="checkbox"/> 6—ELECTROLYTIC CONDENSERS \$1
20/10mfd - 350v, 80mfd - 50v ... | <input type="checkbox"/> 5—BONANZA "JACKPOT" not gold, not oil, but a wealth of Electronic Items—Money-Back-guarantee ... \$5 | <input type="checkbox"/> RCA 110° FLYBACK TRANSFORMER \$5

We scooped the Market Latest type — standard for all 110° TV's RCA's design of large Coil produces 18KV—assuring adequate width Incl Schematic Diagram application for any TV List price \$13.00 Your price .. \$3 10% off in lots of 3 | <input type="checkbox"/> 10—STANDARD TRANSISTORS \$1
NPN & PNP 2N404, 2N414, etc. |
| <input type="checkbox"/> 8 — ASST LUCITE CABINETS \$1
hinge cover, handy for parts ... | <input type="checkbox"/> 75'—MINIATURE ZIP CORD \$1
2 conductor, serves 101 uses ... | <input type="checkbox"/> 10—ASSORTED SLIDE SWITCHES \$1
SPST, SPDT, DPDT, etc. | <input type="checkbox"/> 25 — BENDIX CONDENSERS \$1
007-2000v \$15 value ... |
| <input type="checkbox"/> 100 — MIXED DEAL "JACKPOT" \$1
Condensers, Resistors, Surprises ... | <input type="checkbox"/> 10—ASSORTED SETS — DELUXE PLUGS & JACKS \$1
asst. for many purposes ... | <input type="checkbox"/> 10 — SETS PHONO PLUGS & PIN JACKS \$1
RCA type ... | <input type="checkbox"/> 10 — G.E. SAPPHIRE NEEDLES \$1
4G, VR-11, etc. (\$25.00 value) .. |
| <input type="checkbox"/> 1 — SQ. YARD GRILLE CLOTH \$1
most popular brown & gold design | <input type="checkbox"/> 10 — SURE-GRIP ALLIGATOR CLIPS \$1
2" plated ... | <input type="checkbox"/> 10 — RADIO & TV SOCKETS \$1
all type 7 pin, 8 pin, 9 pin, etc. | <input type="checkbox"/> 15 — G.E. #NE-2 TUBES \$1
Neon Glow Lamp for 101 uses .. |
| <input type="checkbox"/> 20 — EXPERIMENTER'S COIL "JACKPOT" \$1
assorted for 101 uses | <input type="checkbox"/> 50 — BUSS WIRE \$1
#20 tinned for hookups, special circuits, etc. ... | <input type="checkbox"/> 110° TV DEFLECTION YOKE \$3
for all type TV's incl schematic same as Thorlarsen Y502 list \$20 | <input type="checkbox"/> 2—G.E. PIECES OF EQUIPMENT \$1
stacked with over 200 useful parts |
| <input type="checkbox"/> 20—ASST. PILOT LIGHTS \$1
#44, 48, 47, 51, etc. | <input type="checkbox"/> 100 — STRIPS ASSORTED SPAGHETTI \$1
handy sizes ... | <input type="checkbox"/> COMBINATION SPECIAL — RCA 110° FLYBACK plus 110° DEFLECTION YOKE ... \$5 | <input type="checkbox"/> 5 — TOP HAT SILICON RECTIFIERS \$1
500ma-600v top quality ... |
| <input type="checkbox"/> 50 — ASST. DISC CERAMIC CONDENSERS \$1
popular numbers ... | <input type="checkbox"/> 100—ASSORTED RUBBER GROMMETS \$1
best sizes ... | <input type="checkbox"/> 90° FLYBACK TRANSFORMER \$2
for all type TV's incl schematic | <input type="checkbox"/> 1 — LB SPOOL ROSIN-CORE \$1
SOLDER 40/60 top quality ... |
| <input type="checkbox"/> 10 — ASST. RADIO ELECTROLYTIC CONDENSERS \$1 | <input type="checkbox"/> 50—ASSORTED PRINTED CIRCUIT SOCKETS \$1
best types ... | <input type="checkbox"/> 90° TV DEFLECTION YOKE \$2
for all type TV's incl schematic .. | <input type="checkbox"/> 3 — ELECTROLYTIC CONDENSERS \$1
popular number—50/30 150v |
| <input type="checkbox"/> 50 — ASST. TUBULAR CONDENSERS \$1
.001 to .47 to 600v ... | <input type="checkbox"/> 10—ASSORTED VOLUME CONTROLS \$1
loss switch ... | <input type="checkbox"/> 70° FLYBACK TRANSFORMER \$1
for all type TV's incl schematic | <input type="checkbox"/> 7 — ASST. TV ELECTROLYTIC CONDENSERS \$1
popular selection .. |
| <input type="checkbox"/> 20 — STANDARD TUBULAR CONDENSERS \$1
.047-600v ... | <input type="checkbox"/> 7—ASSORTED VOLUME CONTROLS \$1
with switch ... | <input type="checkbox"/> 70° TV DEFLECTION YOKE \$1
for all type TV's incl schematic | <input type="checkbox"/> \$15.00 TELEVISION PARTS \$1
"JACKPOT" best buy ever ... |
| <input type="checkbox"/> 3—1/2 MEG VOLUME CONTROLS \$1
with switch, 3" shaft ... | <input type="checkbox"/> 5 — ASST. SELENIUM RECTIFIERS \$1
65ma, 100ma, 300ma, etc. | <input type="checkbox"/> 20—ASSORTED TV COILS \$1
I.F. video, sound, ratio, etc. | <input type="checkbox"/> \$15.00 RADIO PARTS "JACKPOT" \$1
handy assortment ... |
| <input type="checkbox"/> CLEAN UP THE KITCHEN "JACKPOT" \$1
Big Deal only one to a customer ... | | <input type="checkbox"/> 40—ASSORTED TV KNOBS \$1
all standard types, \$20 value .. | |
| <input type="checkbox"/> 5 — ASSORTED TRANSFORMERS \$1
Radio, TV and Industrial ... | | | |

IMMEDIATE DELIVERY . . . Scientific light packing for safe delivery at minimum cost. HANDY WAY TO ORDER: Pencil mark or write amounts wanted in each box, place letter F in box for Free \$1 BUY. Enclose with check or money order, add extra for shipping. Tearsheets will be returned as packing slips in your order, plus lists of new offers.

Name Cost of goods
Address Shipping
..... estimated
..... TOTAL

Please specify refund on shipping overpayment desired: CHECK POSTAGE STAMPS MERCHANDISE (our choice) with advantage to customer

Circle 116 on reader's service card

INDICATOR FOR IGNITION CONTACTORS

A useful and inexpensive addition to resistance welders is a small neon lamp, connected across each pair of ignitrons, as diagramed.

With the welder at rest, the lamp serves as a warning light when power is turned on. During a weld, the lamp should go out completely to show that the tubes are conducting properly.

If phase-shift heat controls are used, the lamp should go out during weld time for 100% heat settings, glow dimly for high settings and more brightly for lower settings. If more than one heat setting is used, as with weld and post-heat operation, the change in

brightness of the neon lamp with the change in heat level indicates that controls are functioning properly.—*Eric Barschel*

TRANSISTOR KINK

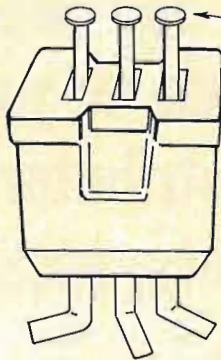

INSERT PINS IN SOCKET, BEFORE BENDING PRONGS AND SOLDERING.

In transistor construction projects, a lot of trouble can be caused by defective transistor sockets. This occurs when the lugs are bent before soldering. The pin sockets spread and don't make good contact with the transistor leads.

An easy way to avoid this trouble is to place an old transistor or (better) three ordinary straightpins in the socket before soldering. Then bend the lugs outward and solder.

Avoid too much or prolonged heat when soldering. It will soften the socket material and let the base, emitter and collector leads short.—*Joseph D. Amrose, K4IWW*

HANDY LIGHT-DUTY ANVIL



The sturdy construction of most speaker frames make them ideal as anvils for small forming and riveting jobs in the shop. The magnet housing generally has two rounded right-angled bends and two sharp right-angled bends, which can serve for various types of bending jobs.

The permanent-magnet and cone assembly may be removed and used for some other project. The makeshift anvil may be hung on a nail when not in use or it may be mounted permanently on the bench with suitable wood screws or bolts.—*Robert E. Kelland*

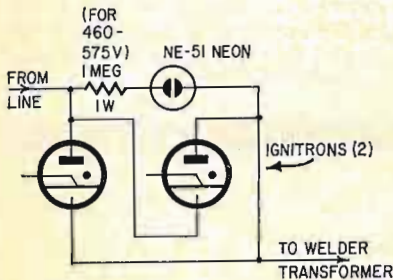

CANADIANS: Ordering is easy . . . we do the paperwork . . . try a small order

SARKES TARZIAN TV TUNER 41mc

Latest Compact Model—good for all 41 mc TV's.
BRAND NEW—MONEY BACK GUARANTEE

Best TUNER "SARKES TARZIAN" ever made—last word for stability, definition & smoothness of operation. An opportunity—to improve and bring your TV Receiver up-to-date.

COMPLETE with Tubes & Schematic . . . \$7.95

HIGHWAVE AM-FM PORTABLE RADIO



Elegance in Ebony & Chrome
14 Transistors — A Powerhouse of Quality Reception with AFC Operates on 4 "C" Cells
22" Telescoping FM Antenna & Personal Listening attachment
Money refund — if not better than any Known Brand selling for even twice the price
8" x 5 1/4" x 2 1/4" — 4 lbs

COMPLETE . . . \$19.50

IBM COMPUTER SECTIONS

8 assorted Units we sell for \$1 are loaded with over 150 valuable parts.
Incl. — Transistors, Condensers, Resistors, Heat Sinks, Diodes, Etc.

8 for \$1
100 for \$10

- | | | | |
|---|---|---|---|
| <input type="checkbox"/> 1000—ASST. HARDWARE KIT \$1
screws, nuts, washers, rivets, etc. | <input type="checkbox"/> HEARING AID AMPLIFIER \$2
incl. 3 Tubes, Mike, etc. (as is) | <input type="checkbox"/> 100—ASST 1/4 WATT RESISTORS \$1
stand. choice ohmages, some in 5% | <input type="checkbox"/> TAPE RECORDER — assorted types \$4
good, bad, broken, as-is, potluck |
| <input type="checkbox"/> 300 — ASSORTED HEX NUTS \$1
2/56, 4/40, 5/40, 6/32, 8/32 . . . | <input type="checkbox"/> UNIV. 3" x 5" PM SPEAKER 75¢
Best type for Radios, TV, Etc. . . | <input type="checkbox"/> 100 — ASST 1/2 WATT RESISTORS \$1
stand. choice ohmages, some in 5% | <input type="checkbox"/> \$4 ELECTRIC FOOT SWITCH \$1
deluxe type for any equipment . . |
| <input type="checkbox"/> 250—ASST. SOLDERING LUGS \$1
best types and sizes | <input type="checkbox"/> UNIVERSAL 4" PM SPEAKER 69¢
Alnico 5 magnet, quality tone . . | <input type="checkbox"/> 70 — ASST 1 WATT RESISTORS \$1
stand. choice ohmages, some in 5% | <input type="checkbox"/> TRANSISTOR RADIO <i>asst type</i> \$1.50
good, bad, broken, as-is, potluck |
| <input type="checkbox"/> 250—ASST. WOOD SCREWS \$1
finest popular selection | <input type="checkbox"/> 10 — SPEAKER PLUG SETS \$1
deluxe type, 2 conductor | <input type="checkbox"/> 35 — ASST 2 WATT RESISTORS \$1
stand. choice ohmages, some in 5% | <input type="checkbox"/> 6 — TRANSISTOR RADIO EAR-PIECES \$1
wired complete with plug |
| <input type="checkbox"/> 250 — ASST. SELF TAPPING SCREWS #6, #8, etc. \$1 | <input type="checkbox"/> CHAPT ZU DI MITZIA "JACK-POT" double your money back if not completely satisfied \$1 | <input type="checkbox"/> 50 — PRECISION RESISTORS \$1
asst. list-price \$50 less 98% | <input type="checkbox"/> 50 — ASSORTED MYLAR CONDENSERS popular selected types |
| <input type="checkbox"/> 150—ASST. 6/32 SCREWS and 150 6/32 HEX NUTS \$1 | <input type="checkbox"/> 300 — ASST. 1/2 W RESISTORS \$1
Top Brand, Short leads, excellent | <input type="checkbox"/> 20 — ASS'TED WIREWOUND RESISTORS, 5, 10, 20 watt \$1 | <input type="checkbox"/> TELEPHONE JACK or PLUG make any telephone portable ea \$50¢ |
| <input type="checkbox"/> 150—ASST. 8/32 SCREWS and 150—8/32 HEX NUTS \$1 | <input type="checkbox"/> 5 — I.F. COIL TRANSFORMERS \$1
sub-min for Transistor Radios | <input type="checkbox"/> 100 — ASST. MICA CONDENSERS some in 5% \$1 | <input type="checkbox"/> TELEPHONE RECORDING DEVICE instant suction cup fit \$1 |
| <input type="checkbox"/> 150—ASST. 2/56 SCREWS and 150—2/56 HEX NUTS \$1 | <input type="checkbox"/> 5 — AUDIO OUTPUT TRANSFORM Sub-min for Trans Radios \$1 | <input type="checkbox"/> 50 — ASST. TERMINAL STRIPS all types, 1-lug to 6-lug \$1 | <input type="checkbox"/> CRYSTAL LABEL MICROPHONE \$1
high impedance, 200-6000 cps . . . |
| <input type="checkbox"/> 150—ASST. 4/40 SCREWS and 150—4/40 HEX NUTS \$1 | <input type="checkbox"/> 4 — TOGGLE SWITCHES SPST, SPDT, DPST, DPDT \$1 | <input type="checkbox"/> 25 — INSTRUMENT POINTER KNOBS selected popular types \$1 | <input type="checkbox"/> 25' — MICROPHONE CABLE \$1
deluxe, 2 conductor, shielded |
| <input type="checkbox"/> 150—ASST. 5/40 SCREWS and 150—5/40 HEX NUTS \$1 | <input type="checkbox"/> 15 — ASST. ROTARY SWITCHES all popular types \$20 value \$1 | <input type="checkbox"/> 50 — ASST. RADIO KNOBS all selected popular types \$1 | <input type="checkbox"/> 50—TUBE CARTONS (colored) \$1
assorted sizes for Popular Tubes . . |
| <input type="checkbox"/> 500—ASSORTED RIVETS most useful selected sizes \$1 | <input type="checkbox"/> 70—BRASS FARNESTOCK CLIPS popular type & size, plated \$1 | <input type="checkbox"/> 5 — PNP TRANSISTORS general purpose, TO-5 case \$1 | <input type="checkbox"/> 10 — ASSORTED TUBES Radio, Television and Industrial . . \$1 |
| <input type="checkbox"/> 500—ASSORTED WASHERS most useful selected sizes \$1 | <input type="checkbox"/> 32'—TEST PROD WIRE deluxe quality, red or black \$1 | <input type="checkbox"/> 5 — NPN TRANSISTORS general purpose, TO-5 case \$1 | <input type="checkbox"/> ALL AMERICAN TUBE KIT Top Standard Brand — 12BA6, 12BE6, 12AV6, 50C5, 35W4 \$2 |
| <input type="checkbox"/> 100 — ASST. RUBBER & FELT FEET FOR CABINETS best sizes \$1 | | <input type="checkbox"/> 2 — POWER TRANSISTORS No. 1 Replace 2N155, 2N176, 2N301, etc. . . \$1 | <input type="checkbox"/> 5 — RCA 1U4 TUBES brand new \$ boxed, also serves as a 1T4 \$ |
| | | <input type="checkbox"/> 10 — ASST DUAL CONTROLS for Radio, TV, Hi-Fi, Stereo, etc. . . \$1 | |

BROOKS RADIO & TV CORP., 487 Columbus Ave., New York, N. Y. 10024

TELEPHONE 212-874 5600



Where's the first place to look for electronic ideas? See the Gernsback book rack at your local parts distributor for facts, tips, hints, answers & know-how!

When you need professional help on tough electronics problems, go directly to the Gernsback Library Book Rack at your favorite electronics parts distributor. Here you'll find answers on radio and TV servicing, transistors, hobby projects, test instruments, audio, hi-fi, stereo, tape recording, communications, industrial electronics, to name just a few areas. Each book is designed to give you practical assistance in the field you desire. Examine the recent titles below.



New Skill-Building Transistor Projects and Experiments

By *Louis E. Garner, Jr.* This unusual handbook helps you discover everything about transistors by actually doing things with transistors. Shows how to conduct experiments to gain new facts and prove key points. You'll assemble your own circuits, make your own tests, draw your own conclusions based on the knowledge you've acquired. Projects include: headphone amplifier, hi-fi preamplifier, power megaphone, cigar-box portable, electric eye, rain alarm, etc. 192 value-packed pages.

Order #129 Softbound \$2.95



Test Instruments for Electronics

Edited by *Martin Clifford*. Just the book for anyone who uses test equipment. Tells precisely how to increase the capabilities of vom's, vtvm's and scopes to perform tests that manufacturers did not build into the equipment. TEST INSTRUMENTS FOR ELECTRONICS also shows you how to build new test gear inexpensively that either isn't available commercially or is prohibitively priced. How-to hints help the technician in a big, time-saving way, too. A little ingenuity adds up to new capabilities for old test gear.

Order #131 Softbound \$2.95

Servicing AGC Circuits

By *Harry E. Thomas*. This practical how-to-do-it manual first shows you everything that can go wrong with AGC circuits and then goes on to reveal all you need to know to correct the trouble. Enables you to locate breakdowns quickly in AGC circuits, and then make your repairs rapidly and intelligently. Specific service approaches are plainly spelled out so you can use them immediately. Special emphasis is placed on TV troubleshooting, giving you the devices and techniques used in modern circuitry. Easy-to-read explanations, helpful illustrations. 204 pages, available through parts jobbers only.

Order #126 Softbound \$3.95



Basic Oscillator Handbook

By *Norman H. Crowhurst*. Now when you need information on oscillators, you can stop hopping from book to book in vain. This single book by famous author-engineer Norman H. Crowhurst tells you all you want to know about this subject. This clear-cut explanation of oscillators brings a new, fresh approach that you can understand and use immediately. This handy book teaches you all the how's and why's of oscillators... what they are, how they work, how to design them, how to use them, how to overcome their limitations. Definitely not a rehash of tired, wornout theory, but a new, clear explanation.

Order #130 Softbound \$2.95

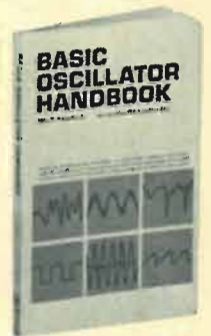

The Handbook of Electronic Tables

By *Martin Clifford*. Here is an effective new approach to solving electronics problems. You don't have to make mathematical computations, or carry a slide rule or memorize any formulas whatsoever. Every answer you will ever need is worked out for you in 160 fact-packed pages of accurate electronic tables. Simply take the figures of your electronics problems and turn to the appropriate table. Then move your finger across the table and read the answer, instantly. You'll find these tables are easy to use, offer a wide choice of solutions and provide a high degree of accuracy.

Order #125 Softbound \$2.95

Get These Books At Your Parts Distributor or Mail This Coupon

Gernsback Library Inc., Dept. RE 27
154 West 14th Street, New York, N.Y. 10011

Please send the books checked below. I enclose \$.....

(Prices 10% higher in Canada)

- 129 (\$2.95) 123 (\$2.95)
 130 (\$2.95) 125 (\$2.95)
 131 (\$2.95)

Name

Address

CityState.....Zip.....

My Distributor is

WHAT'S YOUR EQ?

These are the answers.
Puzzles are on page 43.

Zener Limiting Circuit

The applied voltage through the limiting resistors operates the Zeners at their rated voltages. Thus A is -10 volts with respect to ground—the sum of D1 and D3 voltages. Similarly, B is -30 volts with respect to ground—the sum of D2 and D3 voltages. Hence, a difference of 10 volts is found between A and B.

When the applied voltage is less than -20, the Zeners won't conduct, and practically zero volts will exist between A and B. Between -20 and -30 volts applied, D1 and D3 will conduct, while D2 won't. Voltage from A to B will vary between zero and 10.

Voltage Problem

Between A and B there is zero voltage. END

50 Years Ago

In **Gernsback Publications**
From **February, 1917**
Electrical Experimenter

United States and Japan Linked by Radio

Policing New York by Wireless
Low Potential Arc Transmitter for Radio Stations, by Gordon C. Farmer

Radio Proves How "News" Is Deleted,

A Horizontal Mineral Detector, by Robert S. Quimby

New Circuit for Undamped Wave Signal Radio, by Dr. Gordon M. Christine

The Design of Large Radio Receiving Transformers, by Chas. S. Ballantine

Multi-Mineral Duplex Point Detector Stand, by Bert Speicher

Up-to-Date Radio Amateur Switchboard, by H. C. Graham

English Women Learning Wireless
The How and Why of Radio Apparatus

Standard Radio Terms Defined

Dr. Nikola Tesla and His Achievements
The Kilbourne and Clark Radio System

Low-drain Solid-state tone signal needs no amplifier

The Sonalert® Signal makes it a cinch to rig all sorts of alarm circuits for the home, shop, auto or boat. Works with just about any triggering device, operates on 6-28 VDC, draws only 3-14 ma. 110-volt AC model draws only as much current as a neon pilot lamp.

It's completely solid-state. No arcing contacts, no RF noise. Highest reliability. Tone output is either 2800 or 4500 Hz, at 68 to 80 db.

Ask your Mallory Distributor for booklet of ideas, circuits, projects. Mallory Distributor Products Company, a division of P. R. Mallory & Co. Inc., Indianapolis, Ind. 46206.

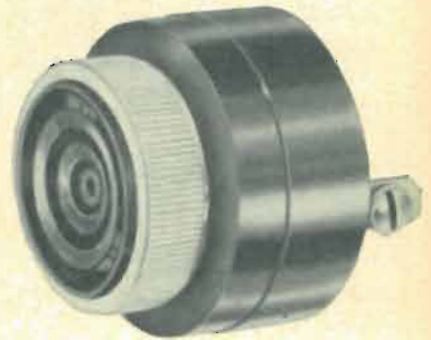

MALLORY

Circle 117 on reader's service card

Inexpensive Integrated Circuits

are the key to developing tiny electronic devices that do most of the jobs formerly done by larger solid-state units or tubes. There's a big list of low-cost IC's (and what you can use them for) coming

In March RADIO-ELECTRONICS

BIG CATALOG

World's "BEST BUYS" in GOV'T. SURPLUS Electronic Equipment

FULL OF TOP QUALITY ITEMS—

Transmitters, Receivers, Power Supplies, Inverters, Microphones, Filters, Meters, Cable, Keys, Phones, Antennas, Chokes, Dynamotors, Blowers, Switches, Test Equipment, Headsets, Amplifiers, etc., etc. SEND 25¢ (stamps or coin) for CATALOG and receive 50¢ CREDIT on your order. Address Dept. RE.

FAIR RADIO SALES

P.O. Box 1105 • LIMA, OHIO • 45802

ELECTRONICS

Engineering-Technicians

Bachelor of Science Degree, 30 Months
Save Two Years' Time

- Radio-Television Plus Color Technician (12 Months)
- Electronics Engineering Technology (15 Months)
- Electronics Engineering (B.S. Degree)
 - Electrical Engineering (B.S. Degree)
 - Mechanical Engineering (B.S. Degree)
 - Civil Engineering (B.S. Degree)
 - Architecture (B.S. Degree) (36 Months)



The Nation's increased demand for Engineers,

Electronic Technicians, Radio TV Technicians is at an all time high. Heald Graduates are in demand for Preferred High Paying Salaries. Train now for a lucrative satisfying lifetime career.

Approved for Veterans

DAY AND EVENING CLASSES

Write for Catalog and Registration Application. New Term Starting Soon.

Your Name
Address
City
State



1215 Van Ness Avenue
San Francisco, California

U.S. GOV'T ELECTRONIC SURPLUS

• Nationally Known-World Famous SURPLUS CENTER offers finest, most expensive, Government Surplus electronic units and components at a fraction of their original acquisition cost.

ORDER DIRECT FROM AG OR WRITE FOR CATALOGS

LABORATORY EXPERIMENTAL KIT

PERFORM 100'S OF FASCINATING ELECTRICAL EXPERIMENTS

Gov't Acquisition Cost Of Parts Over \$50.00

\$14.85
F.O.B.



- (ITEM #A222) - - Amazing Value! Valuable gift for son or husband. Hundreds of fascinating experiments. Teaches modern electronic theory and practice. 1 Ass. interesting way to learn.
- Experiment with electro-plating, electro-magnetic phenomena, resonance, burglar alarm, relay circuits, rectification, test circuits, caversdropping, motor experiments, transformer phenomena, etc.
- Kit Contains: DC motor, AC motor, electro-magnetic coils, ac and dc relays, set of capacitors, compass, test bulbs, plating chemicals, silicon diodes, germanium diodes, burglar alarm actuator, carbon microphone caversdropping element, ac test sockets, permanent magnets, telephone handset, cords, test clips, wire, and other items. Over 35 pieces. Includes fine Experimental Manual with drawings, procedures, etc., written by professional engineers.
- Also furnished with each kit our popular book Home Laboratory Bench and Experimental Procedures, (Reg. \$1.00). Shows how to build wonderful home laboratory test bench, and how to get the most out of your experimental work. (12 lbs.) Parts cost gov't over \$30.00.

AC PROGRAM TIMING CLOCK

• (ITEM #158) - - Zenith 113-V-AC program timer. Use for periodic signalling, work breaks, school classes, turn on call for newscasts, etc. Adjustable clips permit switching On or Off any time during 24-hour period. Sufficient clips for multiple programming. Also has "skip-a-days" feature. Contacts can handle up to 15 amps. 8 1/2" x 6 1/2" x 4". Wt. 8 lbs. Gov't Cost Over \$30.00.
Instructions Furnished. F.O.B. **\$9.49**



AUTO-PILOT GYROSCOPE

• (ITEM #115) - - DC motor driven, airmail mounted gyroscope. Ultra-expensive precision unit used to "steer" large, multi-engine planes. Deviation from established plane sends potentiometer controlled signals to bring about change in other motors. This can be used as auto-pilot for boats. Wonderful class room unit to demonstrate and study gyro action. Missiles, planes, boats all use gyros. Size 9" x 8" x 10". Wt. 21 lbs. Cost gov't over \$300.00.

STANDARD DIAL TELEPHONE

• (ITEM #716) - - Standard, commercial telephone same as used throughout U.S.A. Attractive polished black, like new condition. Extension phone to private systems or connect several phones together for local intercom system. Full instructions are furnished. Wt. 9 lbs. Original Cost \$24.50. F.O.B. **\$5.95**



STEP-BY-STEP AUTOMATIC SWITCH

• (ITEM #738) - - Amazing "up-and-around" electro-magnetic telephone switch. Dial any bank pair from 1 to 100. Make your own telephone system. Can also be used to remotely control up to 100 circuits over a single pair of wires.
• One of our FOUR 8" X 1" bargains. Comes complete with dial, one line bank. Size 5" x 7" x 15". Wt. 16 lbs. Cost Gov't Over \$75.00. Complete: Switch, cover, dial, line bank. Instructions..... F.O.B. **\$9.95**



STEP UP/DOWN TRANSFORMER

• (ITEM #1543) - - Step voltage up or down. Has many uses. Will step 115-volts up to 230-volts or step 230-volts down to 115-volts. Will also transform 115-volts to 25-volts. Rated 1.73 amps. output with 175-watt capacity. Size... 4 1/2" x 3 1/2" x 2". Wt. 4 lbs. Gov't Cost \$12.75. F.O.B. **\$4.99**

TYPICAL BUYS FROM OUR 1967 CATALOGS

- \$ 350.00 - Geared 2-hp Battery Golf Car Motor **\$24.95**
- \$ 15.00 - Westinghouse DC Ammeter, 0 to 300 **\$ 7.11**
- \$ 40.00 - Vacuum/Pressure Pump, 12-VDC **\$11.95**
- - - 80-MW Walkie-Talkies, Per Pair **\$19.60**
- - - DeLuxe, Multi-Range, AC/DC Tester **\$ 8.98**
- \$4000.00 - Carrier Telephone Amplifier System **\$13.91**

SPECIAL SALE

Correspondence Course In ELECTRICAL ENGINEERING

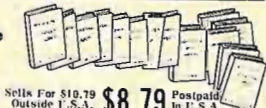

Sells For \$10.79 Outside U.S.A. **\$8.79** Postpaid in U.S.A.

- (ITEM #A181) - - Wonderful chance to obtain technical training at Amazing Low Cost! Lincoln Engineering School has suspended its Correspondence Courses because of increased operating costs. We offer a limited number of the school's complete Electrical Engineering Course but without the examination paper grading service. The course consists of 14 lesson unit books. Each book has the regular exams, and in a separate section, "Standard Answers" to each exam question.
- Course is well written, easy to understand, profusely illustrated. Reader's Digest size, easy to carry and study in spare time. Many Lincoln Engineering School students holding excellent jobs as a result of L.E.S. training. Course contains latest information on transistors, silicon diodes, etc. Additional book on how to build and operate a "Home Laboratory and Experimental Bench" furnished with each course.

SEND 25c COIN OR STAMPS FOR 3 MAIN CATALOGS

All Items FOB Lincoln Money Back Guarantee

SURPLUS CENTER

DEPT. RE-027 LINCOLN, NEBR. 68504

NOTEWORTHY CIRCUITS

INTERCOM REMOTE WILL SIGNAL MASTER

On many simple intercoms and radio-intercom combinations, the remote stations cannot call the master when the volume is turned down or when the radio is being used. Here is a simple circuit that can be added to the system to permit the remotes to signal the master any time.

A simple battery and buzzer combination like that shown in the diagram is installed in each remote-speaker cabinet. Half the buzzer's magnet coil is connected in series with one of the speaker leads.

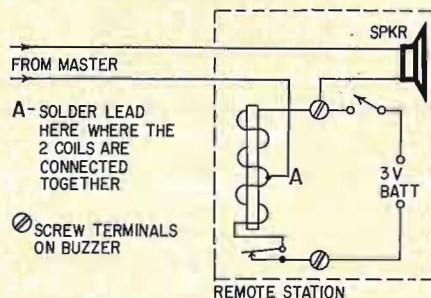

A - SOLDER LEAD HERE WHERE THE 2 COILS ARE CONNECTED TOGETHER

SCREW TERMINALS ON BUZZER

UNUSUAL DOORBELL EXTENSION

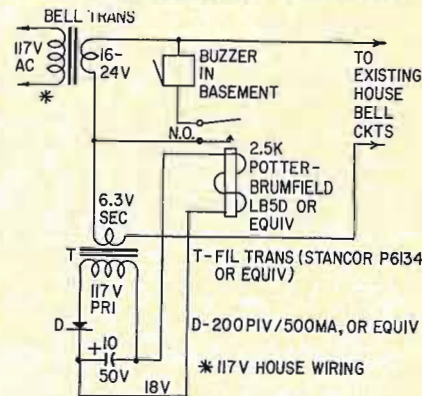

My problem was to install an extension doorbell in my basement workshop. This would have been simple but nearly all the wiring was buried in the walls. The only part of the system that was exposed was the bell transformer (in the basement) and the two low-voltage leads which disappeared in the wall.

The diagram shows the solution to the problem. I installed all the parts in a small metal box mounted close to the transformer.

When someone rings the doorbell, current flows through the secondary of the 6-volt filament transformer. The voltage across the primary (117-volt winding) is rectified and filtered and used to energize the relay which closes the circuit to the buzzer. This arrangement has worked well for several years and eliminated the need to "fish" wires through walls.—John Terrell END

—Willis C. Ware, Jr.



NEW BOOKS

ELECTRICAL AND ELECTRONICS DRAWING, by Charles J. Baer. McGraw-Hill Book Co., 330 W. 42 St., New York, N. Y. 10036. 6½ x 9½ in., 410 pp. Cloth, \$6.50

On electronics drafting. Everything from simple schematics through layouts for integrated-circuit devices. Appendices include terms, abbreviations, color codes, tables of equivalents, symbols. Done in a teach-yourself format, the book consists mainly of exact instructions for drawing all the different devices.

RCA LINEAR INTEGRATED CIRCUIT FUNDAMENTALS-DESIGN APPLICATION, Radio Corp. of America, Electronic Components and Devices, Harrison, N. J. 5½ x 8½ in., 240 pp. Paper, \$2.00

An extremely comprehensive, well-indexed manual on RCA IC's. Prefaced by a short section on design consideration for linear IC's, the book covers in close detail both operational- and differential-amplifier configurations. The last half of the book is given over to characteristics and applications of the 3000-series of low-cost RCA integrated circuits. Very technical, but packed with practical information, too.

YOUR FUTURE IN THE HIGH FIDELITY INDUSTRY, by Bernard Newman. Richards Rosen Press, Inc., 29 E. 21 St., New York, N. Y. 10010. 5½ x 8½ in., 128 pp. Cloth, \$4.00

Part of a series on careers, this book was conceived by the Institute of High Fidelity (IHF). The book is engagingly written and covers many facets of the high-fidelity industry. Entertaining as well as informative, but not technical. Good reading for anyone who wants to know more about every phase of the hi-fi industry. END

Solution to R-E Puzzler for January 1967

- | | |
|-------------------|----------------|
| 1 Synchronization | 13 Megacycle |
| 2 Magnetic | 14 Signal |
| 3 Solenoid | 15 Filter |
| 4 Conductor | 16 Coulomb |
| 5 Pentode | 17 Neutron |
| 6 Vernier | 18 Ampere |
| 7 Antenna | 19 Schematic |
| 8 Reactance | 20 Inductors |
| 9 Filament | 21 Headphone |
| 10 Terminal | 22 Component |
| 11 Fringe | 23 Harmonic |
| 12 Capacity | 24 Neutralizes |

25 Omnidirectional

Your rating:

- 60-64 Fair. 68-72 Good.
76-84 Better. 88-96 Even better.
100 Perfect! May we shake your hand?

By Edmund A. Braun

SCHOOL DIRECTORY

for a professional career

Tri-State graduates hold important engineering and business administration posts throughout the U. S. This professionally-oriented small college has outstanding placement record. Four-quarter year permits degree in three years. Excellent faculty. Well-equipped labs. Beautiful 300-acre campus. Accredited. Small classes. Modest costs. One-year. Drafting-Design Certificate program. Enter March, June, Sept., Jan. For Catalog, write Director Admissions indicating career interest.



TRI-STATE COLLEGE
2427 College Avenue, Angola, Indiana 46703

Learn Electronics for your SPACE-AGE EDUCATION at the center of America's aerospace industry

No matter what your aerospace goal, you can get your training at Northrop Tech, in sunny Southern California.

COLLEGE OF ENGINEERING. Get your B.S. degree in engineering in just 36 months by attending classes year round. Most Northrop Tech graduates have a job waiting for them the day they're graduated!

A & P SCHOOL. Practical experience on real aircraft. One-year course prepares you for F. A. A. A & P certificate. **WRITE TODAY FOR CATALOG.**

NORTHROP INSTITUTE OF TECHNOLOGY
1199 W. Arbor Vitae, Inglewood, Calif.



GET INTO ELECTRONICS

V.T.I. training leads to success as technicians, field engineers, specialists in communications, guided missiles, computers, radar and automation. Basic & advanced courses in theory & laboratory. Electronic Engineering Technology and Electronic Technology curricula both available. Assoc. degree in 29 mos. B.S. also obtainable. G.I. approved. Graduates in all branches of electronics with major companies. Start Feb., Sept. Dorms. campus. High school graduate or equivalent. Catalog.

VALPARAISO TECHNICAL INSTITUTE
Department C, Valparaiso, Indiana



LEARN Electronics Engineering AT HOME

Fix TV, design automation systems, learn transistors, complete electronics. College level Home Study courses taught so you can understand them. Earn more in the highly paid electronic industry. Computers, Missiles, theory and practical. Kits furnished. Over 30,000 graduates now employed. Resident classes at our Chicago campus if desired. Founded 1934. Catalog. Vets—write for information about GI Bill Training.

AMERICAN INSTITUTE OF ENGINEERING AND TECHNOLOGY
1139 W. Fullerton Pky., Chicago, Ill. 60614

Get Your First Class Commercial F. C. C. LICENSE

thru spare-time study by correspondence. Our money-back warranty protects your investment. (Approved for Veterans) Write for Brochure 67. It's free.

Grantham School of Electronics
1505 N. Western Av., Hollywood, Cal. 90027

TAKE YOUR PICK OF 253 COURSES

That's how many ways I.C.S. offers you to get ahead. No tricks. No gimmicks. Whatever your job interests—from accounting to zerography—there's an I.C.S. course for you. To help you get ahead faster in your present job... or find a new career. Write today for 3 FREE booklets: (1) "How to Succeed" career guide; (2) Famous Career Catalog; (3) Sample lesson to demonstrate the famous I.C.S. method, used by over 7,000,000 Americans since 1890. Send coupon NOW. No obligation.

INTERNATIONAL CORRESPONDENCE SCHOOLS

Dept. 42069A, Scranton, Penna. 18515

Accredited Member
National Home Study Council

Please send FREE success book, sample lesson and catalog checked.

- | | |
|--|---|
| <input type="checkbox"/> Accounting | <input type="checkbox"/> Elec. Eng'r/g |
| <input type="checkbox"/> Art | <input type="checkbox"/> High School |
| <input type="checkbox"/> Automobile | <input type="checkbox"/> Mech. Eng'r/g |
| <input type="checkbox"/> Business | <input type="checkbox"/> Radio-TV |
| <input type="checkbox"/> Languages | <input type="checkbox"/> Electronics |
| <input type="checkbox"/> Chemistry | <input type="checkbox"/> Secretarial |
| <input type="checkbox"/> Civil Eng'r/g | <input type="checkbox"/> Other—please specify |
| <input type="checkbox"/> Drafting | |

Name _____ Age _____

Address _____

City _____

State _____ Zip Code _____

New! WICS Package for Women!

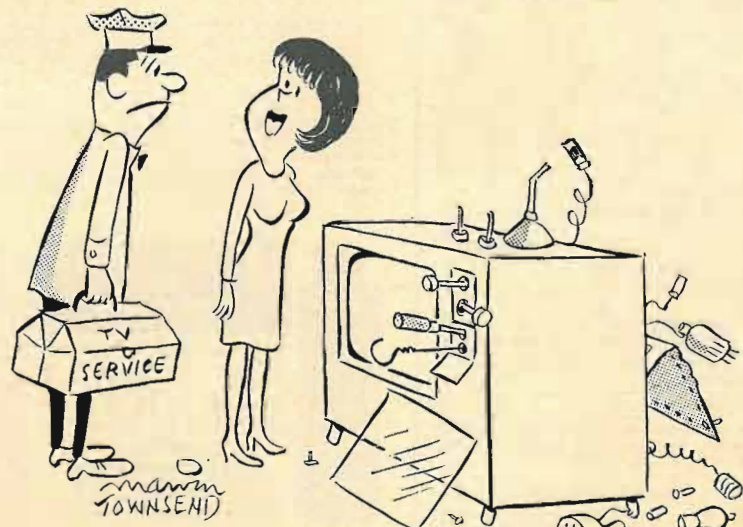

"This shouldn't take you long. Henry had the trouble almost licked when he had to leave for work."

MARKET CENTER

GENERAL

CONVERT ANY TELEVISION to sensitive Big-Screen Oscilloscope. Only minor changes required. No electronic experience necessary. Illustrated plans \$2.00. RELCO-A25, Box 10563, Houston 18, Texas

TV SERVICE ORDER BOOKS for use with your rubber stamp. Duplicate or triplicate. Low cost. Write for FREE 32 PAGE CATALOG and Special Rubber Stamp Offer. OELRICH PUBLICATIONS, 6556 W. Higgins, Chicago, Ill. 60656

FREE ELECTRONICS (new and surplus) Parts catalog. We repair multimeters. BIGELOW ELECTRONICS, Bluffton, Ohio 45817

PRINTING PRESSES, Type, Supplies. Lists 5¢. TURNBAUGH SERVICE, Mechanicsburg, Pa.

SILICON RECTIFIER SALE

IMMEDIATE DELIVERY
FULLY GTD NEWEST TYPE
AMERICAN MADE FULLY TESTED



750 MA-SILICON "TOPHAT" DIODES

LOW LEAKAGE FULL LEAD LENGTH

PIV/RMS 50/35 .05 ea.	PIV/RMS 100/70 .07 ea.	PIV/RMS 200/140 .10 ea.	PIV/RMS 300/210 .12 ea.
PIV/RMS 400/280 .14 ea.	PIV/RMS 500/350 .19 ea.	PIV/RMS 600/420 .21 ea.	PIV/RMS 700/490 .25 ea.
PIV/RMS 800/560 .30 ea.	PIV/RMS 900/630 .40 ea.	PIV/RMS 1000/700 .50 ea.	PIV/RMS 1100/770 .70 ea.

ALL TESTS AC & DC & FWD & LOAD

SILICON POWER DIODE STUDS

D.C. AMPS	50 PIV 35 RMS	100 PIV 70 RMS	150 PIV 105 RMS	200 PIV 140 RMS
3	.08 ea.	.12 ea.	.16 ea.	.22 ea.
12	.25	.50	.65	.75
35	.65	.90	1.25	1.40
50	1.00	1.20	1.50	1.75
100	1.60	2.00	2.40	3.00

D.C. AMPS	300 PIV 210 RMS	400 PIV 280 RMS	500 PIV 350 RMS	600 PIV 450 RMS
3	.27 ea.	.29 ea.	.37 ea.	.45 ea.
12	.90	1.30	1.40	1.65
35	2.00	2.35	2.60	3.00
50	2.20	3.25	3.50	4.00
100	3.60	4.50	5.25	7.00

"SCR" SILICON CONTROLLED RECTIFIERS "SCR"

PRV	7 AMP	16 AMP	25 AMP	PRV	7 AMP	16 AMP	25 AMP
25	.50	.75	1.00	250	1.75	2.15	2.50
50	.60	.90	1.25	300	2.00	2.40	2.75
100	.80	1.25	1.50	400	2.40	2.75	3.25
150	.90	1.60	2.00	500	3.20	3.40	3.80
200	1.25	1.80	2.25	600	3.40	4.00	4.50

SPECIALS! SPECIALS!
Westinghouse 160 AMP, 500 PIV SILICON HI-POWER
STUD RECTIFIER IN1666. Limited quantity. \$5.10 ea. 10 for \$45.00

100 Different Precision Resistors
1/2—1—2 Watt 1/2%—1% TOL \$1.25

Asst transistor Kit. P.N.P.—N.P.N.
All popular types. Unchecked 100 for \$2.95 500 for \$9.95

Computer Grade Condenser 15,500 MFD
12 VDC American Mfg. .75 ea.

Type IN34 DIODE GLASS .07 ea 100 for \$5

Money Back guarantee. \$2.00 min. order. Include
additional \$ for postage. Send check or money
order. C.O.D. orders 25% down.

Warren Electronic Components
230 Mercer St., N. Y., N. Y. 10012 • 212 OR 3-2620

New scientific transistor instrument detects buried coins, treasures. Will detect gold, silver, copper, iron, etc. \$19.95 up. Free catalog. RELCO-A-25, Box 10563, Houston 18, Texas

WANTED

QUICK CASH . . . for Electronic EQUIPMENT, COMPONENTS, unused TUBES. Send list now! BARRY, 512 Broadway, New York, N. Y. 10012, 212 WALKER 5-7000

INVENTIONS WANTED. Financial Assistance Free protection forms, information. Contact: INTERNATIONAL INVENTION INSTITUTE, Dept. 29, 160 Broadway, New York, N.Y. 10038

MERCURY, platinum, gold, silver. FREE circular. MERCURY REFINERS, Norwood, Mass.

WANTED: Radar Equipment AN/TPS-10D, APT-9, SCR-584, AN/GPG-1, M-33 etc., P. J. PLISHNER, 550 Fifth Avenue, N. Y. Tele: 212 JU 6-4691

TOY TRAINS BEFORE 1941. Trade Radios of 1920's. TED GENG, 28 Division St., New Brunswick, N. J. 08901

PROJECTION TELEVISION COMPONENTS WANTED. Need optic systems and projection tubes. State price and condition. J. KRIZSAN, 2519 Ashurst, Cleveland, Ohio 44118

WANTED: Name of manufacturer of Mark II Antibus Electronic Device. WILKEY-MOORE APPLIANCE CO., 118 S. Main, Wagoner, Oklahoma 74467

FARNSWORTH 10" table television GV-240, GV-250, GV-260. C. T. BROWN, 1004 Burr, Corona, Calif. 91720

AUDIO - HI-FI

RENT STEREO TAPES—over 2,500 different—all major labels—free brochure. STEREO PARTI, 1616-R Terrace Way, Santa Rosa, Calif. 95404

HI-FI COMPONENTS, Tape Recorders, at guaranteed "WE will not be undersold" prices. 15-day moneyback guarantee. Two-year warranty. NO Catalog. Quotations Free. HI-FIDELITY CENTER, 239R East 149th St., N.Y., N.Y. 10451

BLACK/WHITE
OR
COLOR

THE ONLY SAFE NON-DRIFT
TV TUNER
CLEANERS
AVAILABLE AT ALL DISTRIBUTORS

CHEMTRONICS

BROOKLYN, N. Y. 11236

ADVERTISING INDEX

RADIO-ELECTRONICS does not assume responsibility for any errors which may appear in the index below.

Allied Radio Corp. 81
Amplifier Corp. of America 84
Brooks Radio & TV Corp. 88-89
Browning Laboratories, Inc. 74
Burstein-Applebee Co. 74

Capitol Radio Engineering Institute, The . . . 62-65
Castle TV Tuner Service, Inc. 71

CLASSIFIED 94-97

Cleveland Institute of Electronics 1, 28-31
Conar (Div. of National Radio Institute) 70
Cornell-Dubilier Third Cover
Cornell Electronics Co. 96

Delta Products, Inc. 22
DeVry Technical Institute 5

Electro-Voice, Inc. 7
Electronic Measurement Corp. (EMC) 13
Elpa Marketing Industries, Inc. 75

Fair Radio Sales 91
Finney Co. 17

Gernsback Library Inc. 80, 82-83, 86, 90

Heald Engineering College 91
Heath Company 24-25

I.E.E.E. 16
International Crystal Mfg. Co., Inc. 98

Judson Research and Mfg. Co. 85

Lafayette Radio Electronics 72

Mallory Distributor Products Company
(Div. of P. R. Mallory & Co., Inc.) 91

Mike Quinn Electronics 86
Multicore Sales Corp. 86
Music Associated 84

National Radio Institute 8-11

Olson Electronics, Inc. 85
Oxford Transducer Company (A Division of
Oxford Electric Corporation) 66

Perma-Power Company 79
Pioneer Electronics U.S.A. Corporation 16
Poly Paks 97

Quietrol Co. 81

RCA Electronic Components and Devices
Test Equipment 15
Tubes Fourth Cover

RCA Institutes, Inc. 18-21
Rye Industries, Inc. 23

S & A Electronics Inc. 27
Sams & Co., Inc., Howard W. 69

Sarkes-Tarjian, Inc. (Tuner Service Div.) 26
Scientific Associates Corporation 68

Scott Inc., H. H. 71
Sencore 87

Solid State Sales 95
Sony Corp. of America 13
Sony/Superscope 6

Sprague Products Company 12
Surplus Center 92

Tarjian, Inc. Sarkes (Tuner Service Div.) 26
Texas Crystals (Div. of
Whitehall Electronics Corp.) 70

Triplett Electrical Instrument Company, The
Second Cover 73

Turner Microphone Company, The 73

United Radio Co. 97

Warren Electronic Components 94

Xcelite, Inc. 14

MARKET CENTER 94-97

Chemtronics
Edmund Scientific Corp.
TAB

SCHOOL DIRECTORY 93

American Institute of Engineering & Technology
Grantham School of Electronics
International Correspondence Schools
Northrop College of Science & Technology
Tri-State College
Valparaiso Technical Institute

TAPE RECORDER SALE. Brand new, latest models. \$10.00 above cost. **ARKAY SALES**, 1028-E Commonwealth Ave., Boston, Mass. 02215

WRITE for highest discounts on components, recorders, tapes, from franchised distributors. Send for FREE monthly specials. **CARSTON**, 1686-R Second Ave. N.Y.C. 10028

STEREO TAPES. Save up to 60% (no membership fees, postpaid anywhere USA). Free 60-page catalog. We discount batteries, recorders, tape accessories. Beware of slogans "not undersold," as the discount information you supply our computer is usually reported to the factory. **SAXITONE**, 1776 Columbia Road, Washington, D. C. 20009

TAPEMATES makes available to you ALL 4-TRACK STEREO TAPES—ALL LABELS—postpaid to your door—at tremendous savings. For free brochure write **TAPEMATES CLUB**, 5727 W. Jefferson Blvd., Los Angeles, Calif. 90016

HI FI Equipment At Dealer. Wholesale Cost. Catalog. **MACALESTER CORPORATION**, 355 Macalester, Saint Paul, Minnesota 55105

McGEE RADIO COMPANY. Big 1966-1967 catalog sent free. America's best values, hifi—amplifiers—speakers—electronic parts. Send name, address and zip code number to **McGEE RADIO COMPANY**, 1901 McGee Street, Dept. RE, Kansas City, Missouri 64108

HI-FIDELITY COMPONENTS, Ham Marine and Communication equipment at considerable savings. If you want to save money write us for our low prices on all your needs. **AIREX RADIO CORP.**, 132 (RE) Nassau St., New York, N.Y. 10038

BUSINESS AIDS

JUST STARTING IN TV SERVICE? Write for FREE 32 PAGE CATALOG of Service Order books, invoices, job tickets, phone message books, statements and file systems. **OELRICH PUBLICATIONS**, 6556 W. Higgins, Chicago, Ill. 60656, New Hyde Park 5, N.Y.

1,000 Business Cards, "Raised Letters" \$3.95 postpaid. Samples. **ROUTH**, 5717 Friendswood, Greensboro, N. C. 27409

DIAGRAMS, servicing information, Radio \$1.00, Television \$1.50. **BEITMAN**, 1760 Balsam, Highland Park, Illinois 60035

BUSINESS OPPORTUNITIES

TRAIN for solid high paying career in electrical repair. Experimental kits included. Free fact pack. I.T.I., Dept. 65033, 815 E. Rosecrans, Los Angeles, Calif. 90059

INVENTIONS-IDEAS developed: Cash/Royalty sales. Member: **UNITED STATES CHAMBER COMMERCE**, Raymond Lee, 130-U W. 42nd, New York City 10036

INVENTIONS NEEDED! Free analysis. Dependable service. Experienced personnel. **WALL STREET PROMOTIONS, INC.**, 99 Wall Street, New York, New York 10005

A large midwestern university is seeking an **ELECTRONICS TECHNICIAN**. Must be able to perform routine maintenance and repair of electronics, scientific equipment. Must have familiarity with both electron tube and solid state circuitry, and must be able to do design, construction, and modification of electronic circuitry. Apply Personnel Office, **UNIVERSITY OF MISSOURI AT KANSAS CITY**, 5100 Rockhill Road, Kansas City, Missouri

ELECTRONICS

BARGAINS in Canadian Electronic equipment and surplus. Send \$1.00 for giant catalogs. **ETCO**, Dept. R, 520 Fifth Avenue, New York 36, N.Y.

PROFESSIONAL ELECTRONICS PROJECTS — \$1 up. Catalog 25¢. **PARKS**, Box 25665A, Seattle, Wash. 98125

TUBES. "Oldies", latest. Lists free. **STEINMETZ**, 7519 Maplewood, Hammond, Indiana 46324

JAPAN & HONG KONG Electronics Directory. Products, components, supplies. 50 firms—just \$1.00. **IPPANO KAISHA LTD.**, Box 6266, Spokane, Washington 99207

SURPLUS SEMICONDUCTORS and miniature electronic parts. Send 25¢ for catalog. **ECD COMPANY**, P.O. Box 1432, Plainfield, N. J. 07061

TV CAMERA KITS for experimenters and industry. Expanded line includes monitors, vidicons, lenses, tripods, slow scan, etc. **NEW 1967 catalog**, 10¢. **ATV RESEARCH**, Box 396-R, So. Sioux City, Nebr. 68776

FREE Catalog. Electronic parts, tubes. Wholesale. Thousands of items. Unbeatable prices. **ARCTURUS ELECTRONICS RE**, 502-22 St., Union City, N. J. 07087

TV CAMERAS, converters, etc. Lowest factory prices. Catalog 10¢. **VANGUARD**, 196-23 Jamaica Ave., Hollis, N.Y. 11423

FREE CATALOG—Loads of electronic bargains. **R.W. ELECTRONICS, INC.**, 2244 So. Michigan Ave., Chicago, Illinois 60616

UNUSUAL BARGAINS

... MANY U. S. GOV'T SURPLUS

"Balls of Fun" for Kids ... Traffic Stoppers for Stores ... Terrific for Amateur Meteorologists ...

SURPLUS GIANT WEATHER BALLOONS



At last ... available again in big 8-ft. diameter! Create a neighborhood sensation. Great backyard fun. Exciting beach attraction. Blow up with vacuum cleaners or auto air hose. Sturdy enough for hard play; all over uses. Fill with helium (available locally) use balloons high in the sky to attract crowds, advertise store sales, announce fair openings, etc. Amateur meteorologists use balloons to measure cloud heights, wind speed, temperature, pressure, humidity at various heights. Photographers can utilize for low-cost aerial photos. Recent Gov't surplus of heavy, black, neoprene rubber.

Stock No. 60,568EH\$2.00 Ppd.

BATTERIES GUARANTEED RECHARGEABLE FOR 5 YRS.



Use these remarkable space-age Nickel-Cadmium batteries in flashlights, portable radios, toy or flash guns. Obsolete all others! Low-cost kit includes compact, highly efficient battery charger and 2 "D" size Ni-Cd batteries guaranteed rechargeable to full power for 5 yrs. Power output remains constant — doesn't fade away as with lead-acid cells. Durable, black plastic charger 5 3/4" x 3" x 1 3/4" dp, plugs into standard wall outlet. Completely charges 1 or 2 "D" or "C" size batteries in 16 hrs. Light shows when unit is charging — will not overcharge.

Stock No. 60,591EH\$9.95 Ppd.
Stock No. 60,592EH (Charger only)\$5.98 Ppd.
Stock No. 60,593EH (Two "D" Cells only)\$5.98 Ppd.

Order by Stock No. Check or M. O.—Money-Back Guarantee. **EDMUND SCIENTIFIC CO.**, Barrington, N. J. 08007

SEND FOR FREE CATALOG "EH"

Completely new 1967 edition. New items, categories, illustrations. Dozens of electrical and electromagnetic parts, accessories. Enormous selection of Astronomical Telescopes, Microscopes, Binoculars, Magnifiers, Magnets, Lenses, Prisms. Many war surplus items: for hobbyists, experimenters, workshop, factory. Mail coupon for catalog "EH".



NAME
ADDRESS
CITY STATE ZIP

CLIP AND MAIL COUPON TODAY

Circle 122 on reader's service card

INTEGRATED CIRCUITS ARE NOW AVAILABLE

15 Epoxy Rectifiers With Every \$5.00 Purchase. Many Over 600 PIV. No Shorts or Opens.

Silicon Power Rectifiers			
PRV	3A	20A	40A
100	.10	.40	1.00
200	.20	.60	1.50
400	.25	.80	2.00
600	.35	1.20	2.50
800	.45	1.50	3.00
1000	.65		3.50

5A Insul Base		Top Hat & Epoxy 750 MA	
PRV		PRV	
100	.20	100	.07
200	.40	200	.09
400	.60	400	.12
600	1.00	600	.20
800	1.25	800	.25
1000	1.40	1000	.50
1200	1.60	1200	.65
		1400	.85
		1600	1.00
		1800	1.20
		2000	1.35

Silicon Control Rectifiers					
PRV	7A	20A	PRV	7A	20A
50	.50	.80	400	2.10	2.85
100	.70	1.35	500	2.80	3.50
200	1.05	1.90	600	3.00	
300	1.60	2.45	700	3.50	

- "N" Channel FET'S SIM. to C-610 Used As Amp, Switch, Chopper—Very High Input Z Each \$1.50
- SIM. to 2N1640 (PNP) Bi-directional transistors. A to-5 silicon unit in which collector & emitter are interchangeable. Ea.\$.75
- SIM. to 2N728. A high frequency to-18 unit extending to the UHF range 5/\$1.00
- SIM. to 2N1648 (NPN) high voltage 40 Watt silicon unit, used in power output stages & power transistor drivers\$.75
- GLASS DIODES color coded. Silicon 20/\$1.00
6E 30/\$1.00
- SIM. to 2N995 (PNP). Silicon in to-18 case. 500 MW power, to 180 MHz frequency ... 4/\$1.00
- SIM. to 2N2875 (PNP). Silicon 20 watts with 30 MHz cut off\$.75
- 10 WATT ZENERS. 5-180V. State desired voltages Ea. \$.75
- SILICON BILATERAL SWITCH. Replaces two SCR's by firing in either direction when breakdown voltage is exceeded. Used in light dimmers, etc. 2/\$1.00
- GaAs VARACTORS, sim. to AP-1, AP-6, etc. 70 GHz at 150 MW. Ea.\$4.00
- 4" x 10" SPEAKERS. 10 Ω.
- 1.5 oz Magnet. Ea.\$2.50
- 6" x 9" SPEAKERS. 20 Ω.
- 1.5 oz Magnet. Ea.\$2.50
- 4" SPEAKERS. 3.2 Ω.
- 1 oz Magnet. Ea.\$1.25
- DUAL 1 MEG. POT. with off-on switch 4/\$1.00
- 455 KHz IF XRMRS 3/\$1.00
- 262 KHz IF XRMRS 3/\$1.00
- DUAL 20 μF at 350 V Electrolytics 3/\$1.00
- 28-101 P CERAMIC TRIMMERS 6/\$1.00
- NPN DUAL TRANSISTORS. A TO-5 package (2N2060) containing 2 high-gain 100 MHz silicon transistors\$1.50
- PNP DUAL TRANSISTORS. A TO-5 package (2N2807) containing 2 high-gain 100 MHz PNP transistors\$1.50
- HIGH-VOLTAGE NPN 150V VBCBO at 2.5A, gain of 100 in TO-3 package\$1.50
- HIGH-VOLTAGE ASSEMBLIES, 3000-6000V at 150-200 mA. \$2.00

These silicon assemblies may be put in series to achieve higher voltages.

Terms: FOB Cambridge, Mass. Send check or Money Order. Include Postage, Average Wt. per package 1/2 lb. Allow for C.O.D. Minimum Order \$20.00



POST OFFICE BOX 74 D
SOMERVILLE, MASS. 02143
SEND FOR FREE CATALOG

Name
Address
City State

MARKET CENTER

"COIL WINDING METHODS" Handbook—50¢. Experimenter's catalog 250 exclusive items—25¢, refundable. LABORATORIES, 12041-B Sheridan, Garden Grove, Calif. 92640

UNIQUE RELAY to build variety of remote controls, model railroads, liquid level control, weather detector, burglar alarm, games, trick circuits. 20 design ideas included free. \$3.95 prepaid. Dept. B, ALCO, Lawrence, Mass.

RECEIVING & INDUSTRIAL TUBES, TRANSISTORS, All Brands—Biggest Discounts, Technicians, Hobbyists, Experimenters—Request FREE Giant Catalog and SAVE! ZALYTRON, 469 Jericho Turnpike, Mineola, N.Y. 11501

GOVERNMENT SURPLUS

72 page illustrated Government Surplus Radio, Gadgets Catalog 25¢. MESMA, Nahant, Mass.

EDUCATION/INSTRUCTION

LEARN ELECTRONIC ORGAN SERVICING. New home study course covering all makes electronic organ including transistors. Experimental kits—schematics—trouble-shooting. Accredited NHSC-GI Approved. Write for free booklet. NILES BRYANT SCHOOL, 3631 Stockton Blvd., Dept. F, Sacramento 20, Calif.

"TAB" • SILICON ONE-AMP DIODES
Full Leads Factory Tested & Gd! U.S.A. Mfg

Piv/Rms	Piv/Rms	Piv/Rms	Piv/Rms
50/35	100/70	200/140	300/210
.05	.07	.10	.12
400/280	600/420	800/560	900/630
.14	.21	.30	.40
1000/700	1100/770	1700/1000	2400/1680
.50	.70	1.20	2.00

*All tests AC & DC & PWD & LOAD!

1700Piv/1200Rms @ 750Ma \$1.20 @ .10 for \$10
2400Piv/1680Rms @ 750Ma \$2 @ .6 for \$11

SILICON POWER DIODES - STUDS & P.F.**

D.C. Amps	50 Piv	100 Piv	200 Piv	300 Piv
	35 Rms	70 Rms	140 Rms	210 Rms
3	.10	.15	.22	.33
12	.25	.50	.75	.90
*18	.20	.30	.75	1.00
45	.80	1.20	1.40	1.90
160	1.60	2.90	3.50	4.60
240	3.75	4.75	7.75	10.45

"TAB" TERMS: Money Back Guarantee Our 22nd Year. \$2 Min. Add Shipping Charges
111 GF LIBERTY ST., N. Y. 6, N. Y.
Send 25¢ Phone: REctor 2-6245 for Catalog

"JAPANESE ELECTRONICS INDUSTRY" Monthly English Magazine. Sample \$1—Subscription \$10. DEE, 10639 Riverside, North Hollywood, Calif. 91602

RADIO & TV TUBES 33¢ each. One year guaranteed. Plus many unusual electronic bargains. Free catalog. CORNELL, 4217-E University, San Diego, California 92105

TRANSISTORS-DIODES — Components. Large selection. Write for FREE catalogue. ELECTRONIC COMPONENTS CO. Box 2902B, Baton Rouge, La. 70821

FREE CATALOG of 200 special slide rules and calculating aids. DYNA-SLIDE, 1566 Sherman Ave., Evanston, Illinois 60201

SOLDERING IRON
FAST HEAT 80 WATT
\$1.49

Special!
With every \$10 Order
25¢ per tube
(No Limit) from this list.
6AG5 6SN7
6AQ5 6CB6 6S4
6AU6 6J6 6W4

CORNELL TUBES
1 YR. GUARANTEED
Mutual Conductance Lab-tested. Individually Boxed, Branded and Code Dated. Tubes are new, or used and so marked.

21" PICTURE TUBES
39¢
No C.O.D. on Picture Tubes

all purpose ELECTRONIC CLEANER
89¢
ELECTRONIC CLEANER
LUBRICATES & PROTECTS

33¢ PER TUBE

100 TUBES OR MORE: **30¢ PER TUBE**

Prestige & Success are yours as an ELECTRONIC EXPERT
FOR CORNELL CUSTOMERS ONLY by special arrangement with the publisher, these amazing bargains are available.

COMPLETE RADIO SERVICING AND BASIC ELECTRONICS COURSE ONLY \$3.00 (12 30¢ + 30¢ shipping charges)

NEW PRACTICAL TV TRAINING COURSE ONLY \$3.50 (12 30¢ + 30¢ shipping charges)

Both above courses **\$6.00**

TUBE CARTONS
HIGH GLASS, CLAY COATED RED & BLACK WITH BUILT IN DIAGONAL PARTITIONS

TUBE SIZE	PRICE PER 10 CARTONS	PRICE PER 100 CARTONS
6A8	.29	2.59
6A5	.39	3.49
6A8B	.59	5.29
6A9S	.89	7.99

TV REFERENCE TRAPPER
EASY PERFECT TV RECEPTION

PICTURE EXPANDER
WIDER SCREEN

SILICON RECTIFIERS
750 MA 69¢ 1000 MA 89¢
400 P.I.V. 800 P.I.V.

DIODES/RECTIFIERS
sensational KIT VALUE

EPOXY DIODES
800 PIV 1000 MA 79¢
RATING ON EACH DEVICE

GIANT TWIN-PACK SELF STICKING PLASTIC ELECTRICAL TAPE
12,000 VOLT INSULATION
89¢

CAR RADIO POWER TRANSISTORS
No. 05801 99¢ No. 05802 69¢

CORNELL ELECTRONICS CO.
Dept RE 2 4217 University Ave., San Diego, Calif. 92105

TERMS: Add 3¢ per tube shipping. Orders under \$5.00 add 3¢ per tube shipping plus 50¢ handling. Canadian orders add approximate postage. Send 25¢ deposit on C.O.D. orders. No C.O.D. orders under \$5.00 or to Canada. No 24 hr. free offer on personal check orders. 5-DAY MONEY BACK OFFER.

Circle 124 on reader's service card

FCC LICENSE in 6 weeks. First Class Radio Telephone. Results Guaranteed. **ELKINS RADIO SCHOOL**, 2603E Inwood, Dallas, Tex.

SLEEP LEARNING. Hypnotism! Tapes, records, books, equipment. Details, strange catalog FREE. **RESEARCH ASSOCIATION**, Box 24-RD, Olympia, Wash.

BROADCASTING, Communications Electronics taught quickly—resident classes; correspondence. Free details. Write: Dept. 4, **GRANTHAM SCHOOLS**, 1505 N. Western, Hollywood, Calif. 90027

REI First Class Radio Telephone License in (5) weeks Guaranteed. Tuition \$295.00. Job placement free. **RADIO ENGINEERING INSTITUTE**, 1336 Main Street, Sarasota, Fla.

CORRESPONDENCE COURSES—B.Sc., Engineering, Electronics, Catalog \$1. **CANADIAN INSTITUTE OF SCIENCE & TECHNOLOGY**, 263E Adelaide St. W., Toronto

LEARN TECHNICAL WRITING—qualify at home for high paying prestige career not requiring college. Growing demand in all industries for tech writers now. Low monthly tuition. Easy to understand, FREE career book, sample lesson. **AMERICAN TECHNICAL WRITING SCHOOLS**, Dept. REC-27, 5512 Hollywood Blvd., Hollywood, Calif. 90028

WATCH REPAIRING. Learn to repair American and Swiss watches in spare time at home. Tuition \$5 monthly. Diploma awarded. Free sample lesson. No obligation. **CHICAGO SCHOOL**, Dept. REB, Fox River Grove, Illinois 60021

WANTED! TV-RADIOMEN to learn aircraft electronics servicing. Numerous job openings everywhere. Write: **ACADEMY AVIONICS**, Reno/Stead Airport, Reno, Nevada

DON'T BUY TUBES!! RADIO or T.V.-XMITTING or SPECIAL-PURPOSE TYPES

UNTIL YOU GET OUR PRICE LIST
GUARANTEED TO BE THE
LOWEST PRICES IN THE U.S.A.
OVER 5000 TYPES—ALL 100%
GUARANTEED BRAND NEW

"WE'RE NEVER UNDERSOLD"

SEND POST CARD FOR T.V. OR
SPECIAL PURPOSE PRICE LIST

ESTABLISHED 1920

UNITED RADIO CO.

56 FERRY ST., NEWARK, N.J.
P.O. BOX 1000 - ZIP CODE - 07101

SERVICES

Transistorized products dealers catalog. \$1.
INTERMARKET, CPO 1717, Tokyo, Japan.

CLASSIFIED COMMERCIAL RATE (for firms or individuals offering commercial products or services): 60¢ per word . . . minimum 10 words.

NON-COMMERCIAL RATE (for individuals who want to buy or sell personal items): 30¢ per word . . . no minimum.

Payment must accompany all ads except those placed by accredited advertising agencies. 10% discount on 12 consecutive insertions, if paid in advance. Misleading or objectionable ads not accepted. Copy for March issue must reach us before January 9th.

WORD COUNT: Include name and address. Name of city (Des Moines) or state (New York) counts as one word each. Zone or Zip Code numbers not counted. (We reserve the right to omit Zip Code if space does not permit.) Count each abbreviation, initial, single figure or group of figures or letters as a word. Symbols or groups such as 8-10, COD, AC, etc., count as one word. Hyphenated words count as two words. Minor over-wardage will be edited to match advance payment.

CLASSIFIED ADVERTISING ORDER FORM

For complete data concerning classified advertising please refer to box elsewhere in Market Center section.

1	2	3	4	5
6	7	8	9	10
11	12	13	14	15
16	17	18	19	20
21	22	23	24	25
26	27	28	29	30
31	32	33	34	35

No. of Words { @ .30 Non-Commercial Rate } = \$ _____
{ @ .60 Commercial Rate }

Total Enclosed \$ _____

Insert _____ time(s)

Starting with _____ issue

Payment must accompany order unless placed through accredited advertising agency 27

NAME _____

ADDRESS _____

CITY _____ STATE _____ ZIP _____

SIGNATURE _____

MAIL TO: RADIO-ELECTRONICS, CLASSIFIED AD DEPT., 154 WEST 14TH ST., NEW YORK, N.Y. 10011

ANNIVERSARY SPECIAL For **FREE!** 67

BONUSES

With Every \$5.00 Purchase, *
ads Only
CHOOSE \$1 ITEM FREE

Check Here

USE AS ORD-A-GRAM

New! 'PANCAKE' Transistors IN THE NEW TO46 MICRO CASES

☆ Silicon Epitaxial Planars ☆ 70% off retail
☆ Only 1/16" high ☆ Gold nvar leads ☆ Tested

Like	Watts	VCB [†]	HFE	mc	*Maximums
<input type="checkbox"/> 2N706	.4	20	20	200	4 For \$1 (NPN)
<input type="checkbox"/> 2N708	.36	20	30	480	
<input type="checkbox"/> 2N870	.5	60	120*	80	
<input type="checkbox"/> 2N1613	.8	50	120*	80	
<input type="checkbox"/> 2N1893	.8	100	120*	70	
<input type="checkbox"/> 2N2049	.8	50	300*	85	
<input type="checkbox"/> 2N2645	.5	50	300*	85	
<input type="checkbox"/> 2N2314	.4	60	50	150	
<input type="checkbox"/> 2N2434	.5	80	185	100	

ONE WATT ZENER 44¢

Volts	Volts	Volts
<input type="checkbox"/> 6.8	<input type="checkbox"/> 18	<input type="checkbox"/> 75
<input type="checkbox"/> 8.2	<input type="checkbox"/> 22	<input type="checkbox"/> 82
<input type="checkbox"/> 9.1	<input type="checkbox"/> 24	<input type="checkbox"/> 91
<input type="checkbox"/> 10	<input type="checkbox"/> 27	<input type="checkbox"/> 100
<input type="checkbox"/> 12	<input type="checkbox"/> 30	<input type="checkbox"/> 120
<input type="checkbox"/> 15	<input type="checkbox"/> 51	<input type="checkbox"/> 150
		<input type="checkbox"/> 180

\$1 HEADLINERS

TRANSISTORS,

<input type="checkbox"/> 10 PNP SWITCHING	\$1
<input type="checkbox"/> 10 NPN SWITCHING	\$1
<input type="checkbox"/> 15 PNP CK722, 2N107	\$1
<input type="checkbox"/> 15 NPN 2N35, 170, . . .	\$1
<input type="checkbox"/> 4 2N255 POWER 20-W	\$1
<input type="checkbox"/> 25 GERMANIUM . . .	\$1
<input type="checkbox"/> 25 TOP HAT'S RECT.	\$1
<input type="checkbox"/> 10 2-AMP RECTIFIERS	\$1

750 MIL TOP HAT AND EPOXIES

PIV	Sale	PIV	Sale	PIV	Sale
50	5¢	600	20¢	1400	85¢
100	7¢	800	25¢	1600	1.10
200	9¢	1000	50¢	1800	1.35
400	12¢	1200	65¢	2000	1.50

2-Amps "GLASSMIKE" SILICON RECTIFIERS

SILICON SCRS CONTROLLED RECTIFIERS

PIV	Sale	PIV	Sale
50	9¢	600	40¢
100	13¢	800	51¢
200	19¢	1000	69¢
400	29¢		

PRV	7 AMP	16 AMP	25 AMP
50	48¢	70¢	.90
100	70¢	1.20	1.50
200	1.05	1.70	2.10
300	1.60	2.20	2.70
400	2.10	2.70	3.00
500	2.80	3.30	3.80
600	3.00	3.90	4.30

WORLD'S MOST POPULAR \$1 PARTS PAKS

- 30 "YELLOW" MYLAR CONDENSERS, asstd. val \$1
- 60 CERAMIC CONDENSERS, discs, npo's, to .05 \$1
- 60 TUBULAR CONDENSERS, to .5mf, to 1Kv, asst \$1
- 40 DISC CONDENSERS, 27mmf to .05mf to 1KV \$1
- 60 TUBE SOCKETS, receptacles, plugs, audio, etc. \$1
- 30 POWER RESISTORS, 5 to 50W. to 24 Kohms. \$1
- 65 HALF WATERS, asst incl: A.B., 5% too! . \$1
- 60 HI-C RESISTORS, 1/2, 1, 2W, 1% & 5% values \$1
- 10 VOLUME CONTROLS, to 1 meg, switch too! \$1
- 10° ELECTROLYTICS, to 500mf, asst FP & tubulars \$1
- 50 RADIO & TV KNOBS, asstd. colors & styles . \$1

2N1100 TRANSISTORS

15Amp VCB 100 **1.99**

100 for \$2.98

Power, Audio, RF, untested silicon DNP, npn too!

2N441, 277 . . . \$1

1 AMP 800 PIV SUBMINIATURE RECTIFIERS for \$1

4

MICROAMMETERS

0-100 **2.88**

DC

"N" Channel Fet transistors

2N3085 **1.49**

C-610 **1.49** Each

10¢ GIANT SPRING CATALOG ON: PARTS REC-TIFIERS TRANSISTORS SCRS ZENERS

POLY PAKS

TERMS: send check, money order, include postage—avg. wt. per pak 1 lb. Rated net 30 days. CODs 25%.

P.O. BOX 942R
50. LYNNFIELD, MASS.
"PAK-KING" of the World

Circle 125 on reader's service card

INTERNATIONAL FREQUENCY METERS

designed for servicing!

Equip your lab or service bench with the finest

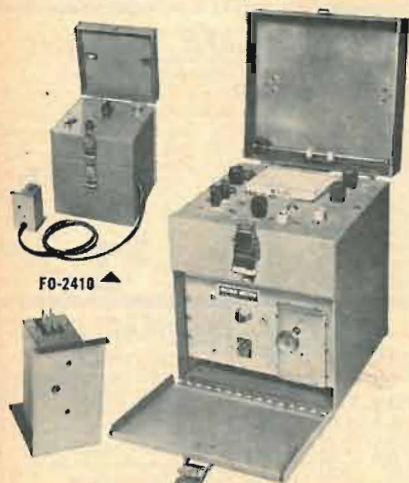

FM-5000 FREQUENCY METER 25 MC to 470 MC

The FM-5000 is a beat frequency measuring device incorporating a transistor counter circuit, low RF output for receiver checking, transmitter keying circuit, audio oscillator, self contained batteries, plug-in oscillators with heating circuits covering frequencies from 100 kc to 60 mc. Stability: $\pm .00025\%$ $+85^\circ$ to $+95^\circ\text{F}$, $\pm .0005\%$ $+50^\circ$ to $+100^\circ\text{F}$, $\pm .001\%$ $+32^\circ$ to $+120^\circ\text{F}$. A separate oscillator (FO-2410) housing 24 crystals and a heater circuit is available. Shipping weight: 18 lbs.

FM-5000 with batteries, accessories, less oscillators and crystals.
Cat. No. 620-103.....\$375.00

Plug-in oscillators with crystals \$20.00 to \$50.00



C-12M FREQUENCY METER For Marine Band Servicing

The C-12M is a portable secondary standard for servicing radio transmitters and receivers in the 2 mc to 15 mc range. The meter has sockets for 24 crystals. Frequency stability is $\pm .0025\%$ 32° to 125°F , $\pm .0015\%$ 50° to 100°F . The C-12M has a built-in transistorized frequency counter circuit, AM percentage modulation checker and modulation carrier and relative percentage field strength. Shipping wt. 9 lbs.

C-12M with PK (pick-off) box and connecting cable, batteries, but less crystals.
Cat. No. 620-104.....\$235.00
Crystals for C-12M (specify frequency) \$7.00 to \$10.00

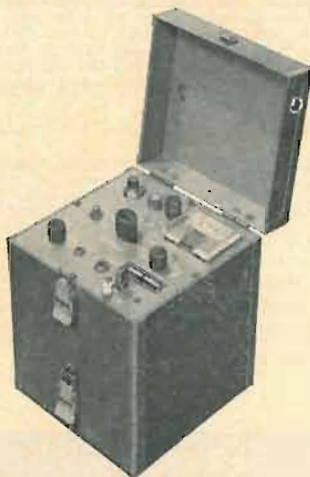

Model 7212 FREQUENCY METER

The International Model 7212 portable secondary frequency standard is a self contained unit designed for servicing radio transmitters and receivers used in the 400 kc to 500 kc range (can be modified for other frequencies on special order). Frequency accuracy is $\pm .01\%$ from 32°F to 104°F (0°C to 40°C). The meter holds eight crystals. Features include the transistorized frequency oscillator and built-in battery charger. Shipping weight: 18 lbs.

Model 7212 complete with crystals.
Cat. No. 620-105.....\$575.00



CRYSTAL CONTROLLED C-12 ALIGNMENT OSCILLATOR

The International C-12 alignment oscillator provides a standard for alignment of IF and RF circuits 200 kc to 60 mc. It makes the 12 most used frequencies instantly available through 12 crystal positions 200 kc to 15,000 kc. Special oscillators are available for use at the higher frequencies to 60 mc. Maximum output .6 volt. Power requirements: 115 vac. Shipping wt. 9 lbs.

C-12 complete, but less crystals.
Cat. No. 620-100.....\$ 69.50

Write today for our
FREE CATALOG

Circle 148 on reader's service card



Model 1110 SECONDARY FREQUENCY STANDARD

The Model 1110 is an economy portable secondary standard for field or bench use with self contained battery. Using any general coverage communications receiver the unit provides the necessary standard signal for measuring frequencies. Easily calibrated against WWV to provide an accuracy of 1×10^6 . Long term stability of ± 10 cycles over range 40°F to 100°F . All transistor circuits provide outputs at 1 mc, 100 kc and 10 kc. Zero adjustment for oscillator on front panel. SHIPPING WEIGHT — 12 lbs.

Model 1110 complete.
Cat. No. 620-106.....\$125.00



C-12B FREQUENCY METER For Citizens Band Servicing

This extremely portable secondary frequency standard is a self contained unit for servicing radio transmitters and receivers used in the 27 mc Citizens Band. The meter is capable of holding 24 crystals and comes with 23 crystals installed. The 23 crystals cover Channel 1 through 23. The frequency stability of the C-12B is $\pm .0025\%$ 32° to 125°F , $\pm .0015\%$ 50° to 100°F . Other features include a transistorized frequency counter circuit, AM percentage modulation checker and power output meter. Shipping weight: 9 lbs.

C-12B with PK (pick-off) box, dummy load, connecting cable, crystals, batteries.
Cat. No. 620-101.....\$300.00

KEEPING YOU ON FREQUENCY IS OUR BUSINESS . . .

INTERNATIONAL
CRYSTAL MFG. CO., INC.
18 NO. LEE • OKLA. CITY, OKLA. 73102

Another great new sales booster from Cornell-Dubilier!

This new and completely revised 16-page booklet is a hard working sales tool. It explains to your customers—in non-technical language—how and why their TV and FM reception can be improved with a CDE Antenna Rotor System.

The booklet is designed to help you convince

buyers of new color TV sets—as well as the present owners of FM and Black-and-White sets—that they should consider a high quality CDE Rotor System.

Make sure you have enough copies on hand. They're available free of charge. Ask for your supply today.



CDE **CORNELL-DUBILIER**



No color?

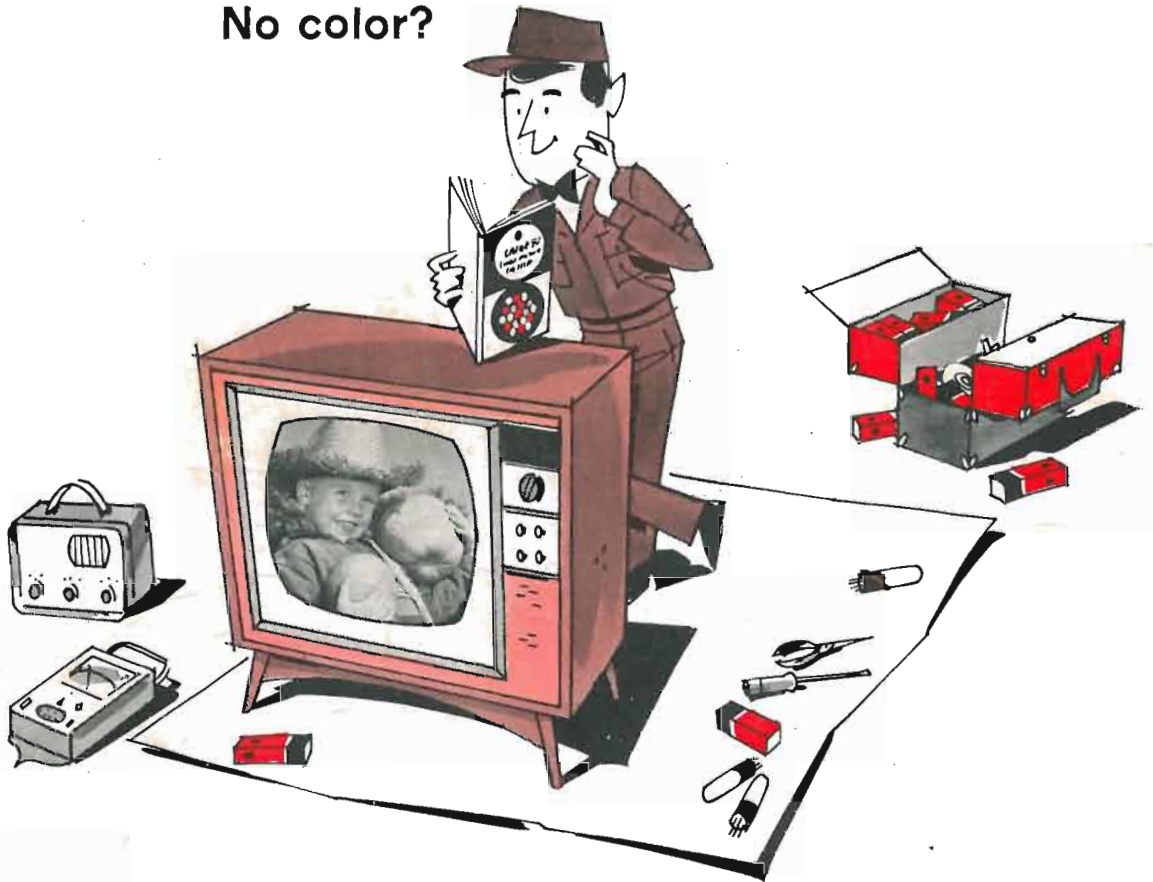

Use this procedure to narrow down the trouble area...

If the receiver produces a normal black-and-white picture but no color during a color broadcast, try the following steps, in order:

1. Tune to a channel broadcasting color, or feed an rf color-bar signal into the antenna terminals.
2. See that the fine-tuning and color (saturation) controls are correctly set.
3. Rotate the color-killer threshold adjustment in the direction which disables the color-killer stage. If locked-in (in sync) color appears, reset this control as recommended by the set manufacturer.
4. If color appears out of sync, look for trouble in the automatic frequency and phase control (AFPC) circuits. Use a color-bar generator, and follow the AFPC adjustment procedures described in the manufacturer's service notes.
5. If no color appears, determine whether the color is lost in the circuits which handle the composite signal (antenna to bandpass amplifier) or in circuits that handle the separated color signal, as follows:
6. Feed a color-bar signal into the antenna terminals

and use a scope to check the composite signal at the video detector.

7. If color-bar waveforms are absent or badly distorted, check for trouble, including poor band-pass, between the antenna terminals and video detector.
8. If color-bar signals are present at the video detector, check the burst keyer or separator, band-pass amplifier, color-killer, and the 3.58 MHz oscillator stages and their associated circuits.
9. Once the operative stage is found, use voltage and resistance measurements to pinpoint the circuit defect.

This ad is still another in a series of color TV service hints from RCA. To keep your customers satisfied, always replace with RCA receiving tubes. Your local RCA Distributor is your best source for top quality receiving tubes for color TV.

RCA ELECTRONIC COMPONENTS AND DEVICES, HARRISON, N. J.



The Most Trusted Name in Electronics